

nidi

elements



nidi



INDICE

CONTENTS

elements

L'indice sempre a portata di mano!
Contents always at your fingertips!



INDICE

CONTENTS

- 01 LETTI / BEDS**
- 02 ACCESSORI LETTO / BED ACCESSORIES**
- 03 COMODINI / BEDSIDE TABLES**
- 04 SCRITTOI / DESKS**
- 05 SEDUTE / SEATING**
- 06 COMPLEMENTI / COMPLEMENTS**
- 07 LIBRERIE / BOOKCASES**
- 08 MENSOLE E CASELLARI / SHELVES AND WALL UNITS**
- 09 SISTEMA LOOP / LOOP SYSTEM**
- 10 BOISERIE / WALL PANELLING**
- 11 ARMADI / WARDROBES**
- 12 PONTI / BRIDGING UNITS**
- 13 CABINE / WALK-IN CLOSETS**
- 14 BASI, CONTENITORI, ALZATE E PENSILI / BASE, STORAGE, TOP AND WALL UNITS**
- 15 MANIGLIE / HANDLES**

INDICE

CONTENTS

- 01 LETTI / BEDS**
 - 08 Letti componibili / Modular beds
 - 30 Letti imbottiti / Padded beds
 - 36 Turche e Sommier / Platform and divan beds
 - 46 Letti a divano / Sofa beds
 - 56 Letti rialzati / Raised beds
 - 64 Letti a castello e Camelot / Bunk and Camelot beds
 - 80 Letti a soppalco / Loft beds
 - 92 Letto a baldacchino Kap / Kap four-poster bed
 - 94 Sistema Regoli / Regoli system
 - 108 Letti a ribalta Twiddy / Twiddy drop-down beds
- 02 ACCESSORI LETTO / BED ACCESSORIES**
 - 114 Reti e cassetti estraibili / Pull-out mattress bases and drawers
 - 116 Elementi retroletto / Rear-bed storage units
 - 118 Protezioni per letti / Bed guards
 - 122 Elementi di salita / Ladders and steps
- 03 COMODINI / BEDSIDE TABLES**
 - 130 Comodini P 45,4 / Bedside tables D 45,4
 - 134 Elemento Jack / Jack unit
 - 136 Comodini Wilson / Wilson bedside tables
 - 138 Comodini Luce / Luce bedside tables
 - 140 Comodini Soft / Soft bedside tables
 - 141 Casellari sospesi Luce / Luce wall units
 - 142 Comodini Becky / Becky bedside tables
 - 143 Tavolini Laby / Laby side tables
 - 144 Panche / Benches
 - 146 Tavolini e vassoi / Side tables and trays

- 04 SCRITTOI / DESKS**
 - 150 Scrittoi / Desks
 - 156 Scrittoi sp. 3 - 5 cm / Desks 3 - 5 cm thick
 - 166 Piani sospesi con alzata / Wall-mounted tops with upstand

- 05 SEDUTE / SEATING**
 - 170 Sedie / Chairs
 - 179 Sgabelli / Stools

- 06 COMPLEMENTI / COMPLEMENTS**
 - 182 Pouf / Ottomans-floor cushions
 - 188 Cassapanche / Chests
 - 190 Portagiochi / Toy boxes
 - 190 Scalette a muro / Wall ladders
 - 190 Appendiabiti / Coat hooks

- 192 Tappeti / Rugs
- 198 Stickers / Stickers
- 202 Carte da parati / Wallpaper
- 212 Specchiere / Mirrors

- 07 LIBRERIE / BOOKCASES**
 - 216 Librerie Luce sp. 1,8 cm / Luce bookcases 1,8 cm thick
 - 226 Librerie Holly sp. 3 cm / Holly bookcases 3 cm thick
 - 248 Librerie Surf / Surf bookcases
- 08 MENSOLE E CASELLARI / SHELVES AND WALL UNITS**
 - 256 Mensole sp. 3 - 5 cm / Shelves 3 - 5 cm thick
 - 258 Mensole Hook / Hook shelves
 - 258 Mensole Poppy / Poppy shelves
 - 260 Casellari Lippy / Lippy wall units
 - 260 Casellari Cloud / Cloud wall units
 - 261 Mensola Kam / Kam shelf
 - 262 Casellari Luce / Luce wall units
 - 264 Casellari Tynn / Tynn wall units
 - 266 Casellari Boxy / Boxy wall units
 - 267 Casellari Pitagora / Pitagora wall units

- 09 SISTEMA LOOP / LOOP SYSTEM**
 - 270 Componenti / Components
 - 278 Elementi free-standing / Freestanding items
- 10 BOISERIE / WALL PANELLING**
 - 286 Boiserie Wally / Wally wall panelling
 - 292 Boiserie Becky / Becky wall panelling
 - 300 Boiserie Dots / Dots wall panelling

- 11 ARMADI / WARDROBES**
 - 306 Armadi battenti / Hinged door wardrobes
 - 332 Armadi scorrevoli / Sliding door wardrobes

- 12 PONTI / BRIDGING UNITS**
 - 348 Ponti / Bridging units

- 13 CABINE / WALK-IN CLOSETS**
 - 364 Cabina Demo a spalla / Demo walk-in closet system with load-bearing side panels
 - 374 Chiusure / Closing systems

- 14 BASI, CONTENITORI, ALZATE E PENSILI / BASE, STORAGE, TOP AND WALL UNITS**
 - 382 Basi / Base units
 - 386 Contenitori e alzate / Storage and top units
 - 390 Pensili / Wall units
 - 394 Woody

- 15 MANIGLIE / HANDLES**
 - 402 Maniglie / Handles

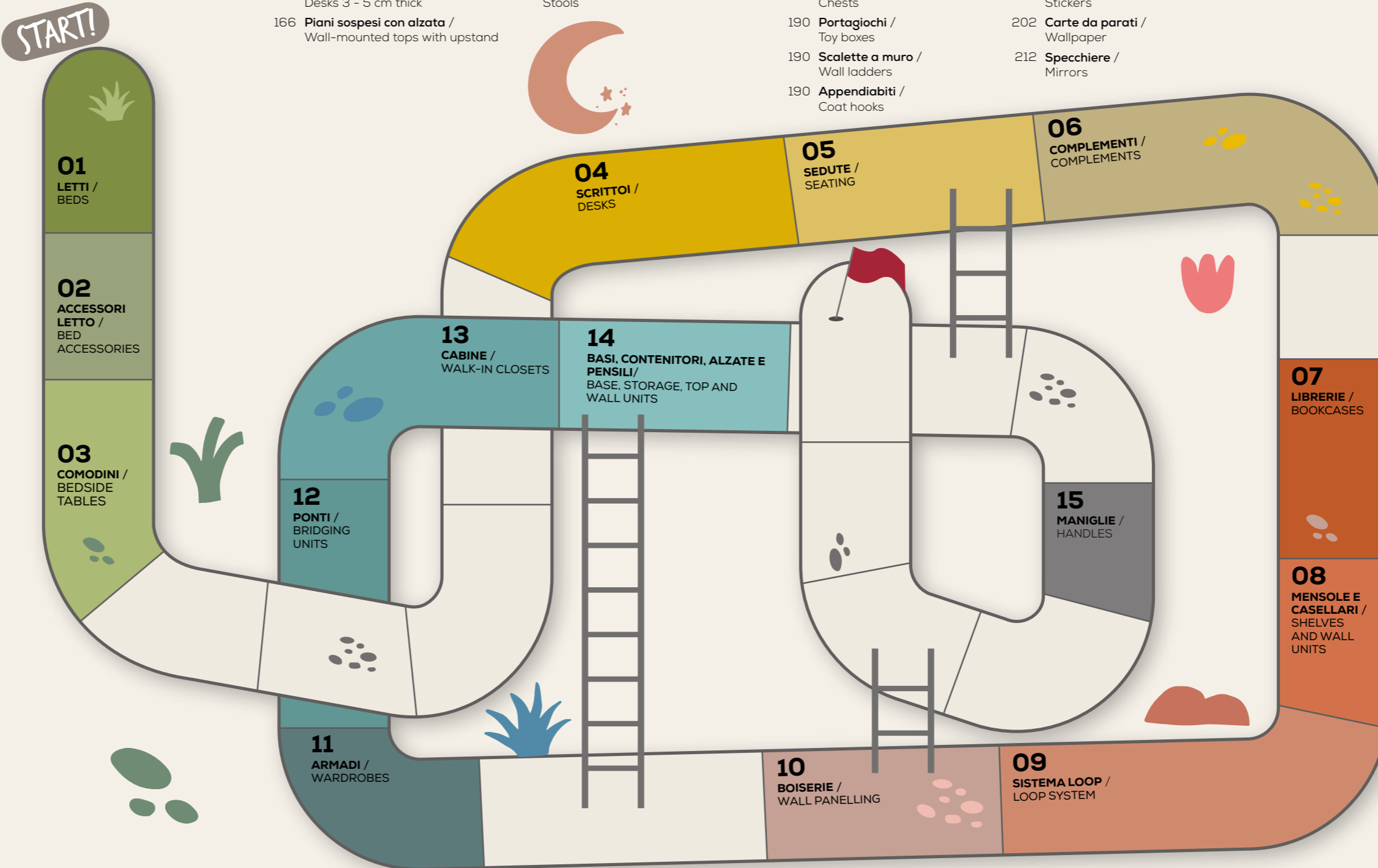

elements

LETTI BEDS

Dormire, leggere, divertirsi, sognare: la camera da letto non è solo uno spazio per il riposo, ma un ambiente da vivere a 360 gradi. Scegliendo gli elementi giusti è possibile personalizzare ogni dettaglio, creando un'atmosfera unica e funzionale, perfetta per riflettere la propria personalità e soddisfare tutte le esigenze quotidiane.

Sleeping, reading, having fun, dreaming: the bedroom is more than just a place for rest, it's a room for living from day to night. By choosing the right elements, every detail of the room can be tailored to suit its occupants, creating a unique and functional interior that perfectly reflects your personality and caters to every daily requirement.

01 LETTI / BEDS



08 **Letti componibili /**
Modular beds



30 **Letti imbottiti /**
Padded beds



36 **Turche e Sommier /**
Platform and divan beds



46 **Letti a divano /**
Sofa beds



56 **Letti rialzati /**
Raised beds



64 **Letti a castello e Camelot /**
Bunk and Camelot beds



80 **Letti a soppalco /**
Loft beds



92 **Letto a baldacchino Kap /**
Kap four-poster bed



94 **Sistema Regoli /**
Regoli system



108 **Letti a ribalta Twiddy /**
Twiddy drop-down beds

START!

LETTI componibili / MODULAR BEDS



I letti componibili offrono una soluzione versatile per ogni ambiente. Grazie alla modularità, è possibile combinare diversi elementi per creare composizioni su misura. Con testiere, piedini e giroletti a scelta, è facile armonizzare lo stile e ottimizzare lo spazio, sfruttando cassetti e contenitori per una maggiore funzionalità.

Modular beds offer a versatile solution for every room. The modular design means different elements can be put together to create custom configurations. With a range of headboards, feet and bed surrounds to choose from, it's easy to pull together a cohesive look and optimize the space, leveraging drawers and storage units for even more functionality.

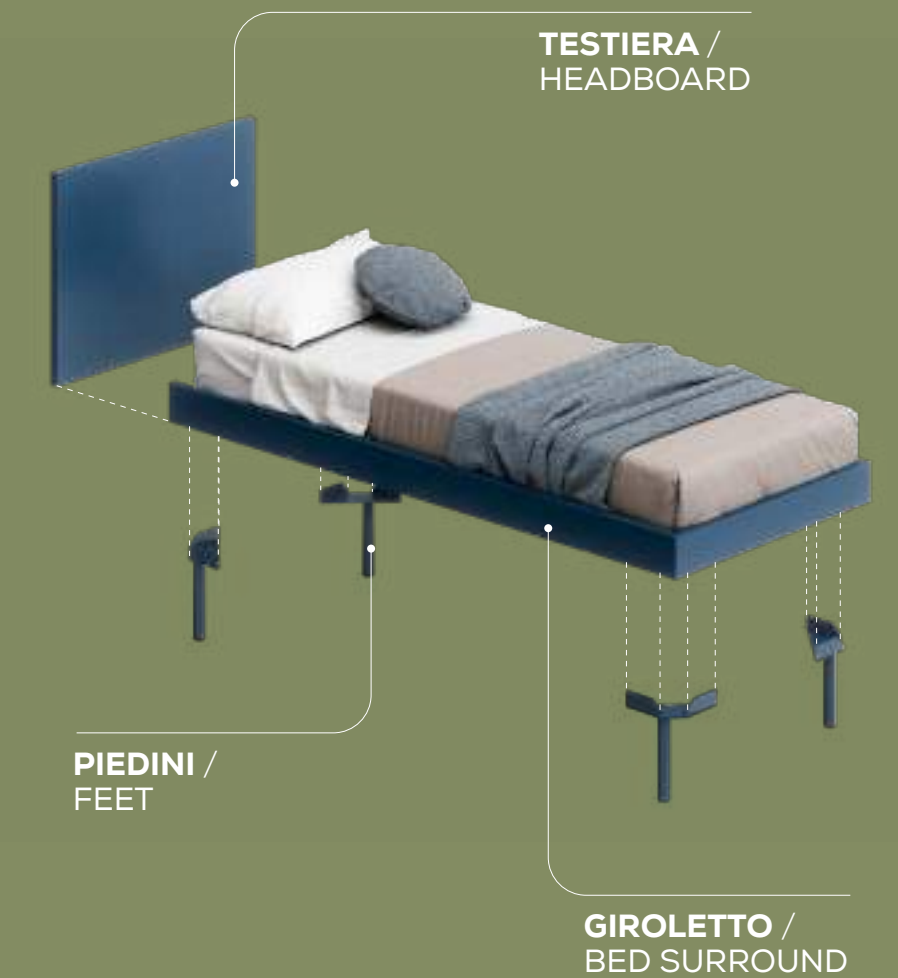
LETTI componibili /
MODULAR BEDS

LETTI COMPONIBILI / MODULAR BEDS



GIROLETTI CON PIEDINI BED SURROUNDS ON FEET

I piedini per letti componibili creano un equilibrio tra estetica e praticità e sono disponibili in forme e materiali diversi. / The feet for modular beds strike a balance between looks and practicality and come in different shapes and materials.

Nobilitato dritto / Straight foil wrapped

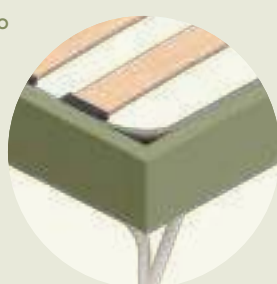

Nobilitato stondato / Rounded foil wrapped

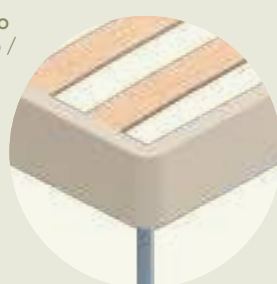

Imbottito / Padded



ROLL



LABY



CACTUS



DOTS



Disponibile solo per larghezze reti 90 e 120 cm. / Only available for 90 and 120 cm mattress base widths.

WOODY



LOLLY



WILL



GIROLETTI BED SURROUNDS

Il giroletto completa la struttura del letto, fornendo sia stabilità che un tocco decorativo. Proposto in varie dimensioni e materiali, si adatta facilmente a diverse configurazioni. Molti modelli includono contenitori, offrendo una soluzione ideale per ottimizzare lo spazio. / The bed surround completes the bed frame, providing both stability and a decorative touch. With a range of sizes and materials to choose from, it lends itself effortlessly to different configurations. Many models include storage bases, offering an ideal solution for optimizing space.

Pediera bassa / Low footboard



Pediera alta / High footboard



Giroletto con piedini / Bed surround with feet



Contenitore / Storage base

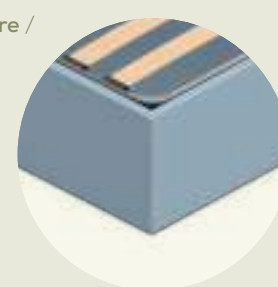

Contenitore stondato / Rounded storage base



Contenitore imbottito / Padded storage base



TESTIERE HEADBOARDS

Le testiere dei letti componibili offrono comfort e stile. Con una varietà di design e finiture, forniscono un supporto ergonomico ideale per il relax e possono essere abbinati a diversi giroletti. / Headboards designed for modular beds offer comfort and style. With an array of designs and finishes, they provide ergonomic support that's just perfect for relaxing and can be paired with different bed surrounds.

NUK



FIT

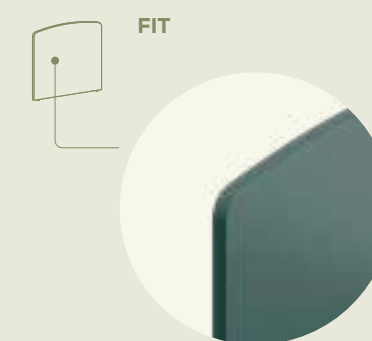

TURN

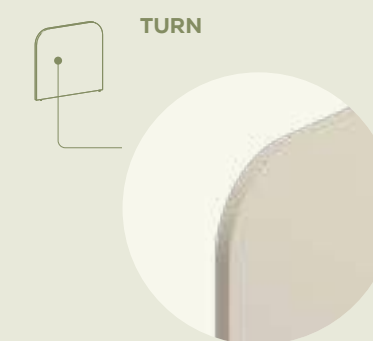

ERGO



HUG



CLEO



LILA

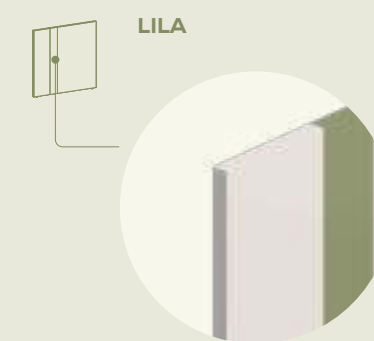

FLARE



PILLOW



LETTI componibili / MODULAR BEDS

LETTO NUK / NUK BED



FINITURE / FINISHES

La struttura è disponibile in tutte le finiture, e i vari componenti possono essere personalizzati anche con finiture diverse tra loro. / The frame is available in any of the finishes, and the various components can be chosen for a personalized look, even mixing different finishes.

RETI E MATERASSI / MATTRESS BASES AND MATTRESSES

L / W 80, 90, 100, 120 cm
P / D 190, 200, 220 cm

CUFFIE E CUSCINI COPRITESTIERA / HEADBOARD COVERS AND CUSHIONS



NUK R01



NUK R02



NUK R03



NUK R04



NUK R04-S



Gambe disponibili: / Leg options: Roll, Laby, Cactus, Dots (solo per larghezze reti 90 e 120 cm), Will, Woody, Lolly, / Roll, Laby, Cactus, Dots (for 90 and 120 cm mattress base widths only), Will, Woody, Lolly.

Gambe disponibili: / Leg options: Roll, Laby, Cactus, Dots (solo per larghezze reti 90 e 120 cm), Will, Woody, Lolly, / Roll, Laby, Cactus, Dots (for 90 and 120 cm mattress base widths only), Will, Woody, Lolly.

NUK R28-S - R38-S



R28-S è disponibile per le larghezze 88, 98, 128 cm, mentre R38-S per le larghezze 88, 98 cm. Sono disponibili entrambi per le profondità 199, 209 cm. / R28-S is available for 88, 98 and 128 cm widths, while R38-S can be used with 88 and 98 cm widths. Both are available for 199 and 209 cm depths.

* Scopri come attrezzare i letti con reti e cassetti estraibili H 29,2 a pag. 115 nella sezione accessori letto. / See how beds can be fitted with pull-out mattress bases and 29,2cm-high drawers on page 115 in the bed accessories section.

LETTI componibili / MODULAR BEDS

LETTO ERGO / ERGO BED



FINITURE / FINISHES

La struttura è disponibile in tutte le finiture, e i vari componenti possono essere personalizzati anche con finiture diverse tra loro. / The frame is available in any of the finishes, and the various components can be chosen for a personalized look, even mixing different finishes.

RETI E MATERASSI / MATTRESS BASES AND MATTRESSES

L / W 80, 90, 100, 120 cm
P / D 190, 200, 220 cm

CUFFIE E CUSCINI COPRITESTIERA / HEADBOARD COVERS AND CUSHIONS



ERGO R01



ERGO R02



ERGO R04



ERGO R04-S



Gambe disponibili: / Leg options: Roll, Laby, Cactus, Dots (solo per larghezze reti 90 e 120 cm), Will, Woody, Lolly. / Roll, Laby, Cactus, Dots (for 90 and 120 cm mattress base widths only), Will, Woody, Lolly.

Gambe disponibili: / Leg options: Roll, Laby, Cactus, Dots (solo per larghezze reti 90 e 120 cm), Will, Woody, Lolly. / Roll, Laby, Cactus, Dots (for 90 and 120 cm mattress base widths only), Will, Woody, Lolly.

ERGO R03



ERGO R28-S - R38-S



R28-S è disponibile per le larghezze 88, 98, 128 cm, mentre R38-S per le larghezze 88, 98 cm. Sono disponibili entrambi per le profondità 199, 209 cm. / R28-S is available for 88, 98 and 128 cm widths, while R38-S can be used with 88 and 98 cm widths. Both are available for 199 and 209 cm depths.

* Scopri come attrezzare i letti con reti e cassetti estraibili H 29,2 a pag. 115 nella sezione accessori letto. / See how beds can be fitted with pull-out mattress bases and 29,2cm-high drawers on page 115 in the bed accessories section.

LETTI componibili / MODULAR BEDS

LETTO LILA / LILA BED



FINITURE / FINISHES

La struttura è disponibile in tutte le finiture, e i vari componenti possono essere personalizzati anche con finiture diverse tra loro. / The frame is available in any of the finishes, and the various components can be chosen for a personalized look, even mixing different finishes.

RETI E MATERASSI / MATTRESS BASES AND MATTRESSES

L / W 80, 90, 120 cm
P / D 190, 200, 220 cm

CUSCINI COPRITESTIERA / HEADBOARD COVER CUSHIONS

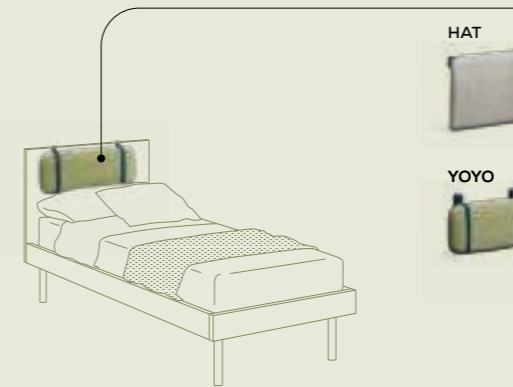

LILA R01



LILA R02



LILA R04



LILA R04-S



Gambe disponibili: / Leg options:
Roll, Laby, Cactus, Dots (solo per larghezze reti 90 e 120 cm), Will, Woody, Lolly. / Roll, Laby, Cactus, Dots (for 90 and 120 cm mattress base widths only), Will, Woody, Lolly.

Gambe disponibili: / Leg options:
Roll, Laby, Cactus, Dots (solo per larghezze reti 90 e 120 cm), Will, Woody, Lolly. / Roll, Laby, Cactus, Dots (for 90 and 120 cm mattress base widths only), Will, Woody, Lolly.

LILA R03



LILA R28-S



R28-S è disponibile per le larghezze 88, 98, 128 cm e per le profondità 199, 209 cm. / R28-S is available for 88, 98 and 128 cm widths and for 199 and 209 cm depths.

* Scopri come attrezzare i letti con reti e cassetti estraibili H 29,2 a pag. 115 nella sezione accessori letto. / See how beds can be fitted with pull-out mattress bases and 29,2cm-high drawers on page 115 in the bed accessories section.

LETTI componibili / MODULAR BEDS

LETTO FIT / FIT BED



CUSCINI COPRITESTIERA / HEADBOARD COVER CUSHIONS

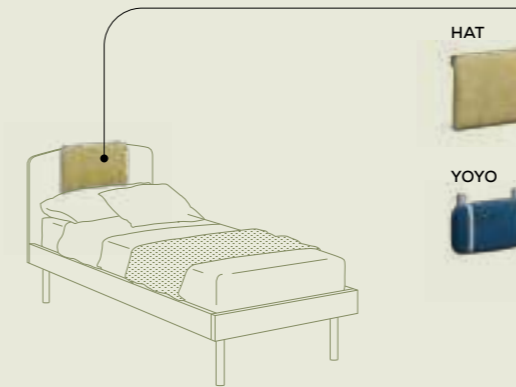

FIT R01



FIT R02



FIT R04



FIT R04-S



FIT R03



FIT R28-S - R38-S



* Scopri come attrezzare i letti con reti e cassetti estraibili H 29,2 a pag. 115 nella sezione accessori letto. / See how beds can be fitted with pull-out mattress bases and 29,2cm-high drawers on page 115 in the bed accessories section.

R28-S è disponibile per le larghezze 88, 98, 128 cm, mentre R38-S per le larghezze 88, 98 cm. Sono disponibili entrambi per le profondità 199, 209 cm. / R28-S is available for 88, 98 and 128 cm widths, while R38-S can be used with 88 and 98 cm widths. Both are available for 199 and 209 cm depths.

LETTI componibili / MODULAR BEDS

LETTO TURN / TURN BED



FINITURE / FINISHES

La struttura è disponibile in tutte le finiture, e i vari componenti possono essere personalizzati anche con finiture diverse tra loro. / The frame is available in any of the finishes, and the various components can be chosen for a personalized look, even mixing different finishes.

RETI E MATERASSI / MATTRESS BASES AND MATTRESSES

L / W 80, 90, 100, 120 cm
P / D 190, 200, 220 cm

CUSCINI COPRITESTIERA / HEADBOARD COVER CUSHIONS

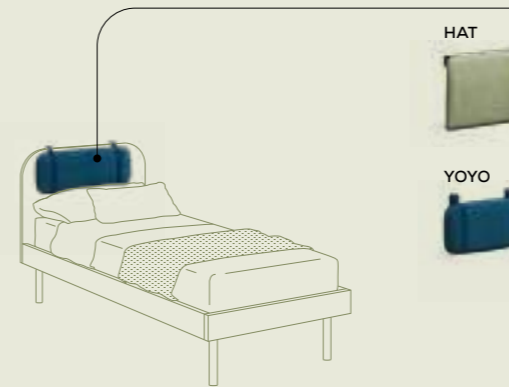

TURN R01



TURN R02



TURN R04



TURN R04-S



Gambe disponibili: / Leg options:
Roll, Laby, Cactus, Dots (solo per larghezze reti 90 e 120 cm), Will, Woody, Lolly, / Roll, Laby, Cactus, Dots (for 90 and 120 cm mattress base widths only), Will, Woody, Lolly.

Gambe disponibili: / Leg options:
Roll, Laby, Cactus, Dots (solo per larghezze reti 90 e 120 cm), Will, Woody, Lolly, / Roll, Laby, Cactus, Dots (for 90 and 120 cm mattress base widths only), Will, Woody, Lolly.

TURN R03



TURN R28-S - R38-S



R28-S è disponibile per le larghezze 88, 98, 128 cm, mentre R38-S per le larghezze 88, 98 cm. Sono disponibili entrambi per le profondità 199, 209 cm. / R28-S is available for 88, 98 and 128 cm widths, while R38-S can be used with 88 and 98 cm widths. Both are available for 199 and 209 cm depths.

* Scopri come attrezzare i letti con reti e cassetti estraibili H 29,2 a pag. 115 nella sezione accessori letto. / See how beds can be fitted with pull-out mattress bases and 29,2cm-high drawers on page 115 in the bed accessories section.

LETTI componibili / MODULAR BEDS

CUFFIE E CUSCINI COPRITESTIERA /
HEADBOARD COVERS AND CUSHIONS**ZIPPER**

Cuffia / Headboard cover

Disponibile per: / Available for:
Ergo**CROSS**

Cuffia / Headboard cover

Disponibile per: / Available for:
Nuk**HAT**Cuscino copritestiera /
Headboard cover cushion

60x35 cm

Disponibile per: / Available for:
Nuk, Ergo, Lila, Fit, Turn**YOYO**Cuscino copritestiera /
Headboard cover cushion

65x25 cm

Disponibile per: / Available for:
Nuk, Ergo, Lila, Fit, Turn**CHUBBY**

Cuffia / Headboard cover

P/D 60 cm

Disponibile per: / Available for:
Nuk**POCKET**

Cuffia / Headboard cover

Disponibile per: / Available for:
Nuk**ZIGGY**

Cuffia / Headboard cover

Disponibile per: / Available for:
Nuk**CLUB**

Cuffia / Headboard cover

P/D 60 cm

Disponibile per: / Available for:
Nuk**FRAME**

Cuffia / Headboard cover

Disponibile per: / Available for:
Nuk, Ergo**REGULAR**

Cuffia / Headboard cover

P/D 60 cm

Disponibile per: / Available for:
Nuk

LETTI componibili / MODULAR BEDS

LETTO HUG / HUG BED

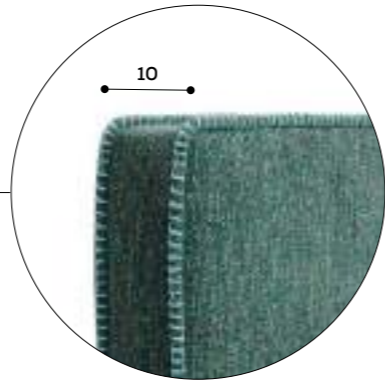

FINITURE / FINISHES

Testiera disponibile in tutti i tessuti e sfoderabile. La struttura è disponibile in tutte le finiture, e i vari componenti possono essere personalizzati anche con finiture diverse tra loro. / Headboard available in all fabrics and with removable cover. The frame is available in all fabrics and finishes, and the various components can be chosen for a personalized look, even mixing different finishes.

RETI E MATERASSI / MATTRESS BASES AND MATTRESSES

L / W 80, 90, 100, 120 cm
P / D 190, 200, 220 cm



HUG R03



HUG R06



Non disponibile per profondità 236 cm. / Not an option for 236 cm depth.

HUG R09



Non disponibile per profondità 236 cm. / Not an option for 236 cm depth.

HUG R04



HUG R04-S



Gambe disponibili: / Leg options: Roll, Laby, Cactus, Dots (solo per larghezze reti 90 e 120 cm), Will, Woody, Lolly. / Roll, Laby, Cactus, Dots (for 90 and 120 cm mattress base widths only), Will, Woody, Lolly.

Gambe disponibili: / Leg options: Roll, Laby, Cactus, Dots (solo per larghezze reti 90 e 120 cm), Will, Woody, Lolly. / Roll, Laby, Cactus, Dots (for 90 and 120 cm mattress base widths only), Will, Woody, Lolly.

HUG R28-S - R38-S



HUG R29 - R39

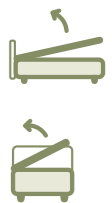

R28-S è disponibile per le larghezze 98, 108, 138 cm, mentre R38-S per le larghezze 98, 108 cm. Sono disponibili entrambi per le profondità 206, 216 cm. / R28-S is available for 98, 108 and 138 cm widths, while R38-S can be used with 98 and 108 cm widths. Both are available for 206 and 216 cm depths.

R29 è disponibile per le larghezze 98, 108, 138 cm, mentre R39 per le larghezze 98, 108 cm. Sono disponibili entrambi per le profondità 206, 216 cm. / R29 is available for 98, 108 and 138 cm widths, while R39 can be used with 98 and 108 cm widths. Both are available for 206 and 216 cm depths.

LETTI componibili / MODULAR BEDS

LETTO FLARE / FLARE BED

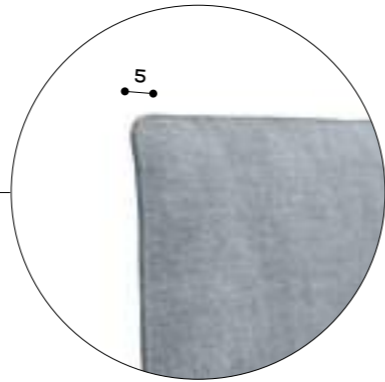

FINITURE / FINISHES

Testiera disponibile in tutti i tessuti. La struttura è disponibile in tutti i tessuti e finiture, e i vari componenti possono essere personalizzati anche con finiture diverse tra loro. / Headboard available in all fabrics. The frame is available in all fabrics and finishes, and the various components can be chosen for a personalized look, even mixing different finishes.

RETI E MATERASSI / MATTRESS BASES AND MATTRESSES

L / W 80, 90, 100, 120 cm
P / D 190, 200, 220 cm



FLARE R03



FLARE R06



Non disponibile per profondità 238 cm. / Not an option for 238 cm depth.

FLARE R09



Non disponibile per profondità 238 cm. / Not an option for 238 cm depth.

FLARE R04



Gambe disponibili: / Leg options:
Roll, Laby, Cactus, Dots (solo per larghezze reti 90 e 120 cm), Will, Woody, Lolly. / Roll, Laby, Cactus, Dots (for 90 and 120 cm mattress base widths only), Will, Woody, Lolly.

FLARE R04-S



Gambe disponibili: / Leg options:
Roll, Laby, Cactus, Dots (solo per larghezze reti 90 e 120 cm), Will, Woody, Lolly. / Roll, Laby, Cactus, Dots (for 90 and 120 cm mattress base widths only), Will, Woody, Lolly.

FLARE R28 - S



R28-S è disponibile per le larghezze 98, 108, 138 cm e per le profondità 208, 218 cm. / R28-S is available for 98, 108 and 138 cm widths and for 208 and 218 cm depths.

FLARE R29



R29 è disponibile per le larghezze 98, 108, 138 cm e per le profondità 208, 218 cm. / R29 is available for 98, 108 and 138 cm widths and for 208 and 218 cm depths.

LETTI componibili / MODULAR BEDS

LETTO CLEO / CLEO BED



FINITURE / FINISHES

Testiera disponibile in tutti i tessuti. La struttura è disponibile in tutti i tessuti e finiture, e i vari componenti possono essere personalizzati anche con finiture diverse tra loro. / Headboard available in all fabrics. The frame is available in all fabrics and finishes, and the various components can be chosen for a personalized look, even mixing different finishes.

RETI E MATERASSI / MATTRESS BASES AND MATTRESSES

L / W 80, 90, 100, 120 cm
P / D 190, 200, 220 cm

LETTO PILLOW / PILLOW BED



FINITURE / FINISHES

Testiera disponibile in tutti i tessuti. La struttura è disponibile in tutti i tessuti e finiture, e i vari componenti possono essere personalizzati anche con finiture diverse tra loro. / Headboard available in all fabrics. The frame is available in all fabrics and finishes, and the various components can be chosen for a personalized look, even mixing different finishes.

RETI E MATERASSI / MATTRESS BASES AND MATTRESSES

L / W 80, 90, 100, 120 cm
P / D 190, 200, 220 cm

CLEO R04



Gambe disponibili: / Leg options:
Roll, Laby, Cactus, Dots (solo per larghezze reti 90 e 120 cm), Will, Woody, Lolly. / Roll, Laby, Cactus, Dots (for 90 and 120 cm mattress base widths only), Will, Woody, Lolly.

CLEO R04-S



Gambe disponibili: / Leg options:
Roll, Laby, Cactus, Dots (solo per larghezze reti 90 e 120 cm), Will, Woody, Lolly. / Roll, Laby, Cactus, Dots (for 90 and 120 cm mattress base widths only), Will, Woody, Lolly.

CLEO R06



Gambe disponibili: / Leg options:
Roll, Laby, Cactus, Dots (solo per larghezze reti 90 e 120 cm), Will, Woody, Lolly. / Roll, Laby, Cactus, Dots (for 90 and 120 cm mattress base widths only), Will, Woody, Lolly.
Non disponibile per profondità 234 cm. / Not an option for 234 cm depth.

PILLOW R04



Gambe disponibili: / Leg options:
Roll, Laby, Cactus, Dots (solo per larghezze reti 90 e 120 cm), Will, Woody, Lolly. / Roll, Laby, Cactus, Dots (for 90 and 120 cm mattress base widths only), Will, Woody, Lolly.

PILLOW R04-S



Gambe disponibili: / Leg options:
Roll, Laby, Cactus, Dots (solo per larghezze reti 90 e 120 cm), Will, Woody, Lolly. / Roll, Laby, Cactus, Dots (for 90 and 120 cm mattress base widths only), Will, Woody, Lolly.

PILLOW R06



Gambe disponibili: / Leg options:
Roll, Laby, Cactus, Dots (solo per larghezze reti 90 e 120 cm), Will, Woody, Lolly. / Roll, Laby, Cactus, Dots (for 90 and 120 cm mattress base widths only), Will, Woody, Lolly.
Non disponibile per profondità 241 cm. / Not an option for 241 cm depth.

LETTI IMBOTTITI / PADDED BEDS



I letti imbottiti offrono un elevato comfort. Personalizzabili in tutti i tessuti nelle diverse nuance, si adattano perfettamente a qualsiasi stile di arredamento. La struttura sfoderabile facilita la manutenzione, mentre la possibilità di scegliere tra vari modelli li rende estremamente versatili.

Padded beds offer supreme comfort. They can be customized in any of the fabric options in the full range of shades and go perfectly with any decor style. The frame's removable covers make for easy care, while having a range of models to choose from makes these beds extremely versatile.

LETTO ARIAL / ARIAL BED



Piedini H 2 cm. / 2cm-high feet.

Letto sfoderabile e disponibile in tutti i tessuti. / Bed with removable covers, available in all fabrics.

Tasca Paddle applicabile con velcro ai longoni imbottiti. / Paddle pocket with Velcro fastening for attachment to upholstered side rails.

Disponibile anche con rete alzante e meccanismo ammortizzato. / Also comes with lift-up mattress base option and soft-closing system.

LETTO WIND / WIND BED



Piedini H 2 cm. / 2cm-high feet.

Letto sfoderabile e disponibile in tutti i tessuti. / Bed with removable covers, available in all fabrics.

Tasca Paddle applicabile con velcro ai longoni imbottiti. / Paddle pocket with Velcro fastening for attachment to upholstered side rails.

Disponibile anche con rete alzante e meccanismo ammortizzato. / Also comes with lift-up mattress base option and soft-closing system.



LETTI IMBOTTITI / PADDED BEDS

LETTO ROLLER / ROLLER BED



Piedini H 6 cm. / 6cm-high feet.

Letto sfoderabile e disponibile in tutti i tessuti. / Bed with removable covers, available in all fabrics.

Tasca Paddle applicabile con velcro ai longoni imbottiti. / Paddle pocket with Velcro fastening for attachment to upholstered side rails.

Disponibile anche con rete alzante e meccanismo ammortizzato. / Also comes with lift-up mattress base option and soft-closing system.

LETTO SWELL / SWELL BED



Piedini H 2 cm. / 2cm-high feet.

Letto sfoderabile e disponibile in tutti i tessuti. / Bed with removable covers, available in all fabrics.

Tasca Paddle applicabile con velcro ai longoni imbottiti. / Paddle pocket with Velcro fastening for attachment to upholstered side rails.

Disponibile anche con rete alzante e meccanismo ammortizzato. / Also comes with lift-up mattress base option and soft-closing system.

TURCHE E SOMMIER / PLATFORM AND DIVAN BEDS



Le turche e i sommier sono perfetti per chi cerca soluzioni compatte e funzionali. I vani sottostanti offrono spazio aggiuntivo per riporre oggetti, rendendoli particolarmente utili in stanze di piccole dimensioni.

Platform and divan beds are perfect if you're looking for compact, functional solutions. The cubbyholes underneath provide extra space for storing personal belongings, making them particularly useful in smaller rooms.

TURCHE E SOMMIER / PLATFORM AND DIVAN BEDS

TURCHE / PLATFORM BEDS



FINITURE / FINISHES

La struttura è disponibile in tutti i tessuti e finiture, e i vari componenti possono essere personalizzati anche con finiture diverse tra loro. / The frame is available in all fabrics and finishes, and the various components can be chosen for a personalized look, even mixing different finishes.

RETI E MATERASSI / MATTRESS BASES AND MATTRESSES

L / W 80, 90, 100, 120 cm
P / D 190, 200, 220 cm



FINITURE / FINISHES

La struttura è disponibile in tutte le finiture, e i vari componenti possono essere personalizzati anche con finiture diverse tra loro. / The frame is available in all finishes, and the various components can be chosen for a personalized look, even mixing different finishes.

RETI E MATERASSI / MATTRESS BASES AND MATTRESSES

L / W 80, 90, 100, 120 cm
P / D 190, 200 cm

TURCA IMBOTTITA / PADDED PLATFORM BED



L/W 98 x P/D 199, 209 x H 41 cm.

R06



P/D 199, 209 x H 35,5 cm.
Gambe disponibili: / Leg options:
Roll, Laby, Cactus, Will, Woody, Lolly.

R03



H 37 cm
Gambe non disponibili in: /
Legs not available in:
olmo, mandorlo, nocciolo.

R04 | R04-S

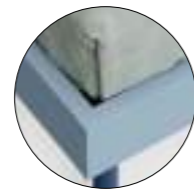

R04

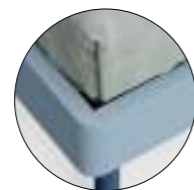

R04-S

H 35,5 cm
Gambe disponibili: / Leg options:
Roll, Laby, Cactus, Dots (solo per larghezze reti 90 e 120 cm), Will, Woody, Lolly. / Roll, Laby, Cactus, Dots (for 90 and 120 cm mattress base widths only), Will, Woody, Lolly.

R04B | R04-SB



R04B



R04-SB

H 27,5 cm
Ruote nei colori: / Colour options for castors:
bianco, lavagna.

NUK R01



H 42 cm

NUK R02

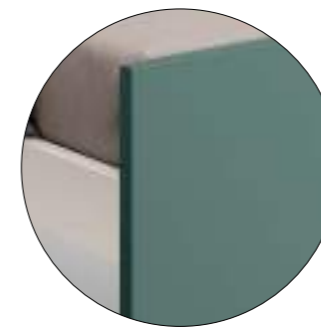

H 58 cm

ERGO R02

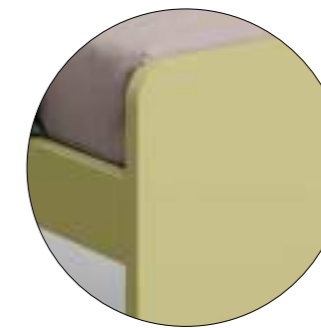

H 58 cm

LILA R02



H 58 cm
Non disponibile per larghezza 108 cm. /
Not an option for 108 cm width.

FIT R02



H 58 cm

TURN R02



H 58 cm

* Scopri come attrezzare i letti con reti e cassetti estraibili H 29,2 a pag. 115 nella sezione accessori letto. / See how beds can be fitted with pull-out mattress bases and 29,2cm-high drawers on page 115 in the bed accessories section.

TURCHE E SOMMIER / PLATFORM AND DIVAN BEDS

TURCHE CON RETE STRUTTURALE /
PLATFORM BEDS WITH STRUCTURAL MATTRESS BASE

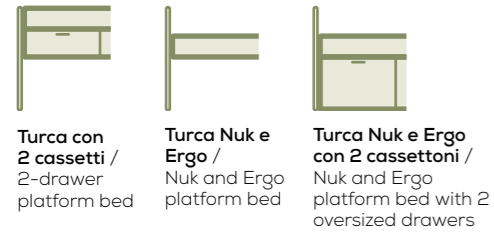

Turca con 2 cassetti / 2-drawer platform bed

Turca Nuk e Ergo / Nuk and Ergo platform bed

Turca Nuk e Ergo con 2 cassettoni / Nuk and Ergo platform bed with 2 oversized drawers

H 58 CM
Turca, Turca Nuk, Turca Ergo / Platform bed, Nuk platform bed, Ergo platform bed
Reti e materassi / Mattress bases and mattresses
L / W 80, 90 cm
P / D 190, 200 cm

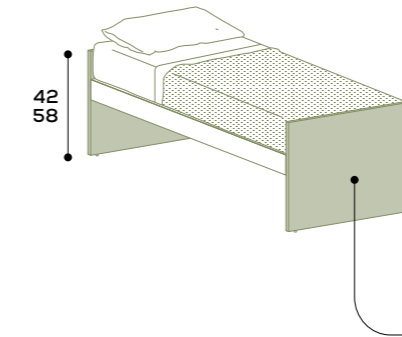

TURCA NUK /
NUK PLATFORM BED

TURCA ERGO /
ERGO PLATFORM BED

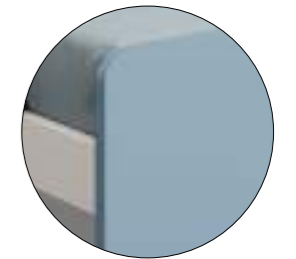
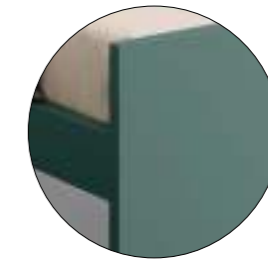

H 42 CM
Turca, Turca Nuk, Turca Ergo / Platform bed, Nuk platform bed, Ergo platform bed
Reti e materassi / Mattress bases and mattresses
L / W 80, 90 cm
P / D 190, 200 cm

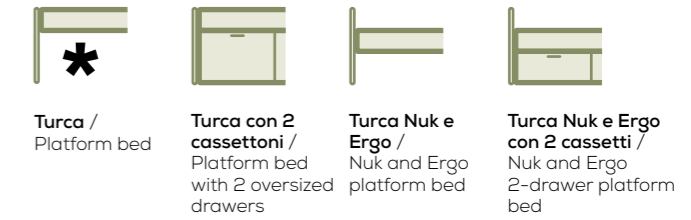

Turca / Platform bed

Turca con 2 cassettoni / Platform bed with 2 oversized drawers

Turca Nuk e Ergo / Nuk and Ergo platform bed

Turca Nuk e Ergo con 2 cassetti / Nuk and Ergo 2-drawer platform bed



H 30 CM
Turca / Platform bed
Reti e materassi / Mattress bases and mattresses
L / W 80, 90 cm

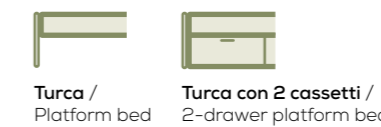

Turca / Platform bed

Turca con 2 cassetti / 2-drawer platform bed

* Scopri come attrezzare i letti con reti e cassetti estraibili H 29,2 a pag. 115 nella sezione accessori letto. / See how beds can be fitted with pull-out mattress bases and 29,2cm-high drawers on page 115 in the bed accessories section.

TURCHE E SOMMIER / PLATFORM AND DIVAN BEDS



SOMMIER / DIVAN BEDS

R28-S - R38-S

Sono disponibili anche la versione W28-S e W38-S, con ruote auto-frenanti incassate unidirezionali. / Version W28-S and W38-S also available, with recessed single-direction self-locking wheels.

Reti e materassi / Mattress bases and mattresses

R28-S	W28-S	R38-S	W38-S
L / W 80, 90, 120 cm	L / W 80, 90 cm	L / W 80, 90 cm	L / W 80, 90 cm
P / D 190, 200 cm	P / D 190, 200 cm	P / D 190, 200 cm	P / D 190, 200 cm



Guarda le aperture dei letti Sommier. / Watch the divan bed opening.



R29

Disponibile anche nella versione R09 senza contenitore. / Also comes in R09 version with no storage base.

Reti e materassi / Mattress bases and mattresses

R29	R09
L / W 80, 90, 120, 160 cm	L / W 80, 90, 100, 120, 160 cm
P / D 190, 200 cm	P / D 190, 200 cm



LETTI A DIVANO / SOFA BEDS



I letti a divano di giorno possono essere usati come comode sedute mentre di notte si trasformano in un letto accogliente. Le sponde imbottite aumentano il comfort, mentre la possibilità di aggiungere una seconda rete estraibile o una rete alzante laterale rende questi letti ideali per ottimizzare lo spazio e accogliere ospiti all'occorrenza.

By day, sofa beds can be used as comfortable seating, while at night they turn into a cosy bed. Sides are padded for added comfort, while the option of adding a trundle bed or a side-lift mattress base makes these beds ideal for optimizing space and accommodating guests when needed.

LETTI A DIVANO / SOFA BEDS

LETTI A DIVANO / SOFA BEDS

**LETTO A DIVANO E 2 CASSETTI /
2-DRAWER SOFA BED**

H 92 cm

Reti e materassi / Mattress bases and mattresses

L / W 80, 90 cm

P / D 190, 200 cm

Disponibile anche con ruote. /
Also comes with the option of wheels.**LETTO A DIVANO CON SCHIENA /
SOFA BED WITH BACKREST**

H 92 cm

Reti e materassi / Mattress bases and mattresses

L / W 80, 90 cm

P / D 190, 200 cm

Disponibile anche con ruote. /
Also comes with the option of wheels.**LETTO A DIVANO CON SCHIENA SAGOMATA E 2 CASSETTONI /
SOFA BED WITH SHAPED BACKREST AND 2 OVERSIZED DRAWERS**

H 92 cm

Reti e materassi / Mattress bases and mattresses

L / W 80, 90 cm

P / D 190, 200 cm

Disponibile anche con ruote. /
Also comes with the option of wheels.

* Scopri come attrezzare i letti con reti e cassetti estraibili H 29,2 a pag. 115 nella sezione accessori letto. /
See how beds can be fitted with pull-out mattress bases and 29,2cm-high drawers on page 115 in the bed accessories section.

LETTI A DIVANO / SOFA BEDS

LETTI A DIVANO IMBOTTITI /
UPHOLSTERED SOFA BEDSLETTO A DIVANO CON SCHIENA /
SOFA BED WITH BACKREST

H 92 cm

Reti e materassi / Mattress bases and mattresses

L / W 90 cm
P / D 190, 200 cm

Rete fissa. / Fixed mattress base.

LETTO A DIVANO CON SCHIENA E FIANCO /
SOFA BED WITH BACKREST AND SIDE

H 92 cm

Reti e materassi / Mattress bases and mattresses

L / W 90 cm
P / D 190, 200 cm

Rete fissa. / Fixed mattress base.

LETTO A DIVANO CON SCHIENA SAGOMATA E FIANCO /
SOFA BED WITH SHAPED BACKREST AND 1 SIDE

H 92 cm

Reti e materassi / Mattress bases and mattresses

L / W 90 cm
P / D 190, 200 cm

Rete alzante laterale. / Side-lift mattress base.

LETTO A DIVANO CON SCHIENA E DUE FIANCHI /
SOFA BED WITH BACKREST AND 2 SIDES

H 73-92 cm

Reti e materassi / Mattress bases and mattresses

L / W 90 cm
P / D 190, 200 cm

Rete alzante laterale. / Side-lift mattress base.



* Scopri come attrezzare i letti con reti e cassetti estraibili H 29,2 a pag. 115 nella sezione accessori letto. /
See how beds can be fitted with pull-out mattress bases and 29,2cm-high drawers on page 115 in the bed accessories section.



LETTI A DIVANO / SOFA BEDS

LETTO A DIVANO PABLO / PABLO SOFA BED



Reti e materassi / Mattress bases and mattresses
L / W 90 cm
P / D 190, 200 cm

* Scopri come attrezzare i letti con reti e cassetti estraibili H 29,2 a pag. 115 nella sezione accessori letto. / See how beds can be fitted with pull-out mattress bases and 29,2cm-high drawers on page 115 in the bed accessories section.

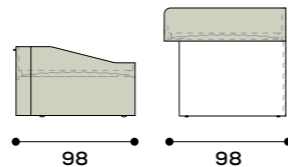

Entrambi i letti hanno la stessa larghezza. / Both beds are the same width.

LETTO A DIVANO BUG / BUG SOFA BED

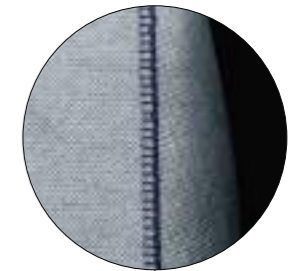

Reti e materassi / Mattress bases and mattresses
L / W 80, 90 cm
P / D 190, 200 cm

Sono disponibili le gambe Roll, Lolly, Cactus, Laby, Will e Woody. / Choose from Roll, Lolly, Cactus, Laby, Will and Woody legs.

LETTI RIALZATI / RAISED BEDS



I letti rialzati ottimizzano gli spazi, offrendo soluzioni intelligenti per ambienti ridotti. Cassetti, scalette e scrittoi integrati rendono questi letti funzionali e pratici per organizzare al meglio lo spazio per dormire, studiare e giocare.

Raised beds optimize spaces, offering smart solutions for smaller rooms. Drawers, steps and built-in desks make these beds functional and practical, for an organized solution that makes the most of the space for sleeping, studying and playing.

LETTI RIALZATI / RAISED BEDS

H 92 CM

ATTEZZABILI CON LETTI TURCA H 30 CM /
CAN INCORPORATE 30CM-HIGH PLATFORM BEDS

SCHIENA E DUE FIANCHI /
BACK AND TWO SIDE PANELS

Reti e materassi / Mattress bases and mattresses
L / W 80, 90 cm
P / D 200 cm



SCHIENA E FIANCO /
BACK AND SIDE PANEL

Reti e materassi / Mattress bases and mattresses
L / W 80, 90 cm
P / D 200 cm



* Attezzabile con letti turca H 30 cm o con turca R04B e R04-SB. /
Bed can accommodate 30cm-high platform beds or with R04B and R04-SB platform beds.

SCHIENA SAGOMATA E UN FIANCO /
SHAPED BACK AND ONE SIDE PANEL

Reti e materassi / Mattress bases and mattresses
L / W 80, 90 cm
P / D 200 cm

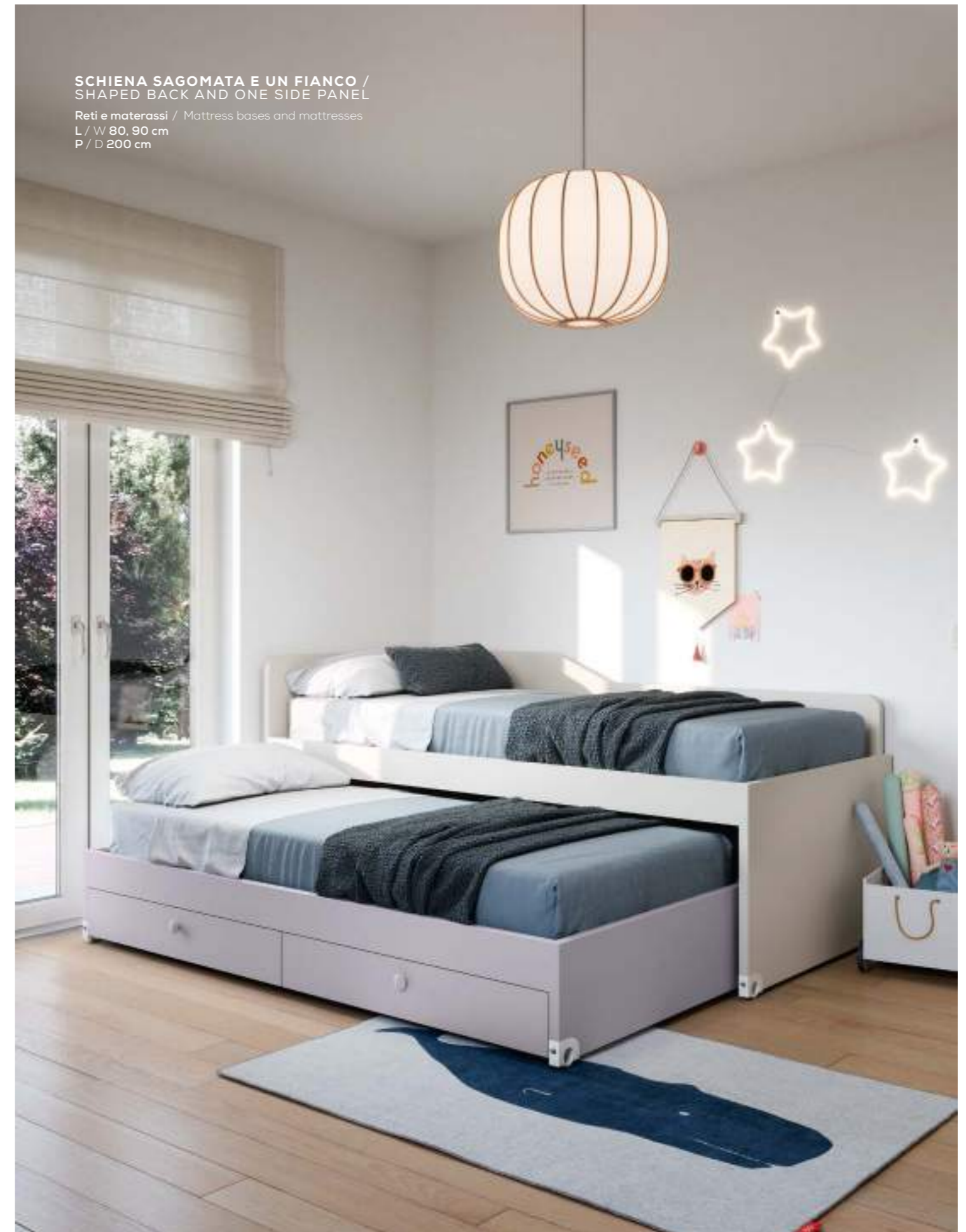

LETTI RIALZATI / RAISED BEDS

H 119 CM

**ATTREZZABILI CON LETTI TURCA FINO AD H 58 CM /
BED CAN ACCOMODATED PLATFORM BEDS UP TO 58 CM HIGH**

**LETTO RIALZATO CON SCALETTA ESTRAIBILE /
RAISED BED WITH PULL-OUT LADDER**

Reti e materassi / Mattress bases and mattresses

L / W 80, 90 cm
P / D 200 cm



**LETTO RIALZATO CON SCRITTOIO ESTRAIBILE E CON SCALETTA GRISÙ /
RAISED BED WITH PULL-OUT DESK AND GRISÙ LADDER**

Reti e materassi / Mattress bases and mattresses

L / W 80, 90 cm
P / D 200 cm



**LETTO RIALZATO CON SCALETTA 06 /
RAISED BED WITH 06 SIDE STEPS**

Disponibili anche con cassetto. /
Also come with the option of a drawer.



LETTI A CASTELLO / BUNK BEDS



I letti a castello sfruttano l'altezza della stanza, permettendo di disporre di spazio extra per inserire una seconda postazione letto, un angolo studio o gioco. Le protezioni laterali e le scalette assicurano sicurezza e praticità, rendendo questi letti una soluzione versatile per diverse esigenze.

Bunk beds make the most of the room's height, providing extra space to add a second bed, study nook or play area. The side guards and ladders ensure beds are safe and practical, making them a versatile solution for a host of different requirements.

LETTI A CASTELLO / BUNK BEDS

LETTO A CASTELLO CON FIANCO /
BUNK BED WITH SIDE PANEL



Disponibile anche con rete inclinabile con protezione L 161,5, 200 cm. / Also available with tipping mattress base with guard rail W 161,5, 200 cm.

RETI E MATERASSI /
MATTRESS BASES AND MATTRESSES

L / W 80, 90 cm
P / D 200 cm



LETTO A CASTELLO CON FIANCO ECCÌ /
BUNK BED WITH ECCÌ SIDE PANEL



Disponibile anche con rete inclinabile con protezione L 161,5, 200 cm. / Also available with tipping mattress base with guard rail W 161,5, 200 cm.

RETI E MATERASSI /
MATTRESS BASES AND MATTRESSES

L / W 80 cm
P / D 200 cm



FIANCHI DISPONIBILI /
SIDE PANEL OPTIONS



Il modello Lila non è combinabile per letto a castello con fianco Holly. /
The Lila model cannot be used in conjunction with bunk beds with Holly sides.

ACCESSORI /
ACCESSORIES

Per tutti i letti a castello sono disponibili le scalette 01, 02, 03, 04, 05, 08, 09, 15, le scalette Grisù e Flatty, le protezioni in pannello Nuk, Ergo e in metallo (disponibile con cuffia in tessuto) e Paddy imbottita. Scoprite da pag 118. / All bunk beds can be ordered with 01, 02, 03, 04, 05, 08, 09, 15 steps; Grisù and Flatty ladders; Nuk and Ergo panel guards, metal guard (available with fabric cover) and padded Paddy guard. See page 118 onwards to find out more.

* Scopri come attrezzare il letto inferiore a pag. 115 nella sezione accessori letto. / See how the bottom bunk can be fitted out on page 115 in the bed accessories section.

LETTO A CASTELLO CON FIANCO HOLLY /
BUNK BED WITH HOLLY SIDE



Disponibile anche con rete inclinabile con protezione L 161,5, 200 cm. / Also available with tipping mattress base with guard rail W 161,5, 200 cm.

RETI E MATERASSI /
MATTRESS BASES AND MATTRESSES

L / W 80, 90 cm
P / D 200 cm



LETTI A CASTELLO / BUNK BEDS

ARMADI SOTTOLETTO / UNDER-BED WARDROBES

ANTA ESTRAIBILE E SCRITTOIO /
PULL-OUT DOOR AND DESK



Guarda come sfruttare
l'anta estraibile. /
Watch how to make the most
of the pull-out door.

1 ANTA /
1 DOOR

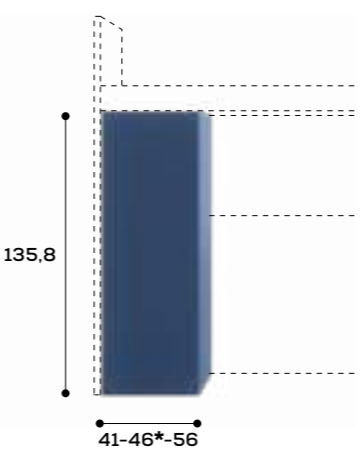

2 ANTE /
2 DOORS

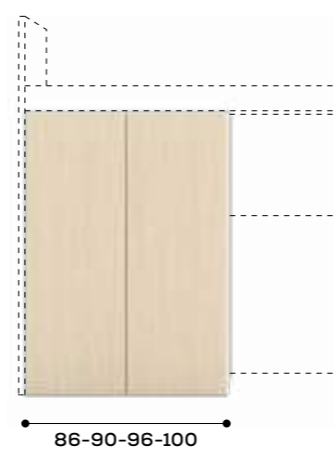

2 CASSETTI /
2 DRAWERS

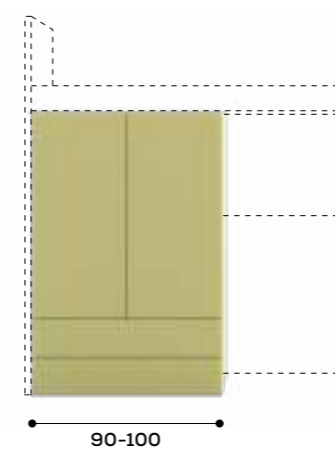

1 CASSETTONE /
1 OVERSIZED DRAWER

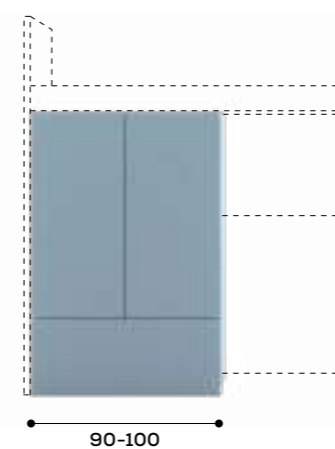

* Per la larghezza 46 cm è disponibile anche l'anta estraibile. /
The 46 cm width also comes with the pull-out door option.

COPPIA TENDE LOOP /
PAIR OF LOOP CURTAINS



Tende Loop disponibili in tessuto Griff. /
Loop curtains available in Griff fabric.

LIBRERIA /
BOOKCASE



LETTO A CASTELLO DOTS / DOTS BUNK BED

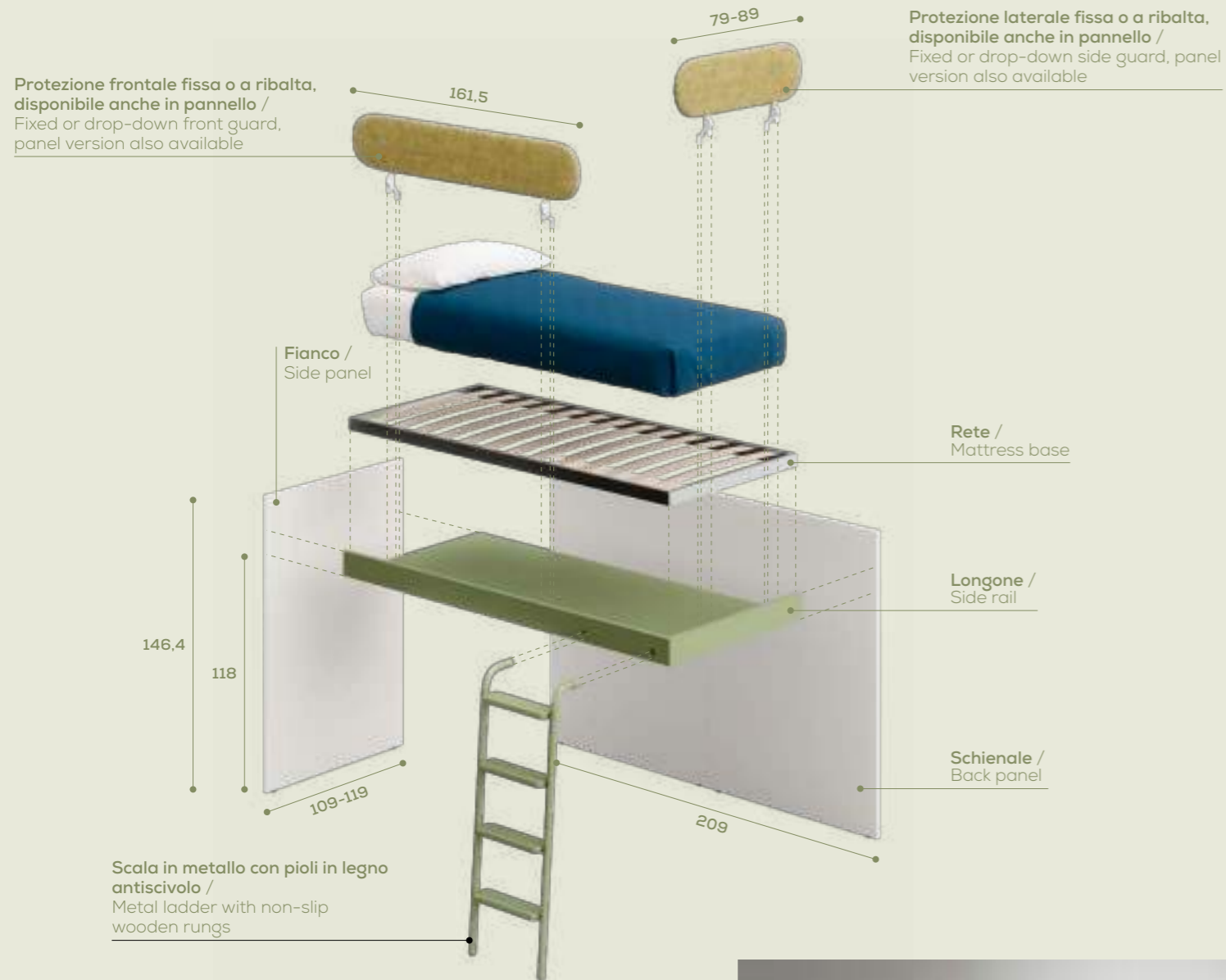

RETI E MATERASSI / MATTRESS BASES AND MATTRESSES

L / W 80, 90 cm
P / D 200 cm

La protezione fissa o a ribalta, frontale o laterale, è disponibile a pannello in tutte le finiture o imbottita in tutti i tessuti, entrambe con supporti in finitura nuvola. / The fixed or drop-down guard, whether on the front or side, comes in a panel version in all finishes or upholstered in all fabrics, both with supports in nuvola finish.



LETTI A CASTELLO / BUNK BEDS

LETTI A SBALZO / CANTILEVERED BEDS

RETI E MATERASSI /
MATTRESS BASES AND MATTRESSESL / W 80, 90 cm
P / D 200 cm

MODELLI DISPONIBILI / AVAILABLE MODELS

NUK

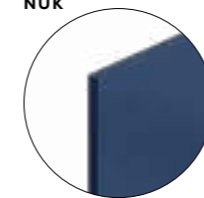

ERGO



Scopri le scalette Grisù e Flatty, le protezioni in pannello Nuk ed Ergo, in metallo (disponibile con cuffia in tessuto) e Paddy imbottita da pag. 118. / Find out more about the Grisù and Flatty ladders, Nuk and Ergo panel guards, metal guard (available with fabric cover) and padded Paddy guard from page 118 onwards.

LETTI A CASTELLO / BUNK BEDS

LETTO A CASTELLO SCORREVOLE SLOT /
SLOT SLIDING BUNK BED

RETI E MATERASSI /
MATTRESS BASES
AND MATTRESSES

L / W 80, 90 cm
P / D 200 cm



LETTO A CASTELLO SCORREVOLE SKID /
SKID SLIDING BUNK BED

RETI E MATERASSI /
MATTRESS BASES
AND MATTRESSES

L / W 90 cm
P / D 200 cm

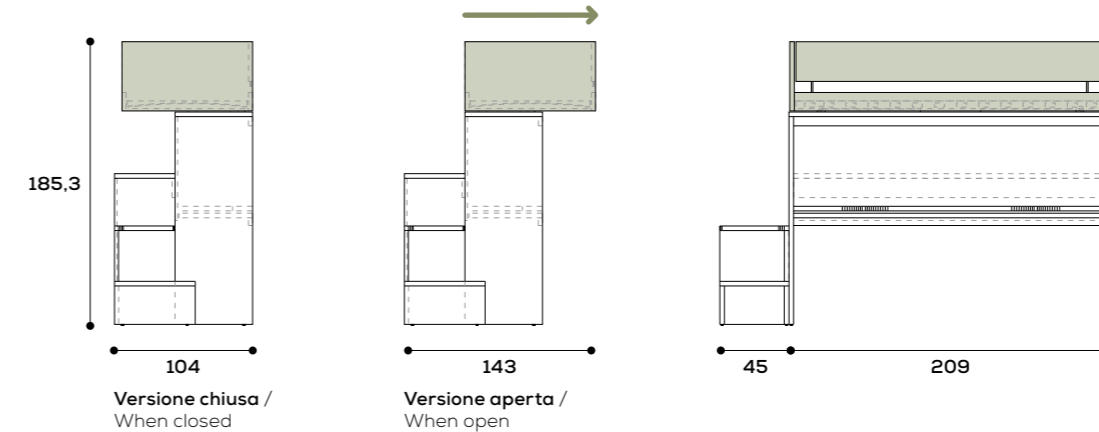
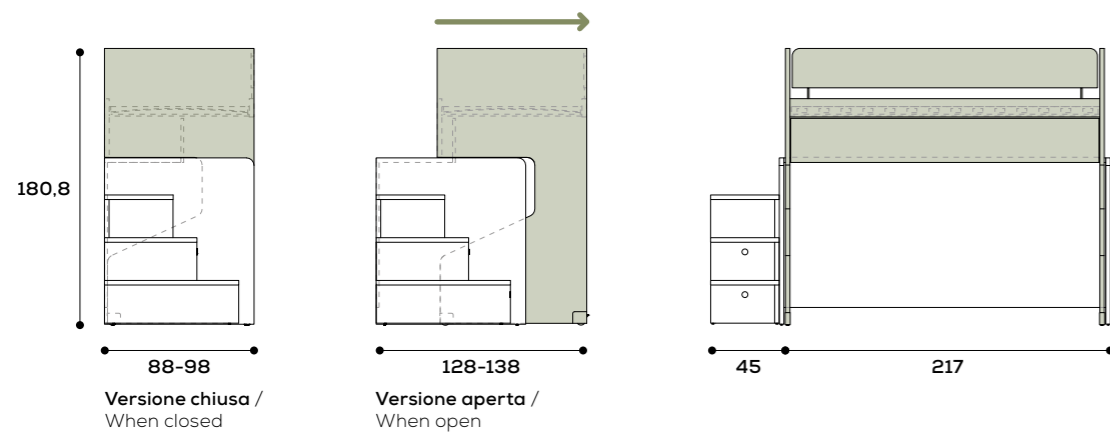

Il letto a castello scorrevole Skid è
disponibile anche senza scrittoio. /
The Skid sliding bunk bed also comes
with the option of no desk.

LETTI A CASTELLO / BUNK BEDS

LETTI CAMELOT /
CAMELOT BEDS

RETI E MATERASSI LETTI CAMELOT /
CAMELOT BED MATTRESS BASES AND MATTRESSES

Salita frontale / Access from front	Salita laterale / Access from side	Salita posteriore / Access from rear
L / W 80, 90, 120 cm	L / W 80, 90, 120 cm	L / W 80, 90 cm
P / D 200 cm	P / D 200 cm	P / D 200 cm



RETI E MATERASSI LETTI CAMELOT IMBOTTITI /
PADDED CAMELOT BED MATTRESS BASES AND MATTRESSES

Salita frontale / Access from front	Salita laterale / Access from side	Salita posteriore / Access from rear
L / W 90, 120 cm	L / W 90, 120 cm	L / W 80, 90 cm
P / D 200 cm	P / D 200 cm	P / D 200 cm



Letti Camelot disponibili in versione pannello o imbottiti.
Scopri le scalette Grisù e Flatty, le protezioni in pannello Nuk ed Ergo, in metallo (disponibile con cuffia in tessuto) e Paddy imbottita da pag. 118. /
Camelot beds available in panel or padded version.
Find out more about the Grisù and Flatty ladders, Nuk and Ergo panel guards, metal guard (available with fabric cover) and padded Paddy guard from page 118 onwards.

* Scopri come attrezzare il letto inferiore a pag. 115 nella sezione accessori letto. /
See how the bottom bunk can be fitted out on page 115 in the bed accessories section.

LETTI A CASTELLO / BUNK BEDS

LETTI CAMELOT /
CAMELOT BEDS



LETTI A SOPPALCO / LOFT BEDS



Elevando il letto, i soppalchi liberano lo spazio sottostante, permettendo di ricavare un'area multifunzionale, ideale per un secondo letto, una zona studio o una piccola libreria. Rispondono a diverse esigenze con soluzioni pratiche e personalizzabili, offrendo un'ottima gestione degli spazi.

By putting the bed on top, loft beds free up space underneath, leaving room for a multifunctional area, the ideal place for a second bed, a study nook or a small bookcase. They cater to a range of requirements with practical and customizable solutions, offering excellent space management.

LETTI A SOPPALCO / LOFT BEDS

SOPPALCHI LINEARI /
STRAIGHT LOFT BEDS

RETI E MATERASSI /
MATTRESS BASES AND MATTRESSES

L / W 80, 90 cm
P / D 200 cm



Disponibile anche con rete inclinabile con protezione L 161,5, 200 cm. / Also available with tipping mattress base with guard rail W 161,5, 200 cm.



PEDIERE /
FOOTBOARDS

NUK



88-98

ERGO



88-98

LILA



88-98

HOLLY



88-98

HOLLY SCRITTOIO
HOLLY DESK



88-98

Struttura disponibile in tutte le finiture. Scopri le scalette Grisù e Flatty, le protezioni in pannello Nuk ed Ergo, in metallo (disponibile con cuffia in tessuto) e Paddy imbottita da pag. 118. / Structure available in all finishes. Find out more about the Grisù and Flatty ladders, Nuk and Ergo panel guards, metal guard (available with fabric cover) and padded Paddy guard from page 118 onwards.

LETTI A SOPPALCO / LOFT BEDS

SOPPALCHI LINEARI /
STRAIGHT LOFT BEDS



LETTI A SOPPALCO / LOFT BEDS

SOPPALCHI AD ANGOLO /
CORNER LOFT BEDS

RETI E MATERASSI /
MATTRESS BASES AND MATTRESSES

L / W 80, 90 cm
P / D 200 cm

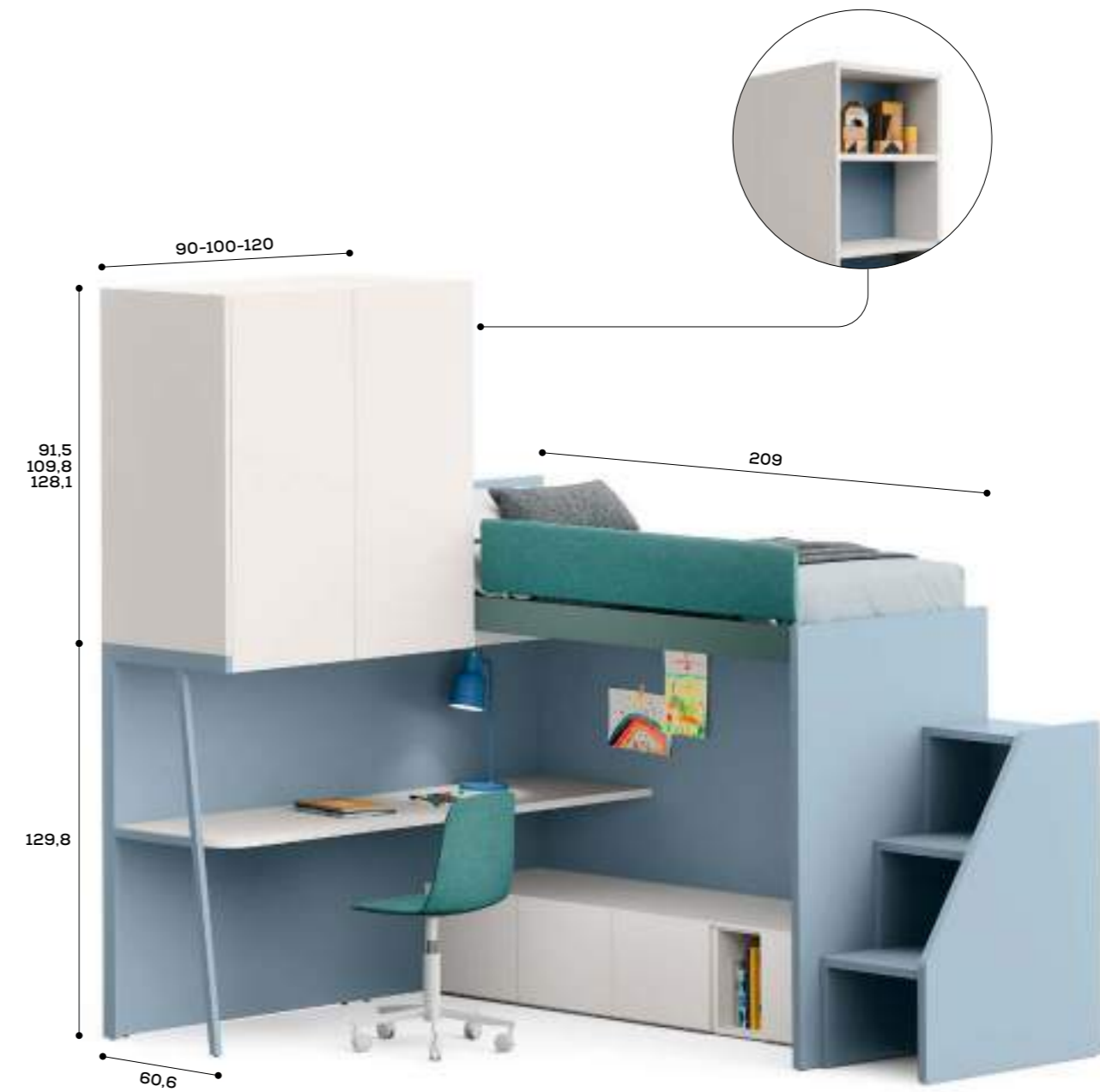

PEDIERE /
FOOTBOARDS

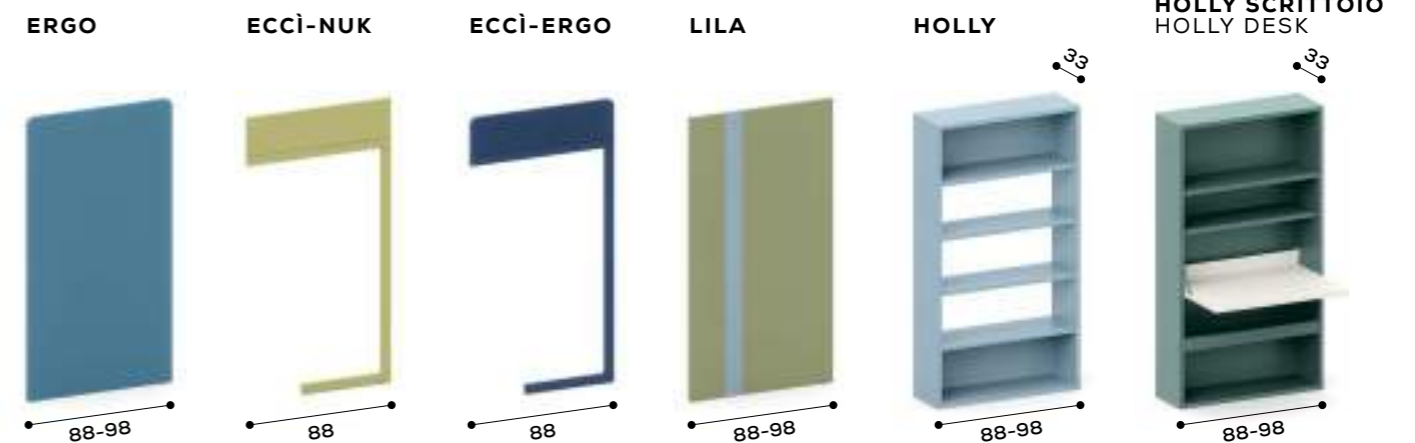

Scopri le scalette Grisù e Flatty, le protezioni in pannello Nuk ed Ergo, in metallo (disponibile con cuffia in tessuto) e Paddy imbottita da pag. 118. / Find out more about the Grisù and Flatty ladders, Nuk and Ergo panel guards, metal guard (available with fabric cover) and padded Paddy guard from page 118 onwards.

LETTI A SOPPALCO / LOFT BEDS

**SOPPALCHI LINEARI SCORREVOLI SKID /
SKID SLIDING STRAIGHT LOFT BEDS**

**RETI E MATERASSI /
MATTRESS BASES
AND MATTRESSES**

L / W 80, 90 cm
P / D 200 cm

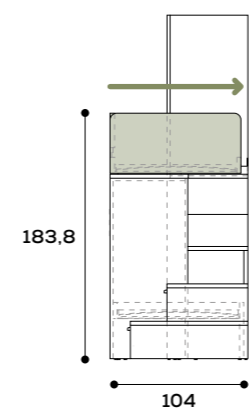
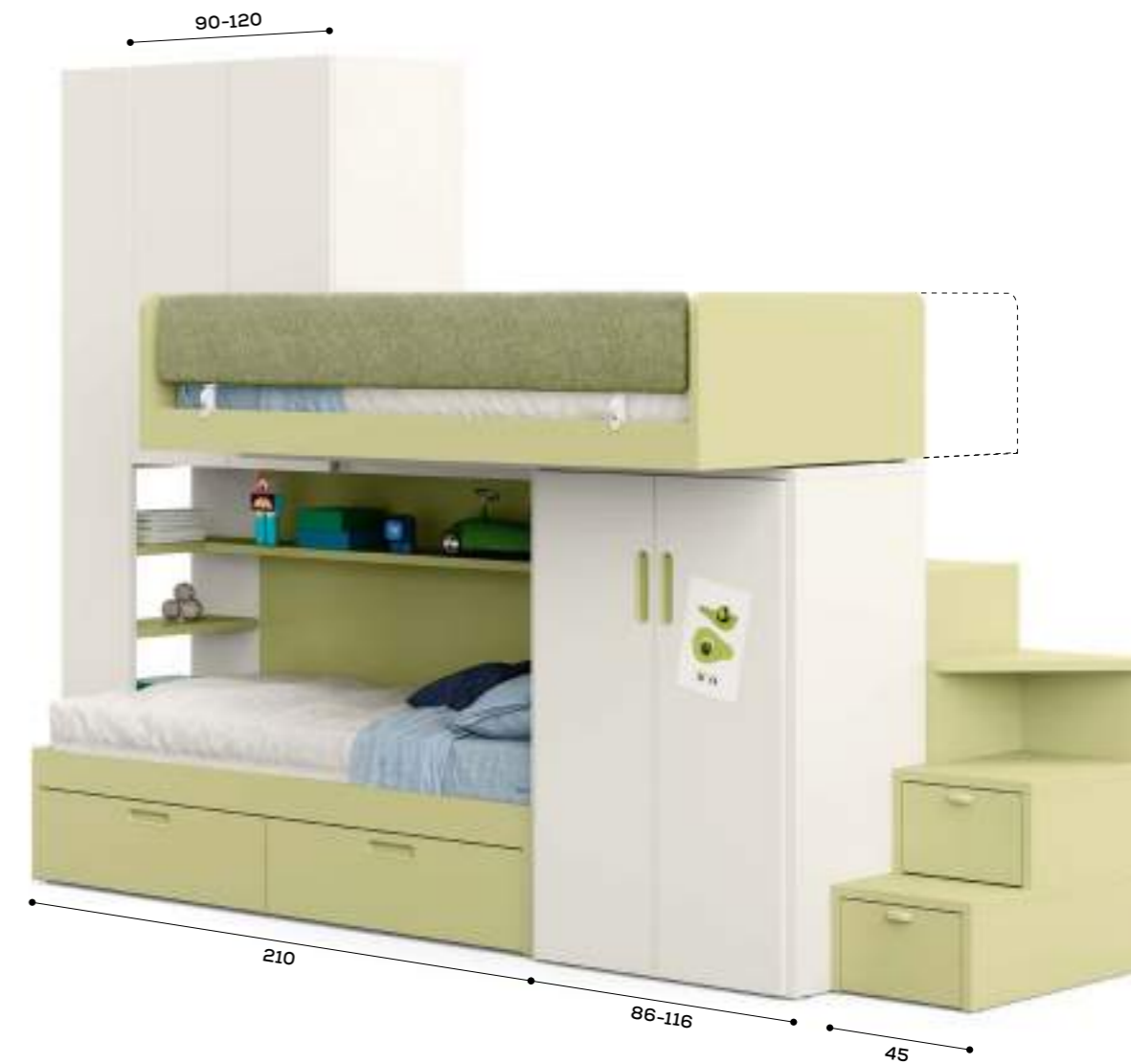

Versione chiusa /
When closed

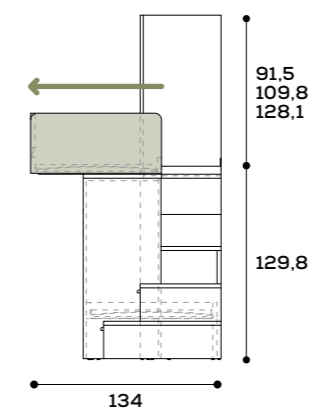

Versione aperta /
When open

Scopri le scalette Grisù e Flatty, le protezioni in pannello Nuk ed Ergo, in metallo (disponibile con cuffia in tessuto) e Paddy imbottita da pag. 118. / Find out more about the Grisù and Flatty ladders, Nuk and Ergo panel guards, metal guard (available with fabric cover) and padded Paddy guard from page 118 onwards.

LETTI A SOPPALCO / LOFT BEDS

**SOPPALCHI SCORREVOLI SLIDE /
SLIDE SLIDING LOFT BEDS**

RETI E MATERASSI /
MATTRESS BASES AND MATTRESSES

L / W 80, 90 cm
P / D 200 cm



Guarda come funziona il
meccanismo del soppalco
scorrevole Slide. /
Watch how the Slide
sliding loft bed
mechanism works.

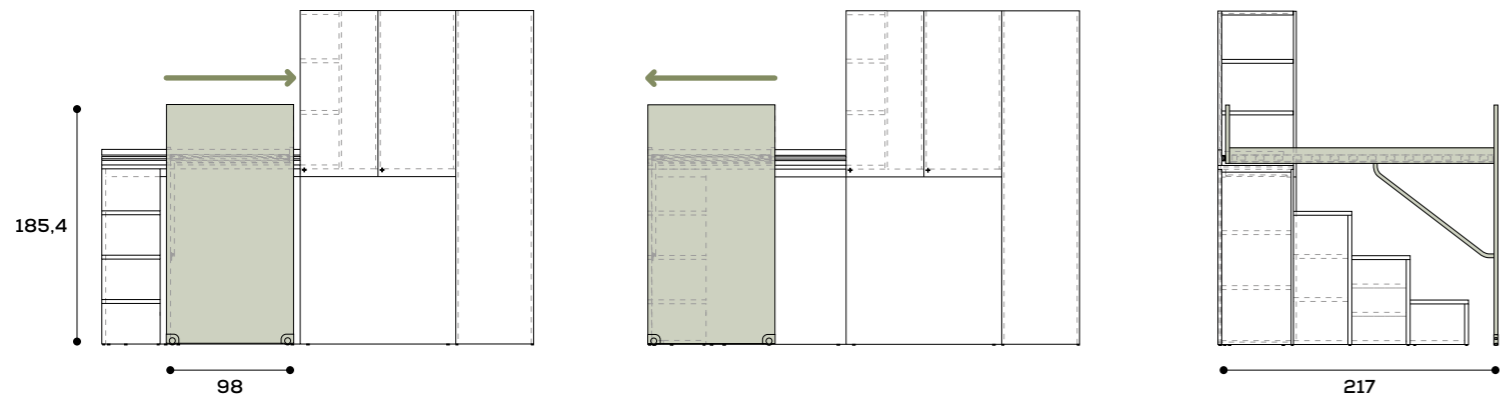

LETTO A BALDACCHINO KAP / KAP FOUR-POSTER BED



RETI E MATERASSI / MATTRESS BASES AND MATTRESSES

L / W 90, 120 cm
P / D 200 cm

Il letto a baldacchino Kap è una scelta romantica ma moderna che trasforma la camera in uno spazio intimo e accogliente. La struttura può essere completata da una tenda, mentre la testiera imbottita assicura il giusto comfort.

The Kap four-poster bed is a romantic yet modern choice that transforms the bedroom into an inviting, intimate space. The frame can be finished off with a curtain, while the padded headboard delivers the required comfort.

SISTEMA REGOLI / REGOLI SYSTEM



Il sistema Regoli consente di personalizzare la zona notte in modo creativo, grazie a cassetti e scomparti che ottimizzano lo spazio. La possibilità di aggiungere accessori come i fermamaterasso o le boccole di ventilazione rende le diverse composizioni ancora più funzionali.

The Regoli system allows you to put your personal creative stamp on the bedroom, with the aid of drawers and cubbyholes that optimize space. The option of adding accessories such as mattress retainers and vent grommets makes the resulting configurations even more functional.

SISTEMA REGOLI / REGOLI SYSTEM

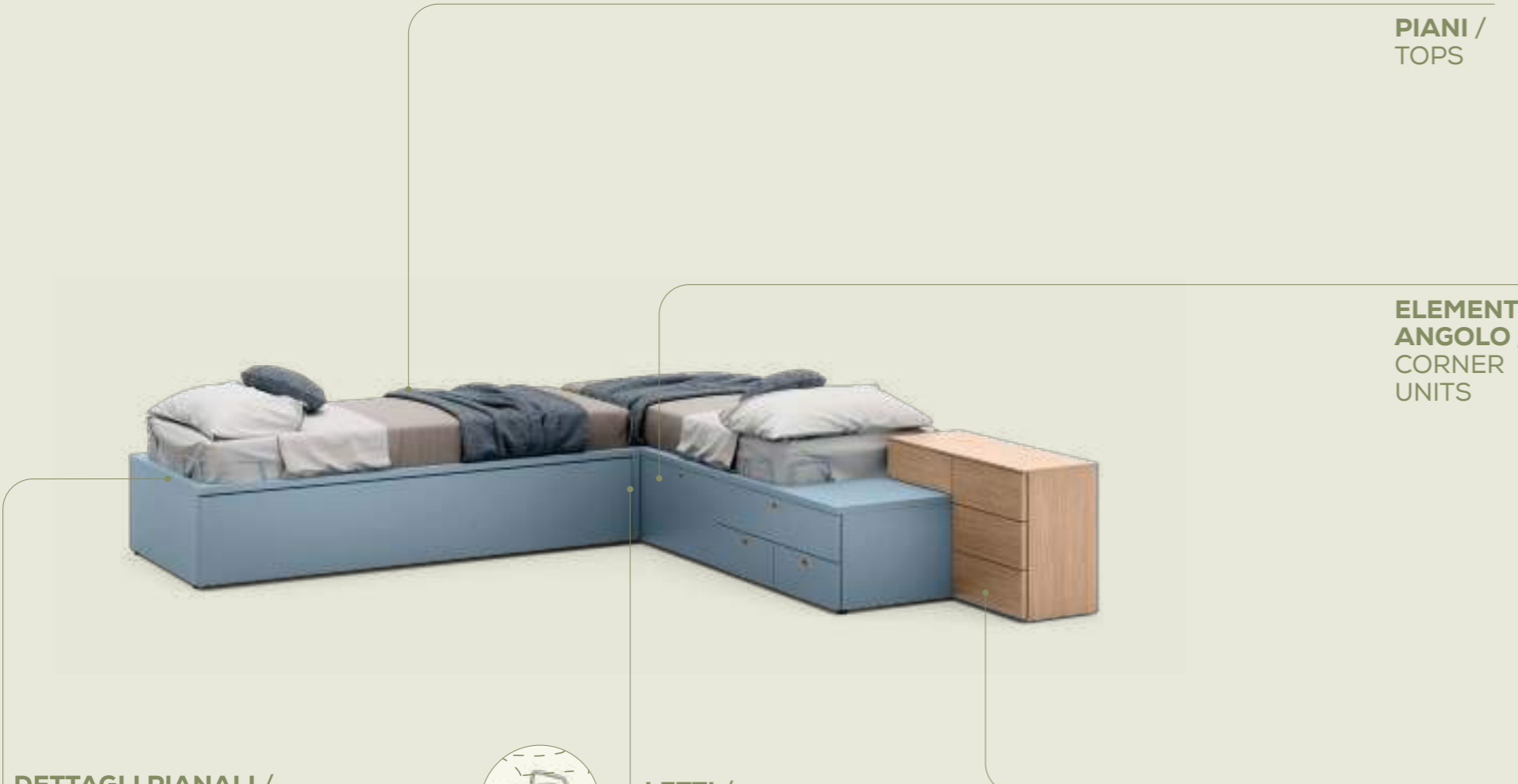

PIANI / TOPS

Top per moduli /
Tops for modules

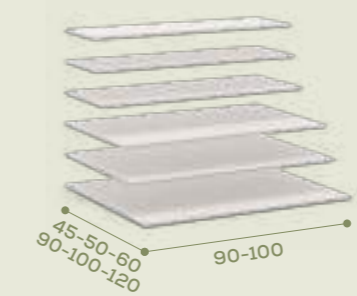

Top per pianali /
Top for solid
panel bases

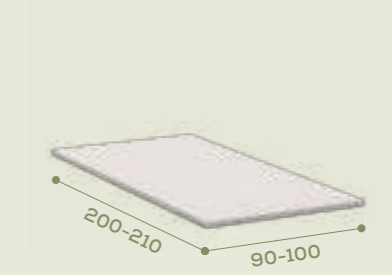

ELEMENTI ANGOLO / CORNER UNITS

Modulo ad
angolo /
Corner
module

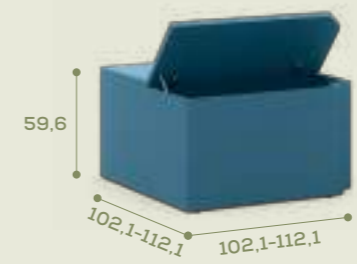

Elemento cieco
per angolo /
Blind unit
for corner



Tamponamento
per angolo /
Filler for
corner

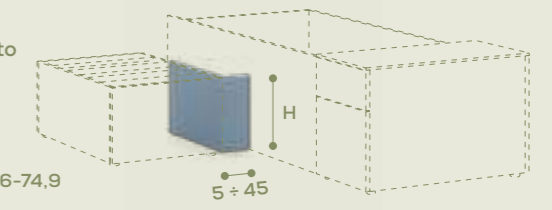

H: 20-38,3-56,6-74,9

DETTAGLI PIANALI / SOLID PANEL BASE DETAILS

Coppia
fermamaterasso /
Pair of mattress
retainers

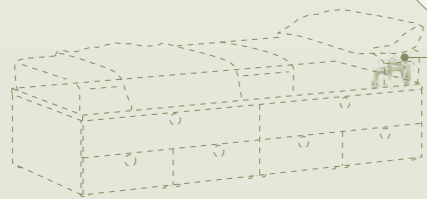

Pantografatura
per boccole
di areazione /
Shaped cut-outs
for vent grommets

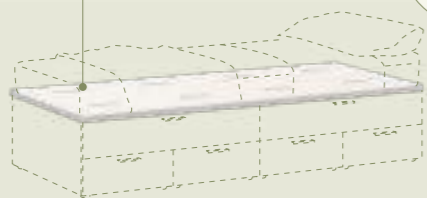

Telaio doghe
in appoggio /
Drop-in slat
frame

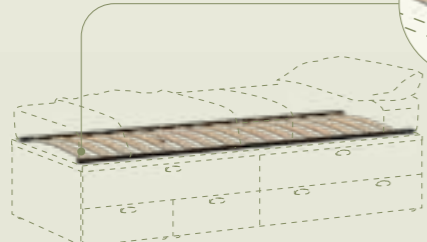

LETTI / BEDS

Letto a pianale /
Bed with solid
panel base



Reti e materassi /
Mattress bases and
mattresses
L / W 80, 90 cm
P / D 190, 200 cm

Letto a pianale
con rete estraibile /
Bed with solid panel
base and trundle



Reti e materassi /
Mattress bases and
mattresses
L / W 80, 90 cm
P / D 190, 200 cm

MODULI / MODULES

Moduli
a terra /
Floorstanding
modules

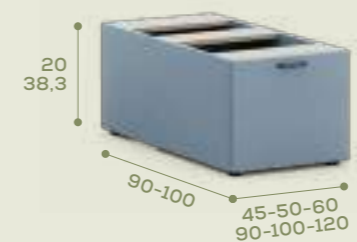

Moduli a terra
a giorno /
Floorstanding
open modules



Moduli
in appoggio /
Sit-on-top
modules

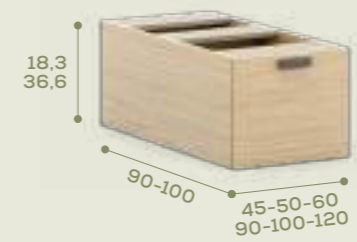

Moduli in
appoggio a
giorno /
Sit-on-top
open modules

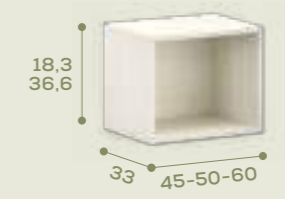

Contenitore
base Regoli /
Regoli base
storage unit



SISTEMA REGOLI / REGOLI SYSTEM

Regoli è un sistema di moduli sovrapponibili e combinabili tra loro che permette di organizzare lo spazio in modo innovativo e divertente. Un gioco d'arredi che anima e dà vita ad ogni stanza.

Regoli is a system of modules that can be stacked and combined, allowing you to organize the space in a fun and innovative way. A series of furniture building blocks that inject cheerfulness, bringing any room to life.

Regoli si integra a tutte le basi contenitore. /
Regoli can be integrated with all base storage units.

Il modulo ad angolo contenitore offre la possibilità di creare infinite soluzioni su misura per le proprie esigenze. /
The corner storage module allows you to create endless solutions tailored to your requirements.

I moduli Regoli permettono l'apertura su più lati, offrendo una maggiore flessibilità progettuale nella disposizione degli elementi. /
Regoli modules are designed to be opened from multiple sides, giving you greater design flexibility when it comes to arranging the units.

Il sistema Regoli consente di combinare tra loro moduli a terra, in appoggio e chiusi o a giorno per creare delle soluzioni letto inedite. /
With the Regoli system, floorstanding, sit-on-top and closed and open modules can be mixed and matched to create new bed solutions every time.

Il letto a pianale con rete estraibile, attrezzabile con materasso, raddoppia il comfort. /
The bed with solid panel base and trundle, which can be fitted with a mattress, offers double the comfort.

Il cassetto interno dispone di guide rallentate ad estrazione totale. /
The built-in drawer features full-extension soft-close runners.

Il top pianale è disponibile anche con fermamaterasso, boccole per l'aerazione del materasso o telaio a doghe in appoggio. /
The solid panel top is also available with mattress retainers, mattress vent grommets or drop-in slat frame.

Fare riferimento al listino per verificare eventuali limitazioni. /
Refer to the price list to check for any limitations.



SISTEMA REGOLI / REGOLI SYSTEM

Boiserie Becky /
Becky wall panelling

Coppia fermamaterasso /
Pair of mattress retainers

Top per basi /
Top for base units

Contenitore base a terra /
Floorstanding base storage unit

Top per pianale /
Top for solid panel base

Modulo a terra /
Floorstanding module



Top per modulo /
Top for module

Contenitore base a terra /
Floorstanding base storage unit

Pantografatura per boccole di aerazione /
Shaped cut-outs for vent grommets

Modulo a terra /
Floorstanding module



Guarda la componibilità
del sistema Regoli. /
Watch how the Regoli system
can be put together.

SISTEMA REGOLI / REGOLI SYSTEM



SISTEMA REGOLI / REGOLI SYSTEM



SISTEMA REGOLI / REGOLI SYSTEM



LETTI A RIBALTA TWIDDY / TWIDDY DROP-DOWN BEDS



Guarda i meccanismi di
apertura del letto Twiddy. /
Watch how the Twiddy bed
opening mechanisms work.



I letti a ribalta Twiddy sono la soluzione perfetta per chi ha bisogno di un letto senza sacrificare spazio. Facili da aprire e richiudere grazie a un meccanismo con pistone ammortizzato, offrono praticità e comfort, integrandosi armoniosamente nell'arredamento, grazie alla struttura compatta e discreta.

Twiddy drop-down beds are the perfect solution if you need a bed but don't want to sacrifice space. Easy to open out and fold away thanks to a soft-closing gas lift system, they offer practicality and comfort, while their discreet, compact structure allows them to blend harmoniously with the decor.

LETTI A RIBALTA TWIDDY / TWIDDY DROP-DOWN BEDS

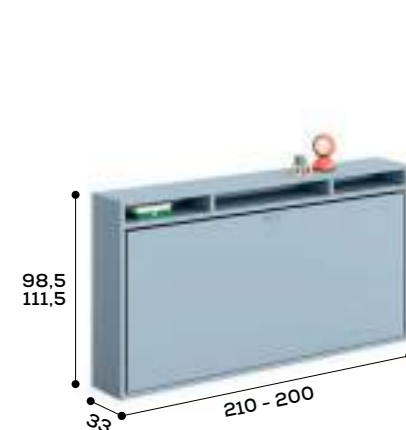
LETTI A RIBALTA TWIDDY 01 /
TWIDDY 01 DROP-DOWN BEDSRETI E MATERASSI /
MATTRESS BASES AND MATTRESSESL / W 80, 120 cm
P / D 190 cmLETTI A RIBALTA TWIDDY 03A /
TWIDDY 03A DROP-DOWN BEDSRETI E MATERASSI /
MATTRESS BASES AND MATTRESSESL / W 80 cm
P / D 190 cmLETTI A RIBALTA TWIDDY 03C /
TWIDDY 03C DROP-DOWN BEDSRETI E MATERASSI /
MATTRESS BASES AND MATTRESSESL / W 80 cm
P / D 190 cmLETTI A RIBALTA TWIDDY 02 /
TWIDDY 02 DROP-DOWN BEDSRETI E MATERASSI /
MATTRESS BASES AND MATTRESSESL / W 80 cm L / W 90 cm*
P / D 190 cm P / D 190, 200 cm* Larghezza rete e materasso 90 cm disponibile solo per H 111.5 cm. /
90 cm mattress base and mattress width available for 111.5 cm height only.LETTI A RIBALTA TWIDDY 03B /
TWIDDY 03B DROP-DOWN BEDSRETI E MATERASSI /
MATTRESS BASES AND MATTRESSESL / W 80 cm
P / D 190 cmTutte le versioni dei letti a ribalta Twiddy sono disponibili con rete ortopedica
ribaltabile con meccanismo a pistone ammortizzato ed apertura automatica
gambe. / All Twiddy drop-down bed versions are available with a fold-down
orthopaedic mattress base with soft-closing gas lift system and legs folding
out automatically.



ACCESSORI LETTO BED ACCESSORIES

Gli accessori per il letto, come le reti con sollevamento manuale o a pistone, i cassetti estraibili e i contenitori integrati, ottimizzano l'uso dello spazio disponibile. Contenitori retroletto, protezioni e altri elementi aggiuntivi offrono la possibilità di personalizzare il letto, adattandolo perfettamente alle proprie esigenze di comfort e praticità.

Bed accessories – like mattress bases with a manual or piston lift system, pull-out drawers and built-in storage units – optimize use of the available space. Rear-bed storage units, guards and other additional elements provide plenty of options for customizing the bed, tailoring it to perfectly suit your requirements in terms of comfort and practicality.

02 ACCESSORI LETTO / BED ACCESSORIES



114 Reti e cassetti estraibili /
Pull-out mattress bases and drawers



116 Elementi retroletto /
Rear-bed storage units



118 Protezioni per letti /
Bed guards



122 Elementi di salita /
Ladders and steps

START!





RETI E CASSETTI ESTRAIBILI / PULL-OUT MATTRESS BASES AND DRAWERS

**CASSETTONI ESTRAIBILI /
PULL-OUT OVERSIZED DRAWERS**

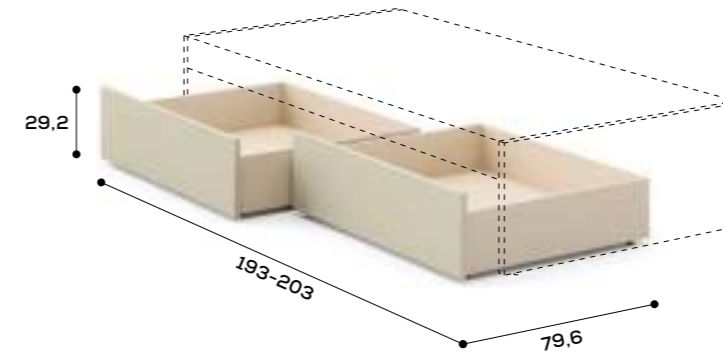

**COPPIA BASI FISSE CON CASSETTONI ESTRAIBILI P 75 /
PAIR OF FIXED BASE UNITS WITH PULL-OUT OVERSIZED
DRAWERS D 75**

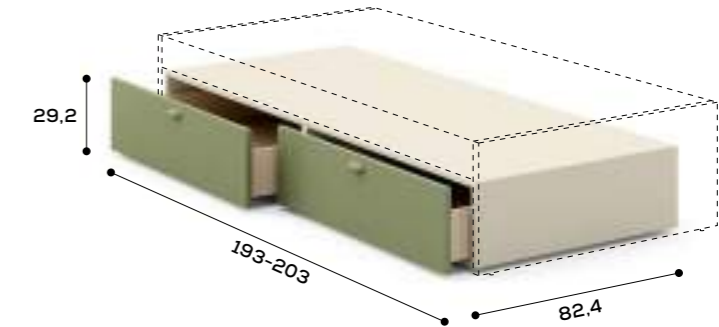

Struttura in finitura nuvola. Non disponibile maniglia In e OI e con rallentatore di chiusura. / Structure in nuvola finish. In and OI handles and soft-close device not an option.

**LIBRERIA A GIORNO IN FOLDING /
MITRE-FOLDED OPEN BOOKCASE**

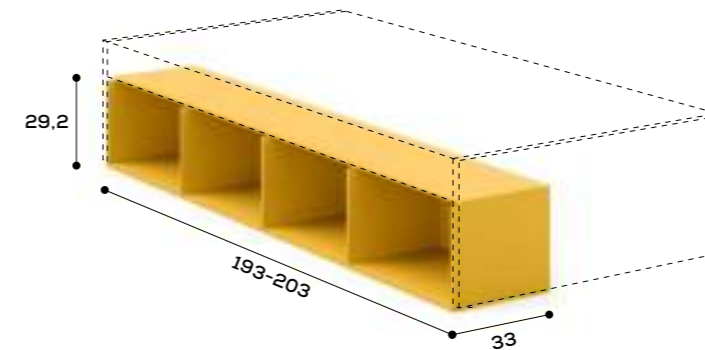

Non posizionabile sotto ai letti con gambe, letti attrezzati e letti con ruote. / Cannot be placed under beds on legs, equipped beds or beds on wheels.

**RETE ESTRAIBILE /
PULL-OUT MATTRESS BASE**

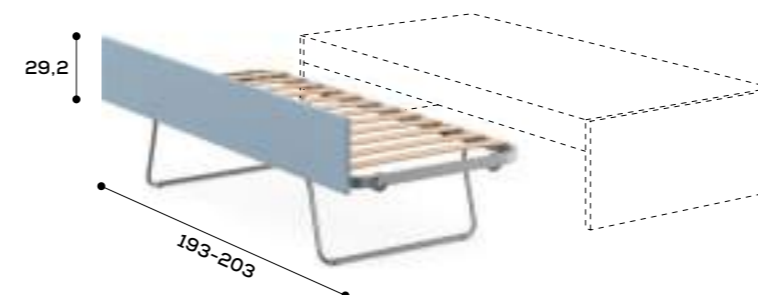

Dotata di gambe di sollevamento ad apertura manuale. Utilizzando materassi H 16 cm si allinea al letto. Disponibile anche in versione imbottita. / Features raising legs that fold out manually. Using 16cm-high mattresses, both beds lie flush. Also comes in upholstered version.

**RETE ESTRAIBILE LUX /
LUX PULL-OUT MATTRESS BASE**

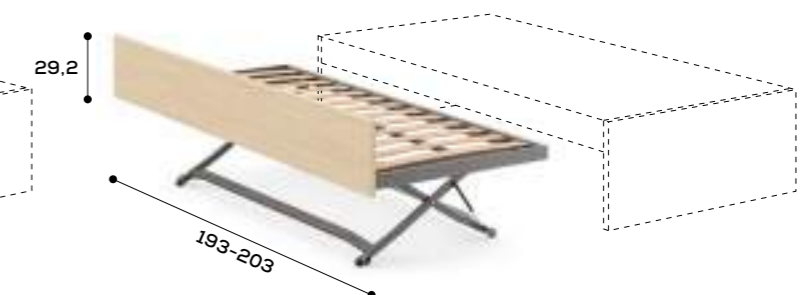

Dotata di meccanismo di sollevamento con pistoni a gas. Utilizzando materassi H 16 cm si allinea al letto. Disponibile anche in versione imbottita. / Features gas lift mechanism. Using 16cm-high mattresses, both beds lie flush. Also comes in upholstered version.



Guarda il meccanismo di sollevamento della rete estraibile Lux. / Watch how the Lux pull-out mattress base mechanism works.

ELEMENTI RETROLETTO / REAR-BED STORAGE UNITS

**ELEMENTO RETROLETTO CON CASSETTONE /
REAR-BED STORAGE UNIT WITH OVERSIZED DRAWER**

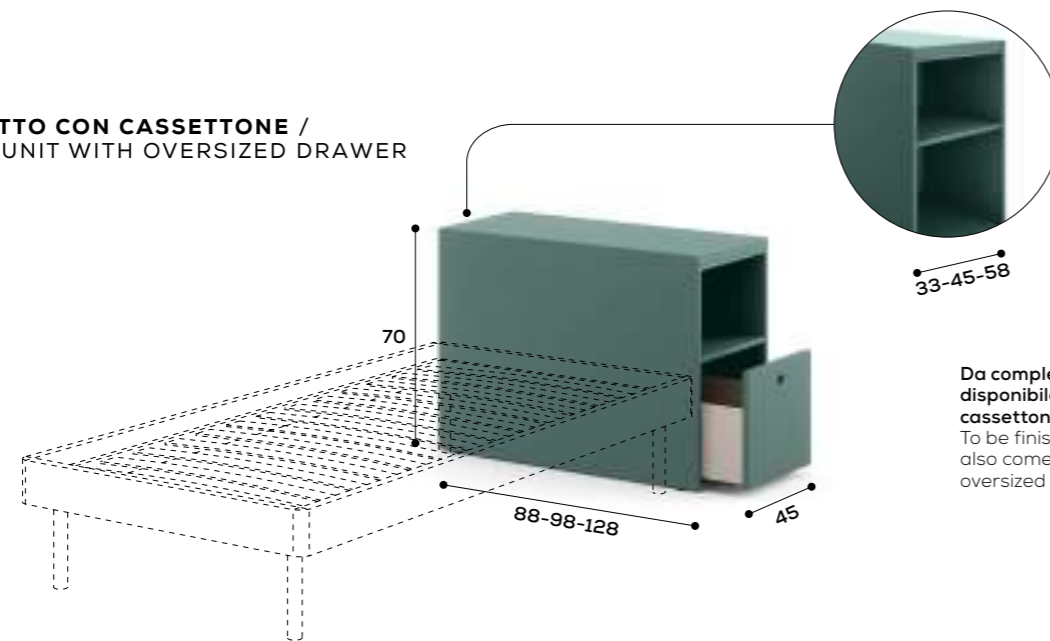

Da completare con top e
disponibile anche senza
cassettone. /
To be finished off with top;
also comes without the
oversized drawer.

**ELEMENTO RETROLETTO CON LIBRERIA ESTRAIBILE /
REAR-BED STORAGE UNIT WITH PULL-OUT BOOKCASE**

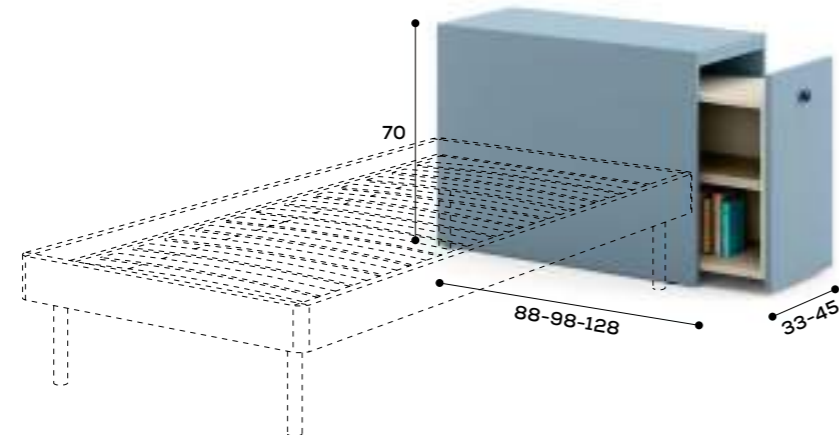

Da completare con top. /
To be finished off with top.

**ELEMENTO RETROLETTO CON RIBALTA SUPERIORE /
REAR-BED STORAGE UNIT WITH LIFT-UP TOP**

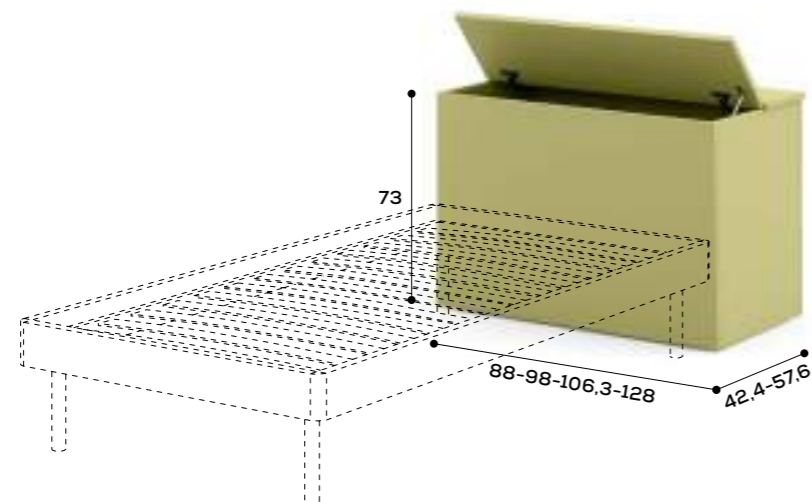

Disponibili tutte le maniglie
per cassetto, tranne
Push-Pull. /
Can be paired with all
drawer handles except
push-to-open model.



PROTEZIONI PER LETTI / BED GUARDS

PROTEZIONI METALLICHE / METAL GUARD RAILS

PROTEZIONE IN METALLO L 100 CM SOTTO MATERASSO /
METAL GUARD RAIL 100 CM WIDE UNDER MATTRESS

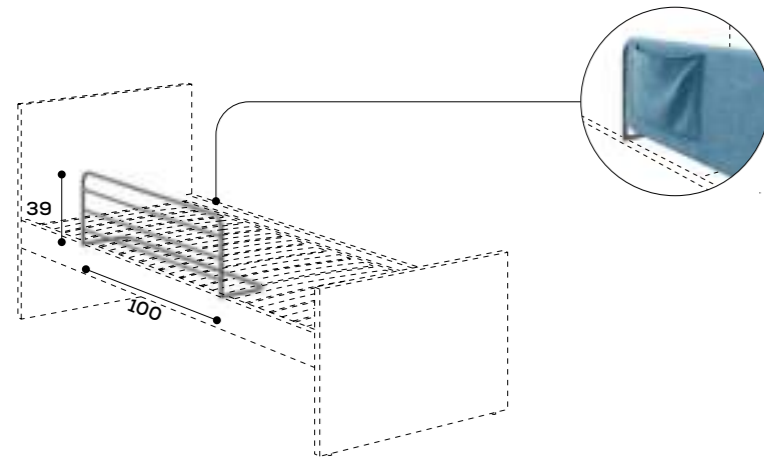

Utilizzo sotto materasso senza sistemi di fissaggio.
Disponibile con cuffia in tessuto con tasca. / Used under mattress
without fastening systems. Available with fabric cover with pocket.

PROTEZIONE IN METALLO A RIBALTA L 157,7-200 CM /
METAL DROP-DOWN GUARD 157,7-200 CM WIDE

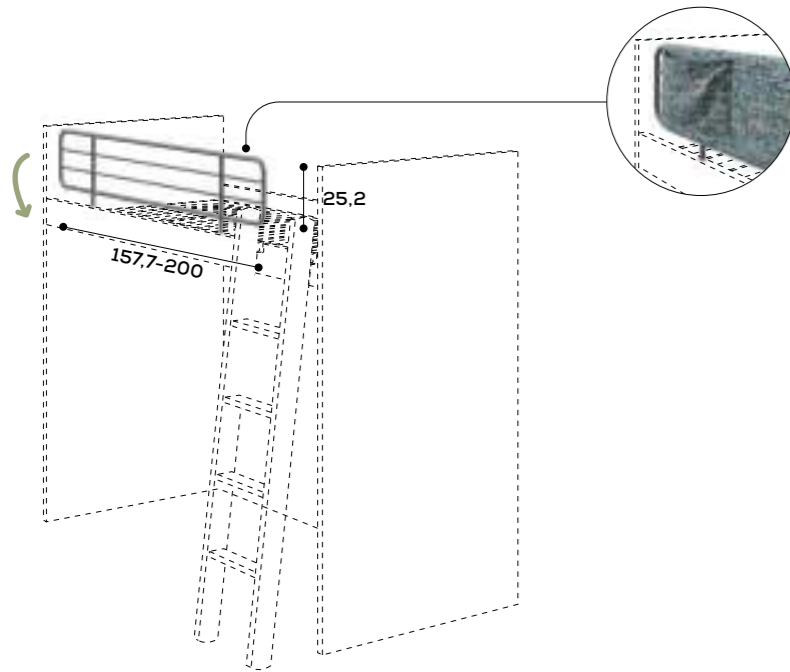

Disponibile con cuffia in tessuto. /
Available with fabric cover.

PROTEZIONE FISSA PER PIEDIERA /
FIXED METAL FOOTBOARD GUARD

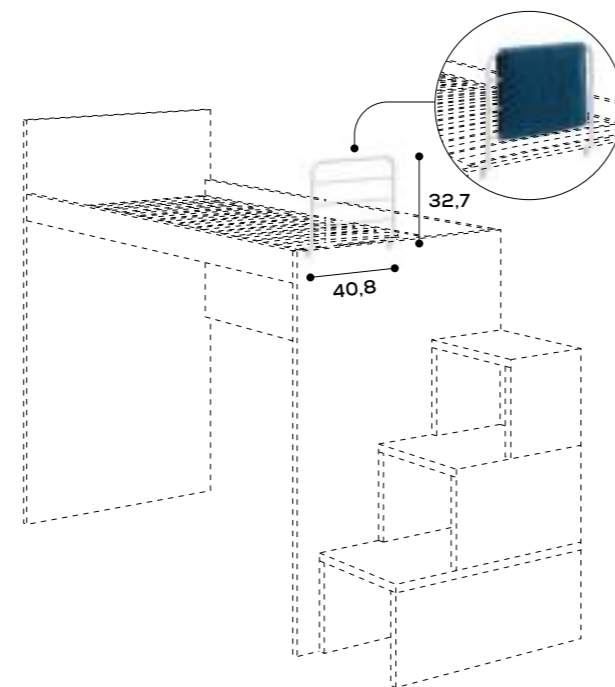

Disponibile con cuffia in tessuto. /
Available with fabric cover.



PROTEZIONI PER LETTI / BED GUARDS

PROTEZIONI PER CASTELLI E SOPPALCHI /
GUARDS FOR BUNK AND LOFT BEDS

PROTEZIONE L 161,5 CM /
GUARD 161,5 CM WIDE

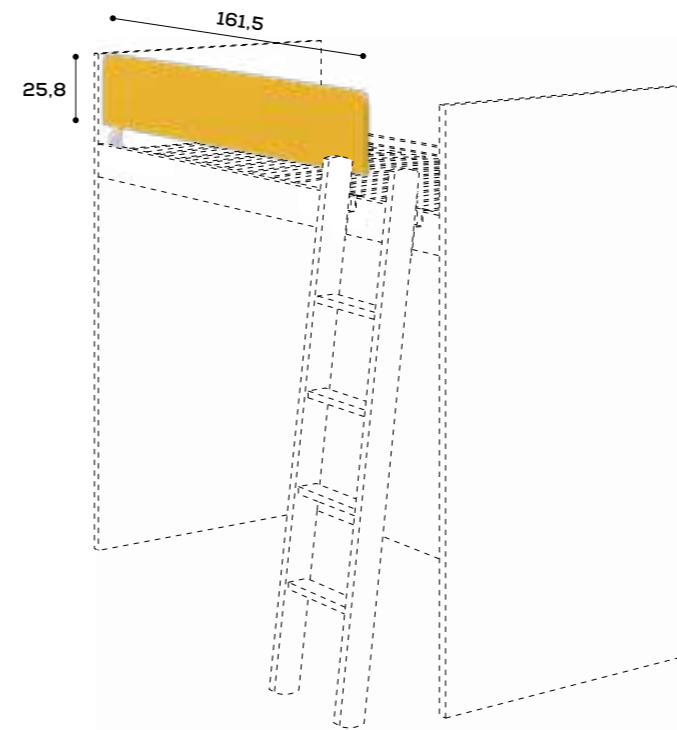

PROTEZIONE L 200 CM /
GUARD 200 CM WIDE

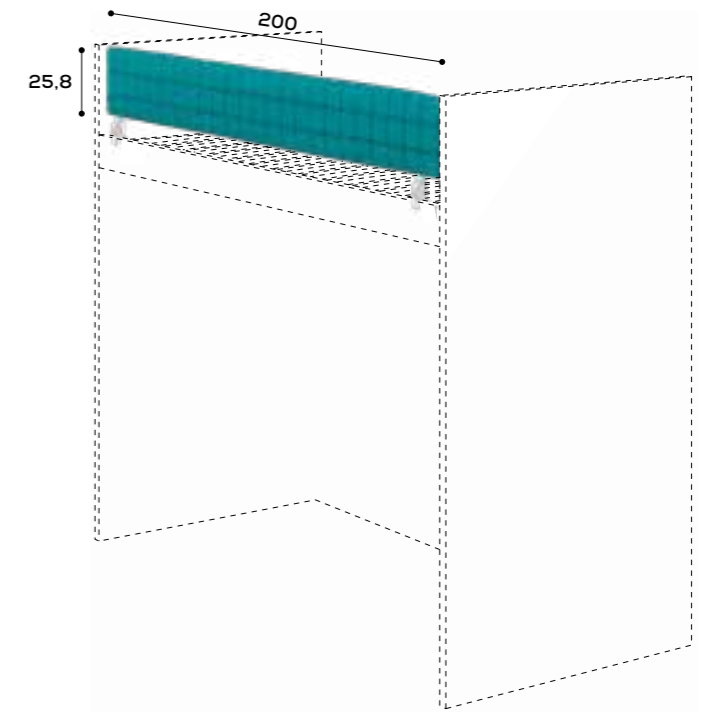

MODELLI DISPONIBILI / AVAILABLE MODELS

NUK

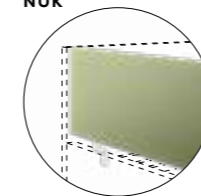

Spessore 1,8 cm /
1,8 cm thick

ERGO

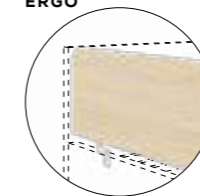

Spessore 1,8 cm /
1,8 cm thick

PADDY

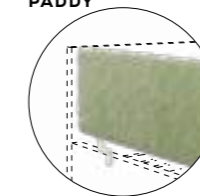

Spessore 3 cm /
3 cm thick

Disponibili in versione fissa o a ribalta. /
Come in fixed or drop-down version.

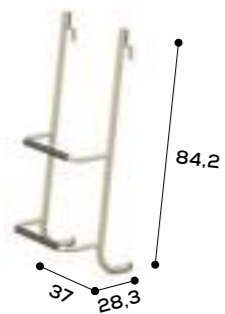

ELEMENTI DI SALITA / LADDERS AND STEPS

SCALETTE A PIOLI /
LADDERSGRISÙ PER SALITA LATERALE /
GRISÙ FOR ACCESS FROM SIDE

Disponibile solo per letti rialzati H 119 cm. /
Only available for raised beds H 119 cm.

GRISÙ

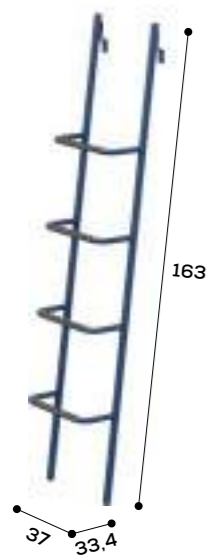

Per tutti i letti a castello, soppalchi con salita frontale, per letto Camelot anche laterale. / For all bunk beds, loft beds with access from the front; can also be used for side access for Camelot bed.

FLATTY



Per tutti i letti a castello, soppalchi con salita frontale, per letto Camelot anche laterale. / For all bunk beds, loft beds with access from the front; can also be used for side access for Camelot bed.



ELEMENTI DI SALITA / LADDERS AND STEPS

SCALETTA POSTERIORE PER CASTELLI E SOPPALCHI / REAR STEPS FOR BUNK AND LOFT BEDS

H 108,7 CM

Scaletta 01 / 01 steps

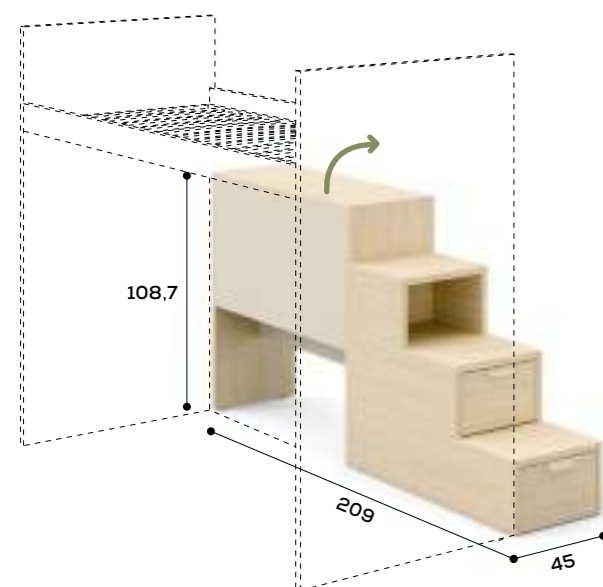

Disponibili con cassetti su guide rallentate o con vani a giorno. / Come with soft-close drawers or with open shelving.

Scaletta 02 / 02 steps

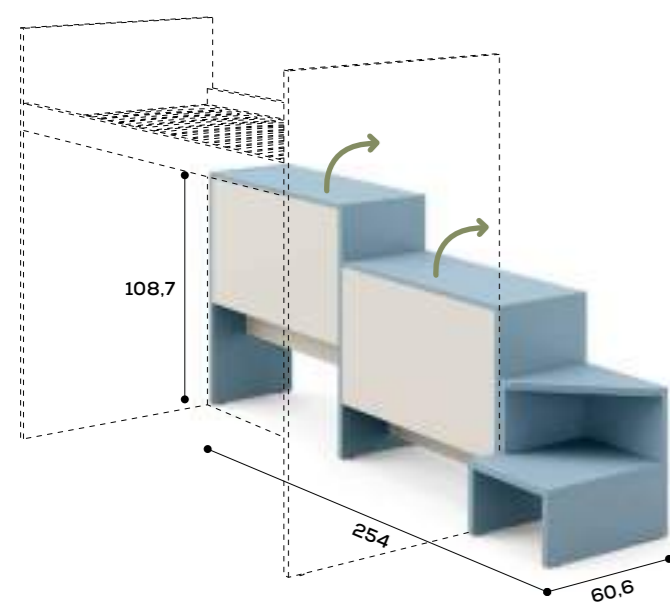

Disponibili con cassetti su guide rallentate o con vani a giorno. / Come with soft-close drawers or with open shelving.

Scaletta 03 / 03 steps

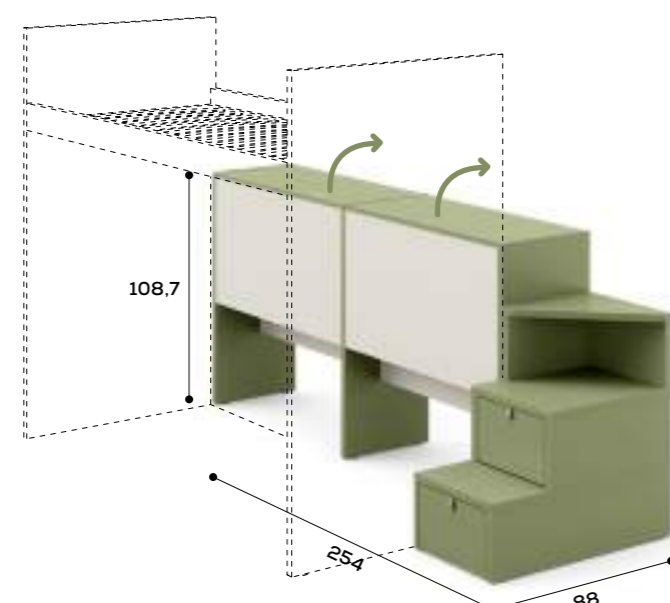

Disponibili con cassetti su guide rallentate o con vani a giorno. / Come with soft-close drawers or with open shelving.

H 98,7 CM

Scaletta 08 con vani a giorno / 08 steps with open shelving

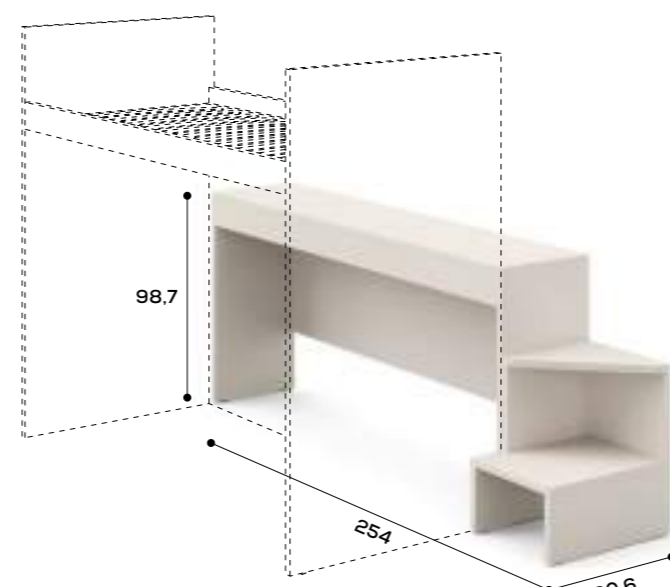

Disponibili con cassetti su guide rallentate o con vani a giorno. / Come with soft-close drawers or with open shelving.

Scaletta 09 con libreria / 09 steps with bookcase

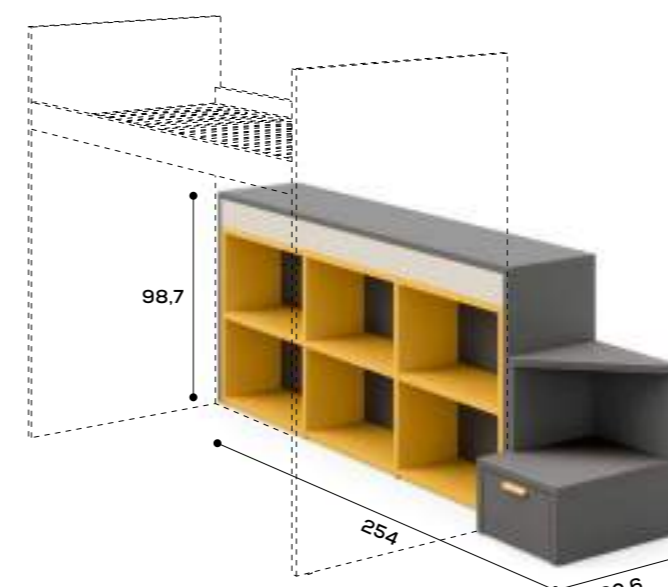

Disponibili con cassetti su guide rallentate o con vani a giorno. / Come with soft-close drawers or with open shelving.



ELEMENTI DI SALITA LATERALE / SIDE STEPS

H 56 CM

Scaletta 06 / 06 steps

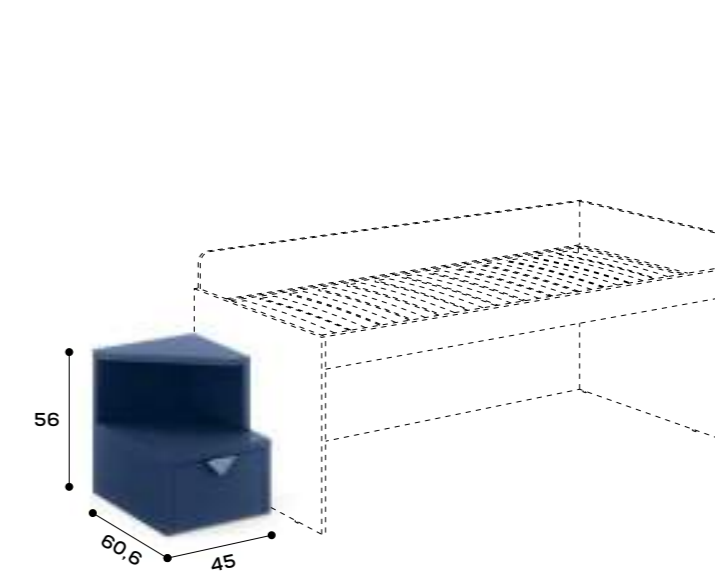

Da utilizzare con letti rialzati H 119 cm con salita laterale. Disponibili con cassetti su guide rallentate o con vani a giorno. / For use with raised beds H 119 cm with access from side. Come with soft-close drawers or with open shelving.

H 84,7 CM

Scaletta 07 / 07 steps

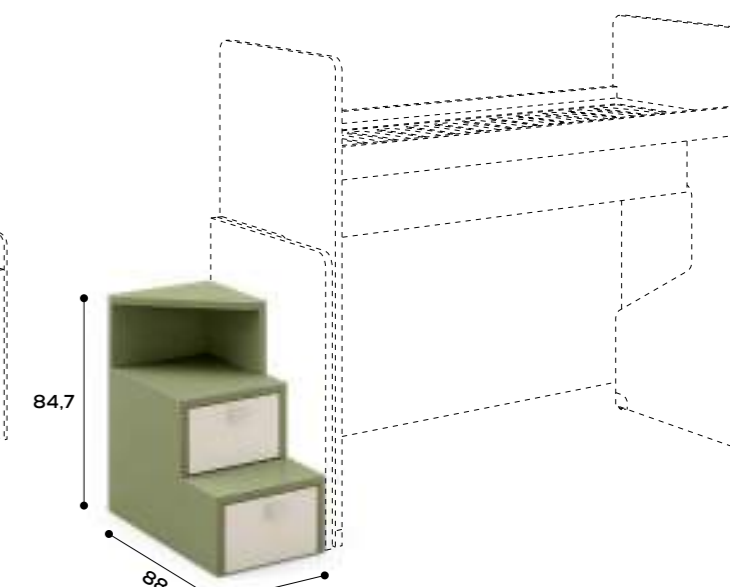

Da utilizzare con letti a castello scorrevole Slot. Disponibili con cassetti su guide rallentate o con vani a giorno. / For use with Slot sliding bunk beds. Come with soft-close drawers or with open shelving.

H 108,7 CM

Scaletta 05 / 05 steps

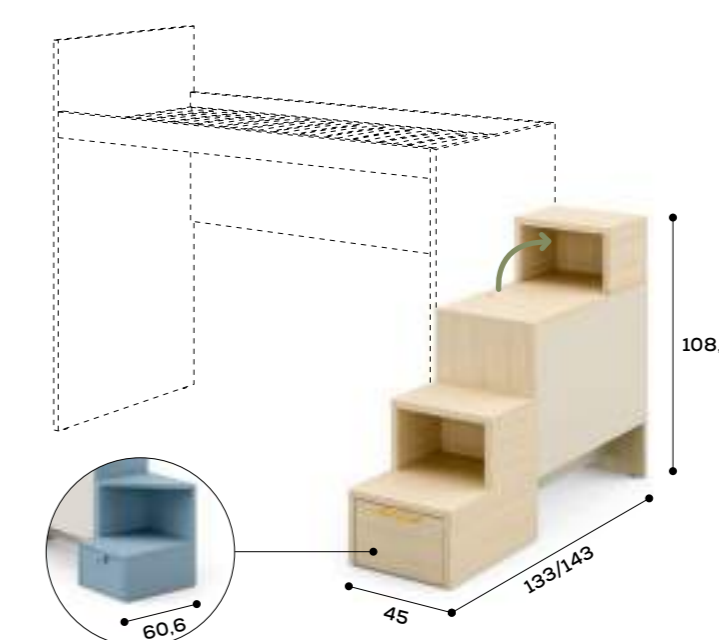

Disponibili con cassetti su guide rallentate o con vani a giorno. / Come with soft-close drawers or with open shelving.

Scaletta 04 / 04 steps

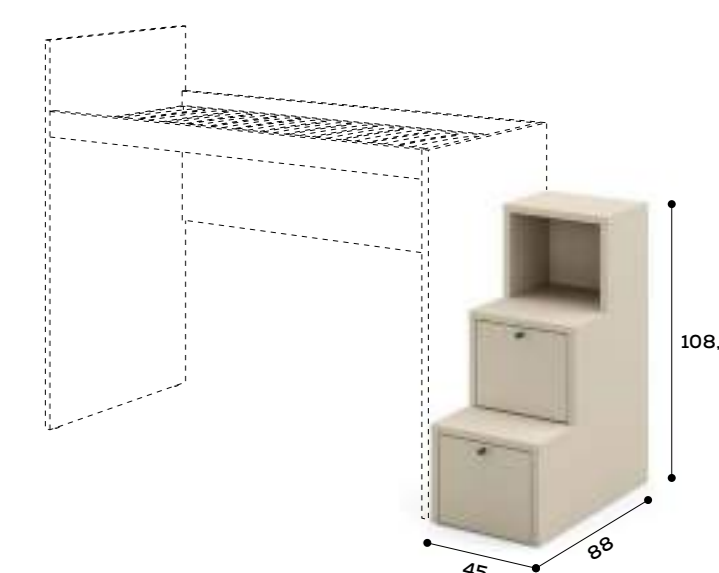

Da utilizzare con fianchi filo longone per salita laterale di letti a castello, soppalchi; riducibile in larghezza. Disponibili con cassetti su guide rallentate o con vani a giorno. / For use with side panels flush with side rail for access from side on bunk beds and loft beds; reduction possible in width. Come with soft-close drawers or with open shelving.



COMODINI BEDSIDE TABLES

I comodini completano la zona letto, offrendo al contempo praticità e personalizzazione. Disponibili in diversi modelli, offrono varie opzioni di contenimento, dai cassetti ai vani a giorno. Con diverse finiture e colori, si abbinano perfettamente al letto, creando un ambiente coordinato e funzionale.

Bedside tables add the finishing touch to the bedroom, offering both practicality and a chance to put your personal stamp on the room. Available in various models, they offer a range of storage options, from drawers to open shelving. With various finishes and colour options, they go perfectly with the bed, creating a coordinated and functional room.

03 COMODINI / BEDSIDE TABLES



130 Comodini P 45,4 /
Bedside tables D 45,4



134 Elemento Jack /
Jack unit



136 Comodini Wilson /
Wilson bedside tables



138 Comodini Luce /
Luce bedside tables



140 Comodini Soft /
Soft bedside tables



141 Casellari sospesi Luce /
Luce wall units



142 Comodini Becky /
Becky bedside tables



143 Tavolini Laby /
Laby side tables



144 Panche /
Benches



146 Tavolini e vassoi /
Side tables and trays

COMODINI / BEDSIDE TABLES



COMODINI P 45,4 CM / BEDSIDE TABLES D 45,4 CM

COMODINI A TERRA, SU GAMBE E PENSILI* / BEDSIDE TABLES SITTING ON THE FLOOR, LEGS OR WALL*



GAMBE / LEGS



* Pensili fino ad H 57,8 cm. / Wall units up to H 57,8 cm.

COMODINI SU RUOTE / BEDSIDE TABLES ON CASTORS



COMODINI P 45,4 CM /
BEDSIDE TABLES D 45,4 CM

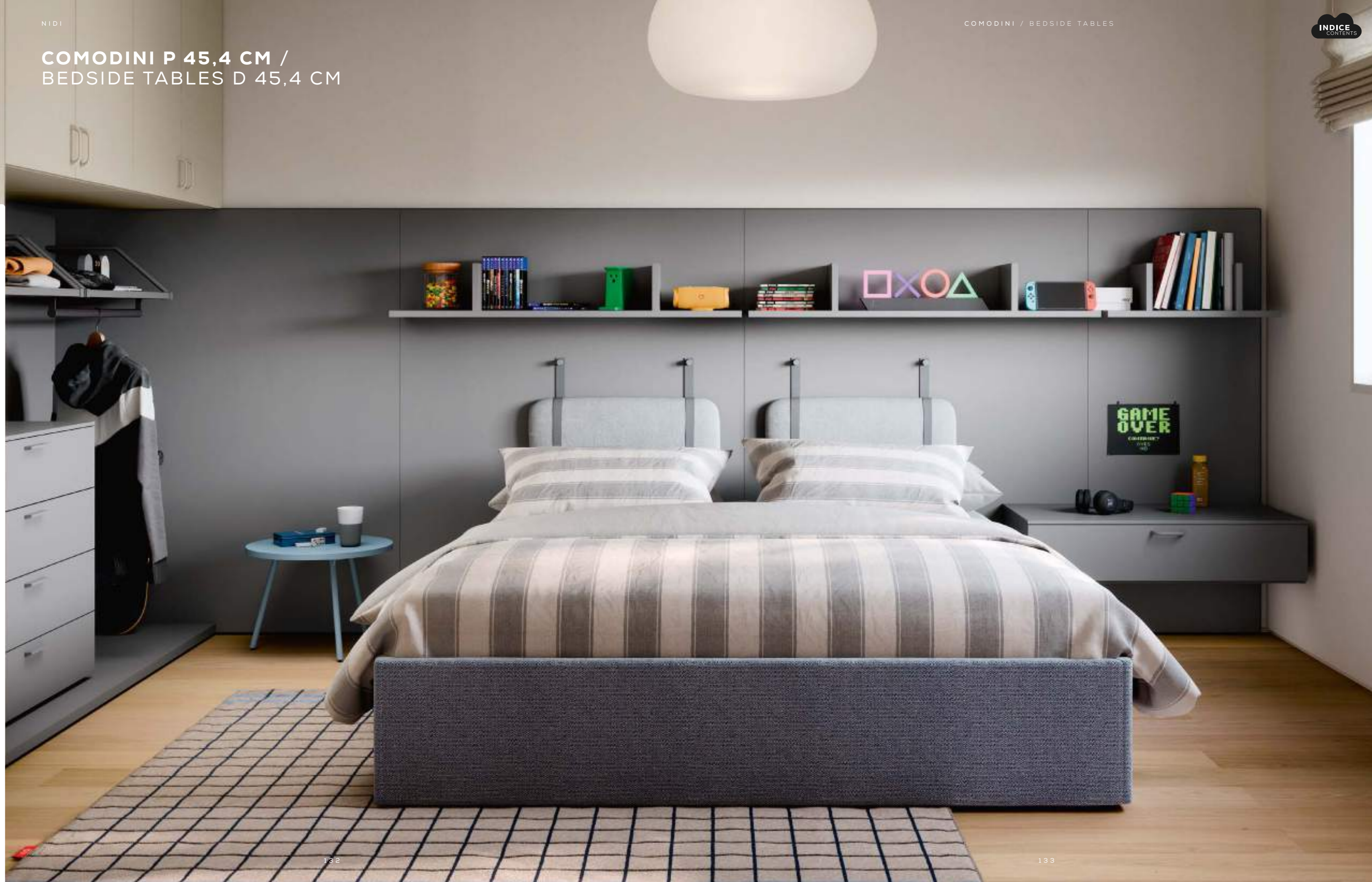



ELEMENTO JACK / JACK UNIT

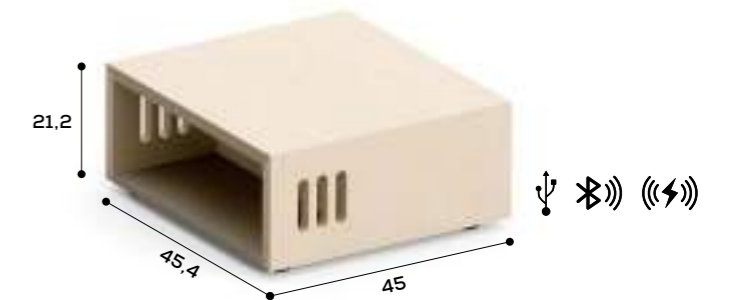
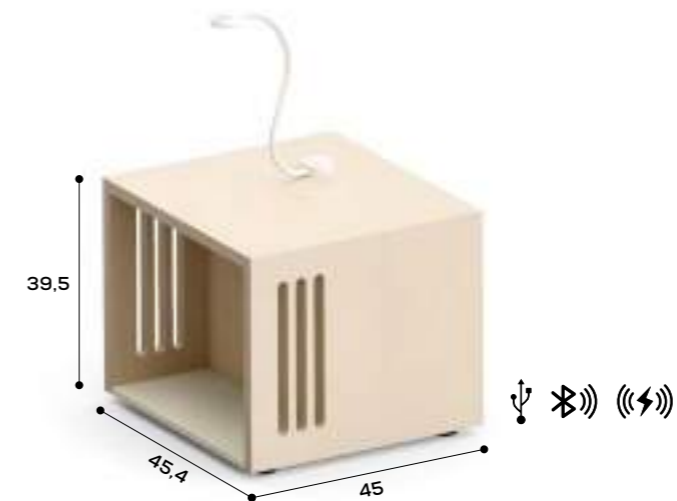
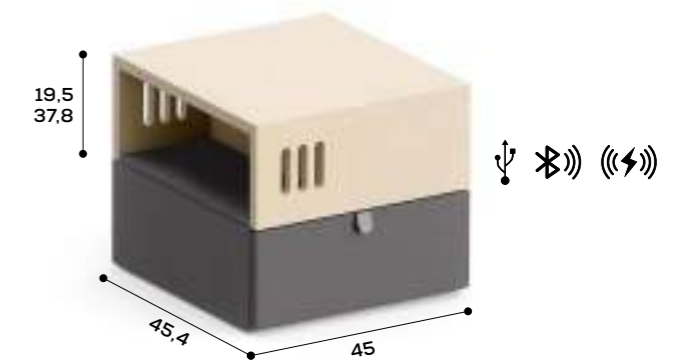

Doppia presa USB /
Double USB socket



Casse acustiche Bluetooth /
Bluetooth speakers



Ricarica wireless sottopiano /
Undermounted wireless charging

Elemento Jack sp. 2,2 in finitura legno naturale.

È disponibile in diverse versioni: doppia presa USB, doppia presa USB e casse acustiche Bluetooth, doppia presa USB e ricarica wireless sottopiano, doppia presa USB, casse acustiche Bluetooth e ricarica wireless sottopiano. /

Jack unit 2,2 cm thick in legno naturale finish.

It comes in a number of versions: double USB socket; double USB socket and Bluetooth speakers; double USB socket and undermounted wireless charging; double USB socket, Bluetooth speakers and undermounted wireless charging.

COMODINI WILSON / WILSON BEDSIDE TABLES

COMODINI SU GAMBE LABY P 45,4 CM / BEDSIDE TABLES ON LABY LEGS D 45,4 CM



COMODINI SU RUOTE P 45,4 CM / BEDSIDE TABLES ON CASTORS D 45,4 CM



ACCESSORI / ACCESSORIES

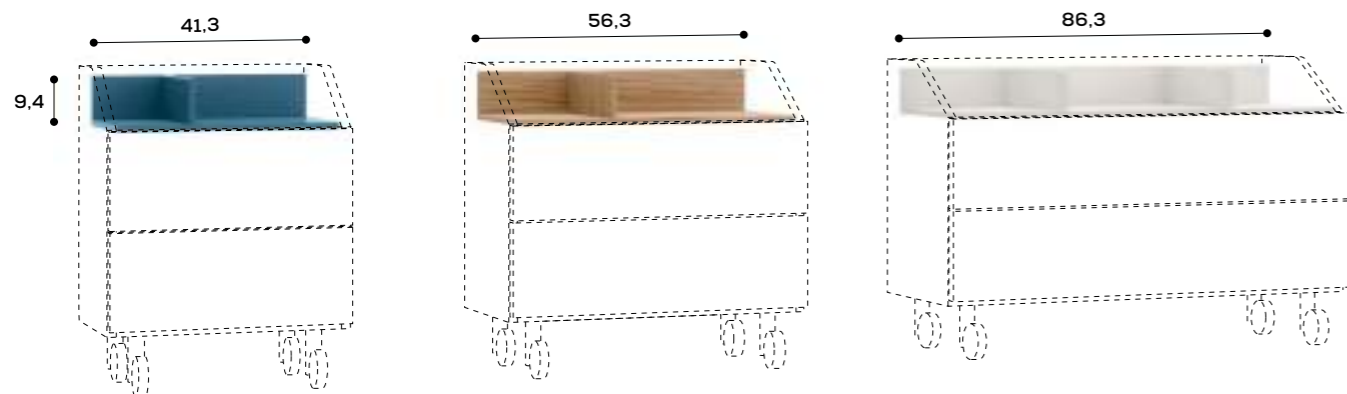

COMODINI LUCE / LUCE BEDSIDE TABLES

COMODINI SOSPESI / WALL-MOUNTED BEDSIDE TABLES

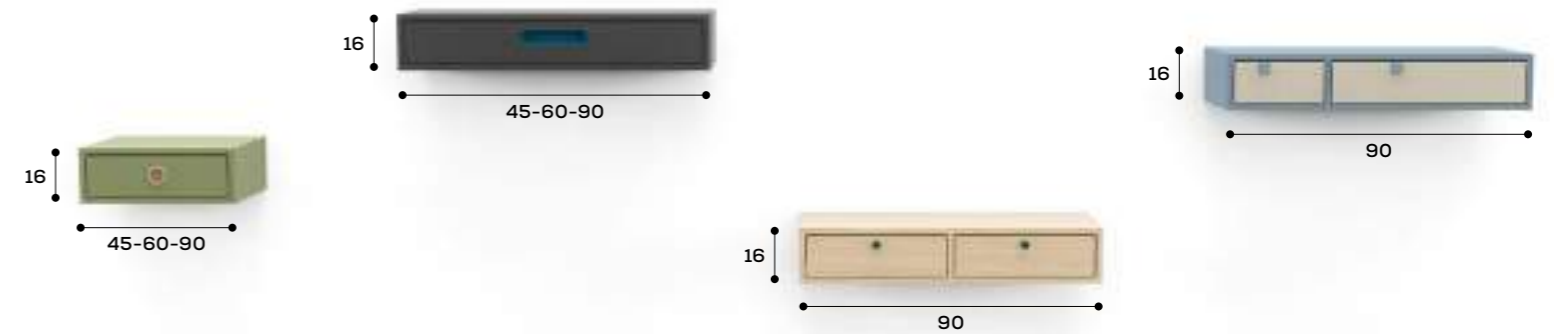

Profondità 43 cm /
43 cm deep

COMODINI SU GAMBE LABY / BEDSIDE TABLES ON LABY LEGS



Profondità 43 cm /
43 cm deep



COMODINI SOFT / SOFT BEDSIDE TABLES

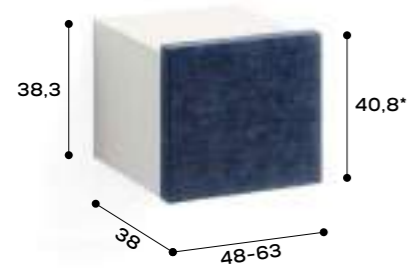

* Nella versione a terra l'altezza totale è 40,2 cm. /
With the floorstanding version, the total height is 40,2 cm.



CASELLARI SOSPESI LUCE / LUCE WALL UNITS

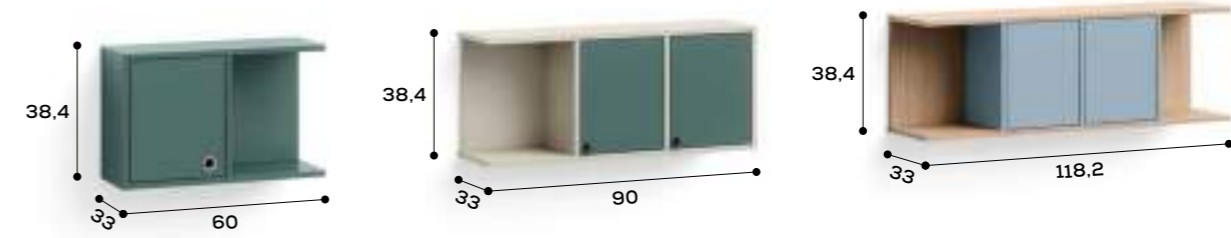

**COMODINI BECKY /
BECKY BEDSIDE TABLES**

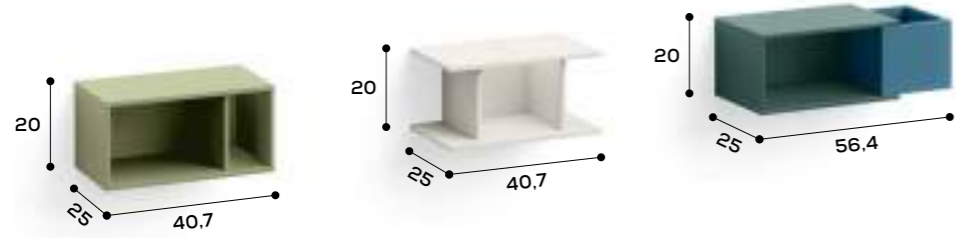

**TAVOLINI LABY /
LABY SIDE TABLES**

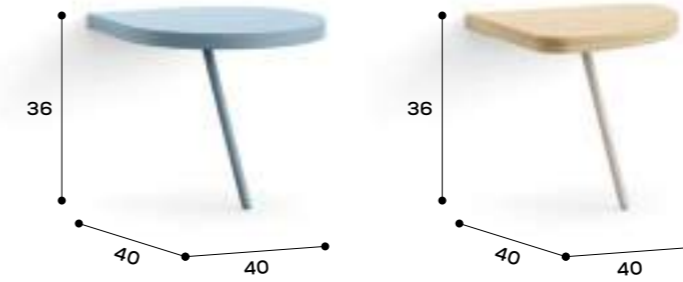

PANCHE / BENCHES

COMODINO SAGOMATO NIKO / NIKO SHAPED BEDSIDE TABLE

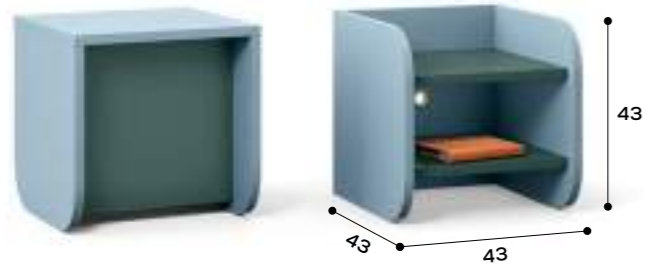

Sp. 2,2 cm. Sempre con maniglia In sulla schiena. /
2,2 cm thick Always has In handle on back panel.

PANCHE DORY / DORY BENCHES



Panca Dory per contenitori Tynn /
Dory bench for Tynn storage boxes

Panca Dory sagomata /
Shaped Dory bench



TAVOLINI E VASSOI / SIDE TABLES AND TRAYS

TAVOLINI /
SIDE TABLES



P/D 45 cm



VASSOIO H 42 CM /
TRAY H 42 CM



SCRITTOI DESKS

Gli scrittoi sono progettati per adattarsi a diverse esigenze. Le varie opzioni di dimensioni e spessori dei piani, insieme agli accessori integrabili, offrono soluzioni su misura per angoli studio funzionali. Diverse sono le tipologie di gambe tra cui scegliere, per personalizzare al meglio lo spazio studio.

Our desks are designed to suit different requirements. With a range of different top sizes and thicknesses, along with the option of incorporating accessories, they offer custom solutions for functional study nooks. There are various leg types to choose from, for a study space perfectly tailored to individual needs.

04 SCRITTOI / DESKS



150 Scrittoi /
Desks



156 Scrittoi sp. 3 - 5 cm /
Desks 3 - 5 cm thick



166 Piani sosopesi con alzata /
Wall-mounted tops with upstand

SCRITTOI / DESKS

SCRITTOI LUCE /
LUCE DESKS



SCRITTOIO VANNY /
VANNY DESK



Con piano melaminico sp. 2,2 cm e gambe Ask. /
With 2,2cm-thick melamine top and Ask legs.

SCRITTOIO LEO /
LEO DESK



Con piano melaminico sp. 3 cm e casellario sp. 1,8 cm. /
With 3cm-thick melamine top and hutch 1,8 cm thick.

SCRITTOIO YUCCA /
YUCCA DESK



GAMBE /
LEGS



Ask



Clessidra

ACCESSORI /
ACCESSORIES

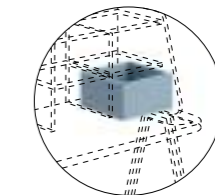

Cassetto L 28, sp. 1,2 cm /
Box W 28, 1,2 cm thick

ACCESSORI /
ACCESSORIES

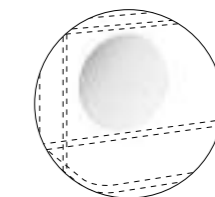

Specchio Giro Ø 43 cm /
Giro mirror Ø 43 cm

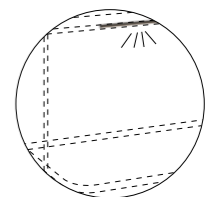

Lampada LED /
LED light

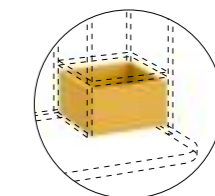

Cassetto L 28, sp. 1,2 cm /
Box W 28, 1,2 cm thick

SCRITTOI / DESKS

SCRITTOIO WILLIAM /
WILLIAM DESK

Piano posizionabile su tre altezze: 53, 63, 73 cm. /
Top with three height settings: 53, 63, 73 cm.

SCRITTOI / DESKS

SCRITTOI SECRET /
SECRET DESKS



Disponibili con gambe Ask o Woody.
Accessori: specchio Giro. /
Available with Ask or Woody legs.
Accessories: Giro mirror.



SCRITTOIO LOOP /
LOOP DESK



Piano sagomato sp. 3 cm, profondità 61 cm. /
Shaped top 3 cm thick, 61 cm deep.

Sono disponibili gli accessori borsa portaoggetti, multitasca
portaoggetti e gancio appendiabito, vedi pag. 276. /
Available accessories include hanging bag organizer, multi-pocket
organizer and coat hook, see page 276.



SCRITTOI / DESKS

SCRITTOI SP. 3 - 5 CM / DESKS 3 - 5 CM THICK

Crea la scrivania su misura. Scegli tra forme, spessori e configurazioni personalizzabili per adattare lo scrittoio all'angolo studio. Diverse opzioni di gambe, fianchi e contenitori permettono di creare la combinazione ottimale per lo studio di bambini e ragazzi.

Create a custom desk. Choose your preferred shape, thickness and configuration to tailor the desk to suit the study nook. Different leg, side and storage options allow you to create the perfect study space combination for kids, teens and young adults.



PIANI / TOPS



Spessori / Thicknesses



SUPPORTI PER SCRITTOI / DESK SUPPORTS



cassettiera con distanziale fisso / drawer unit with fixed spacer

cassettiera con vano a giorno / drawer unit with open shelf

fianco libreria / bookcase side panel

comodino Luce / Luce bedside table

STAFFA AD L PER FISSAGGIO PIANO / L-SHAPED BRACKET FOR TOP MOUNTING

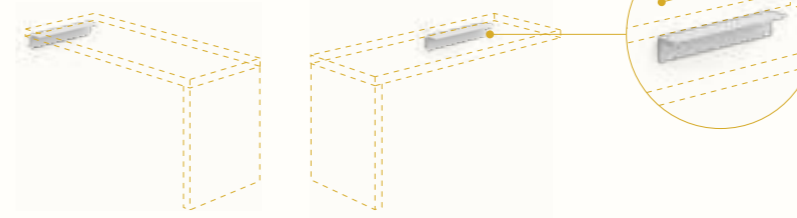

GAMBE / LEGS



Kike

Loom

Poly

Ask

Clessidra

Woody

* Gamba Kike allungabile. / Kike extending leg.

FIANCHI / SIDE PANELS

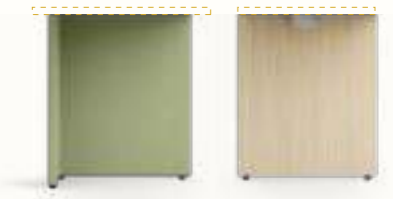

Fianco ad "L" / L-shaped side panel

Fianco / Side panel

ACCESSORI / ACCESSORIES

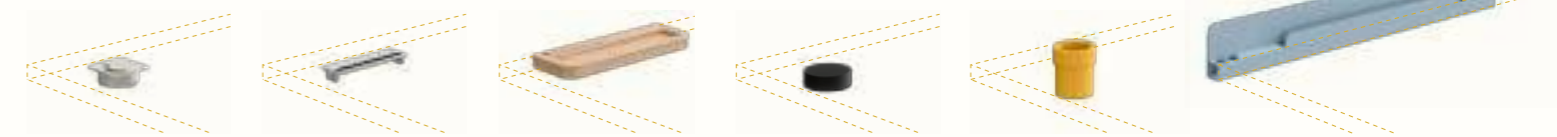

Boccola passacavi circolare in metallo / Metal round wiring grommet

Boccola passacavi rettangolare in metallo / Metal rectangular wiring grommet

Passacavi e portapenne Pool in legno / Pool wooden pen holder and wiring grommet

Ricarica wireless sottopiano / Undermounted wireless charging

Portapenne in legno laccato / Lacquered wood pen holder

Folder in metallo sp. 0,2 cm / Metal Folder 0,2 cm thick

SCRITTOI SP. 3 - 5 CM /
DESKS 3 - 5 CM THICK



SCRITTOI / DESKS

SCRITTOI SP. 3 - 5 CM /
DESKS 3 - 5 CM THICK

ELEMENTO FOLDER PER PIANO L 150 /
FOLDER UNIT FOR TOP 150 WIDE

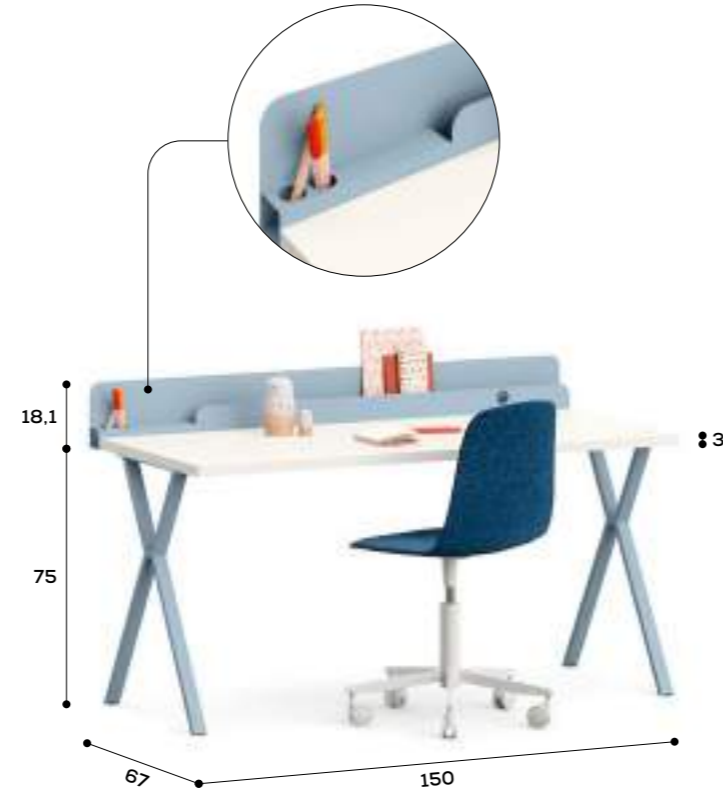
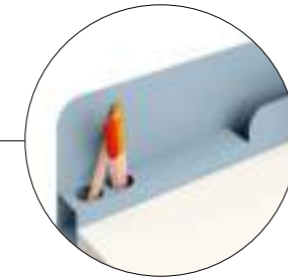

PASSACAVI E PORTAPENNE POOL /
POOL PEN HOLDER AND WIRING GROMMET



PASSACAVI RETTANGOLARE IN METALLO /
METAL RECTANGULAR WIRING GROMMET

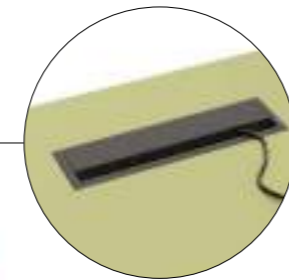

CASSETTO LUCE
PENSILE SOTTOPIANO /
LUCE UNDERMOUNTED
DRAWER



SCRITTOI / DESKS

SCRITTOI SP. 3 - 5 CM /
DESKS 3 - 5 CM THICK

FIANCO IN APPOGGIO /
SIDE PANEL SITTING ON UNIT



VASSOIO GIREVOLE /
SWING-OUT TRAY



PORTAPENNE IN LEGNO /
WOODEN PEN HOLDER

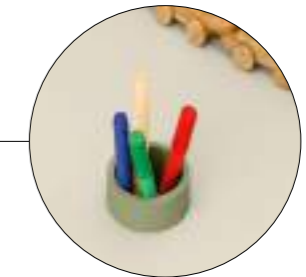

PIANO SAGOMATO
REALIZZATO A MISURA /
CUSTOM-SHAPED TOP



SCRITTOI / DESKS

SCRITTOI SP. 3 - 5 CM /
DESKS 3 - 5 CM THICK

BOCCOLA PASSACAVI
CIRCOLARE IN METALLO /
METAL ROUND WIRING
GROMMET



PIANO SAGOMATO
REALIZZATO A MISURA /
CUSTOM-SHAPED TOP



GAMBA CLESSIDRA /
CLESSIDRA LEG

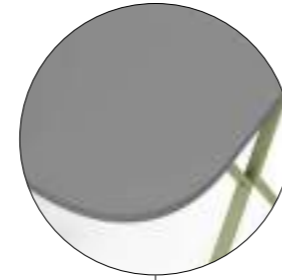

RICARICA WIRELESS SOTTOPIANO /
UNDERMOUNTED WIRELESS CHARGING



PIANI SOSPESI CON ALZATA / WALL-MOUNTED TOPS WITH UPSTAND



Disponibile anche con 1 o 2 angoli arrotondati R. 5 cm. /
Also available with 1 or 2 rounded corners R. 5 cm.



SEDUTE SEATING

Trasforma la camera di bambini e ragazzi in uno spazio divertente e accogliente con pratiche e colorate sedute. Progettate per offrire comfort e stimolare la creatività, queste sedie sono perfette per leggere, disegnare o semplicemente rilassarsi.

Whether the room is for kids, teens or young adults, it can be turn into a fun comfortable space with practical and colourful seating. Designed to offer comfort and stimulate creativity, these seating options are perfect for reading, drawing or simply relaxing.

05 SEDUTE / SEATING



170 Sedie /
Chairs



179 Sgabelli /
Stools

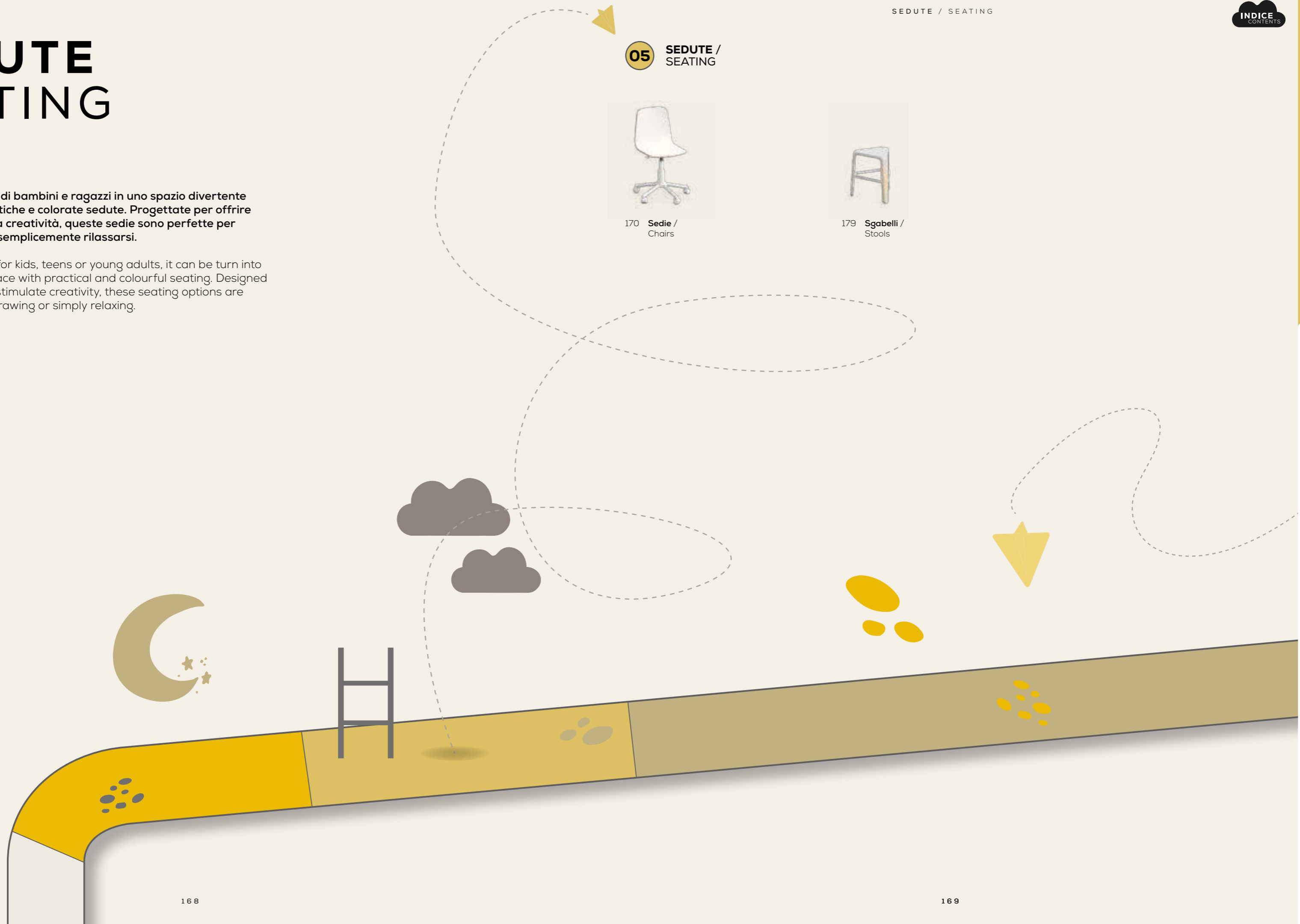

SEDUTE / SEATING

SEDIE / CHAIRS

PILL



L/W 55 x P/D 53 cm



L/W 61 x P/D 58 cm

87

FINITURE BASAMENTI E STRUTTURA /
BASE AND FRAME FINISHES



bianco lavagna

Sedile e schienale imbottiti e rivestiti con rivestimento Dalia. /
Padded seat and backrest upholstered in Dalia.

GIANT



L/W 47 x P/D 54 cm

79



FINITURE / FINISHES



J00 J54 J21

MARÌ



L/W 61 x P/D 58 cm

85



L/W 55 x P/D 55 cm

85

FINITURE BASAMENTI /
BASE FINISHES

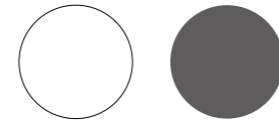

bianco lavagna

FINITURE BOTTONE /
BUTTON FINISHES

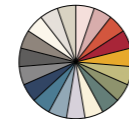

Disponibile in tutte le finiture colore. /
Available in all colour finishes.

Sedile e schienale in polipropilene finitura bianca. /
Polypropylene seat and backrest in white finish.

AVA



L/W 70 x P/D 66 cm

97



Struttura in polipropilene e tessuto nelle finiture:
- nero e tessuto grigio scuro
- bianco e tessuto grigio chiaro. /
Polypropylene frame with fabric, finish options:
- black with dark grey fabric
- white with light grey fabric.

BASAMENTI / BASES



R1

R8

SEDIE / CHAIRS

TAK



L/W 43 x P/D 51 cm



L/W 61 x P/D 58 cm



L/W 55 x P/D 53 cm

BASAMENTO PER SEDUTA IN MULTISTRATO / BASE FOR PLYWOOD SEAT



R5

R1

R8

Seduta in multistrato di faggio in finitura bianca. / Beech plywood seat in white finish.

BASAMENTO PER SEDUTA IMBOTTITA / BASE FOR PADDED SEAT



R5

Seduta in multistrato di faggio imbottita e rivestita in tutti i tessuti. / Seat made from padded beech plywood upholstered in all fabrics.

FINITURE BASAMENTI CON RUOTE / SWIVEL BASE FINISHES

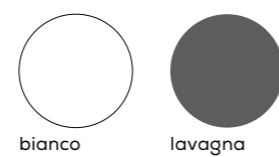

bianco

lavagna

FINITURE BASAMENTO R5 / R5 BASE FINISHES

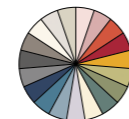

Disponibile in tutte le finiture colore. / Available in all colour finishes.





SEDUTE / SEATING

SEDIE /
CHAIRS

POD



BASAMENTI / BASES

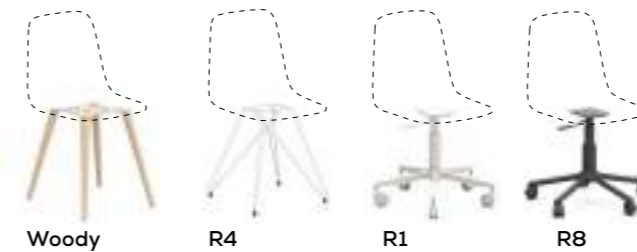

Seduta in multistrato di faggio imbottita e rivestita in tutti i tessuti. /
Seat made from padded beech plywood upholstered in all fabrics.

FINITURE BASAMENTI CON RUOTE /
SWIVEL BASE FINISHES

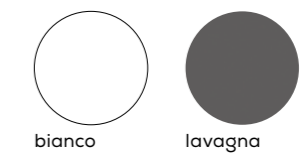

FINITURE BASAMENTO WOODY /
WOODY BASE FINISHES



FINITURE BASAMENTO R4 /
R4 BASE FINISHES

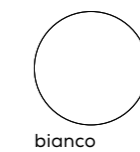

SEDIE / CHAIRS

LEAF



FINITURE BASAMENTI CON RUOTE / SWIVEL BASE FINISHES

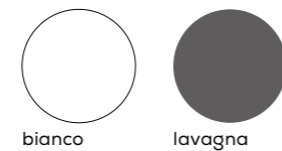

FINITURE BASAMENTO R4 / R4 BASE FINISHES

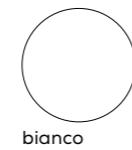

FINITURE BASAMENTO R3 / R3 BASE FINISHES

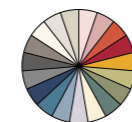

Disponibile in tutte le finiture colore. / Available in all colour finishes.

BASAMENTI / BASES



La seduta è in polipropilene finitura bianca. Disponibile anche nella versione imbottita o con cuscino imbottito. / Polypropylene seat in white finish. Also comes in padded version or with padded cushion.



SEDUTE / SEATING

SEDIE / CHAIRS

JOIN



L/W 61 x P/D 58 cm



L/W 46 x P/D 55 cm



L/W 55 x P/D 53 cm

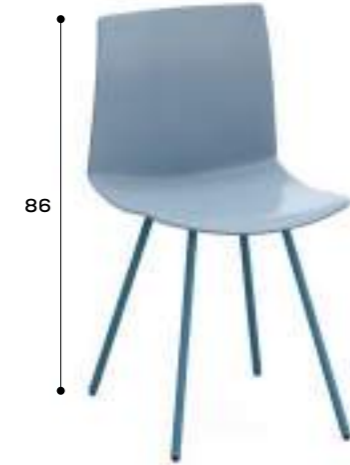

L/W 46 x P/D 55 cm

BASAMENTI / BASES



R3

R4

R1

R8

FINITURE SEDILE / SEAT FINISHES

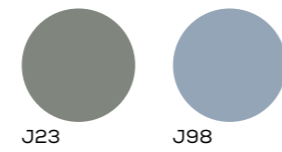

FINITURE BASAMENTI CON RUOTE / SWIVEL BASE FINISHES

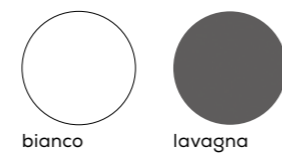

FINITURE BASAMENTO R4 / R4 BASE FINISHES

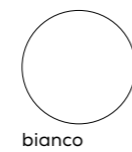

FINITURE BASAMENTO R3 / R3 BASE FINISHES

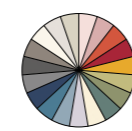

Disponibile in tutte le finiture colore. / Available in all colour finishes.

SGABELLI / STOOLS

MILK



Ø32



OSCAR



L/W 44,2 x P/D 38,3 cm



FINITURE SEDILE / SEAT FINISHES

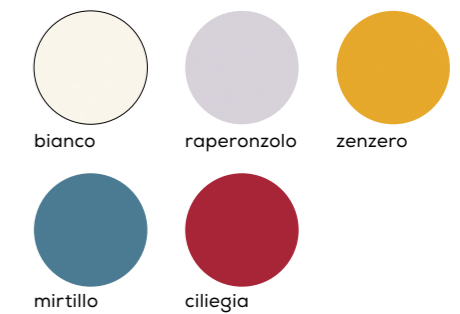

Gambe in metallo finitura bianco. / Metal legs in white finish.

Gambe in tinta legno naturale. Sedile in plastica nei colori bianco o nero. / Legs in legno naturale finish. Plastic seat in choice of white or black.

COMPLEMENTI COMPLEMENTS

I complementi d'arredo, come pouf, cassapanche e specchiere, completano l'estetica della stanza aggiungendo funzionalità. Ogni elemento è progettato per decorare con stile l'ambiente. Le finiture e i tessuti sono disponibili in una vasta gamma di colori.

Complements like ottomans, chests and mirrors add the finishing touch to the room's look while also bringing functionality. Each item is designed to decorate the interior with style. Finishes and fabrics come in an extensive range of colours.

06 COMPLEMENTI / COMPLEMENTS



182 **Pouf /**
Ottomans-floor cushions



190 **Scalette a muro /**
Wall ladders



198 **Stickers /**
Stickers



188 **Cassapanche /**
Chests



190 **Appendiabiti /**
Coat hooks

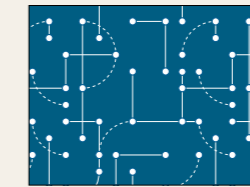

202 **Carte da parati /**
Wallpaper



190 **Portagiochi /**
Toy boxes



192 **Tappeti /**
Rugs



212 **Specchiere /**
Mirrors

COMPLEMENTI / COMPLEMENTS

POUF /
OTTOMANS-FLOOR CUSHIONS

CUBE

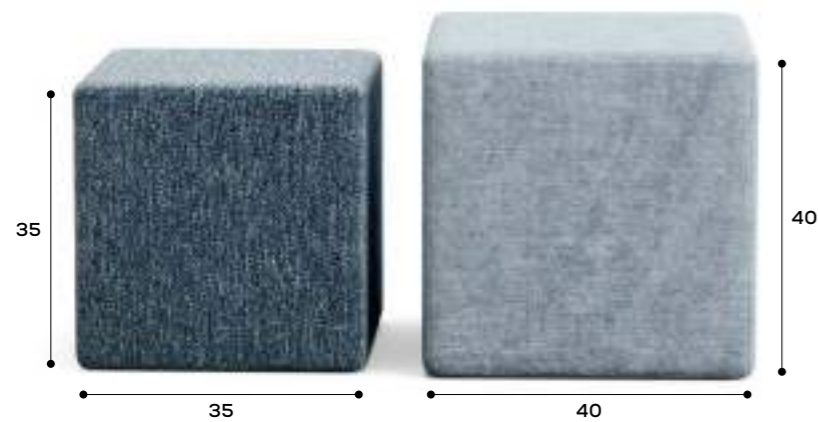

Il pouf Cube è proposto in due misure: small e medium. Completamente sfoderabile in tutti i tessuti. Ideale come seduta aggiuntiva o elemento decorativo versatile. /
The Cube ottoman comes in two sizes: small and medium. It has fully removable covers available in any of the fabric options. Ideal as extra seating or as a versatile decorative piece.

NOEL



Noel è un pouf cilindrico con una fessura portaoggetti che lo rende unico e funzionale. Disponibile in tutti i tessuti e sfoderabile, Noel si adatta alla camera di bambini e ragazzi offrendo un tocco di originalità. /
Noel is a cylindrical ottoman with a storage slot that makes it both unique and functional. Available in all fabrics and with removable covers, Noel makes a great addition to a kid's, teen or young adult's bedroom, offering a touch of originality.

ELLO



Il pouf Ello si distingue per la sua forma conica. Sfoderabile e disponibile in una vasta gamma di tessuti, può essere arricchita da una cucitura decorativa punto cavallo rovescio, che aggiunge un tocco distintivo. /

The Ello ottoman stands out for its tapered shape. With removable covers and an extensive range of fabric options, it can be embellished with decorative reverse blanket stitching, which adds a distinctive touch.

DISCO



Disco è un pouf rotondo, ideale per spazi informali. La sua forma semplice lo rende perfetto come seduta extra o elemento decorativo. Disponibile in diversi tessuti e sfoderabile, può essere personalizzato con una cucitura punto cavallo dritto. /

Disco is a round floor cushion, ideal for casual spaces. Its simple shape makes it perfect for use as extra seating or a decorative element. Available in a range of fabrics and with removable covers, it can be customized with regular blanket stitching.

POUF / OTTOMANS-FLOOR CUSHIONS

BLOOM



Il pouf Bloom si distingue per la sua forma avvolgente, ideale come comodo appoggio per letture pomeridiane. È sfoderabile e disponibile in tutti i tessuti. / The Bloom floor cushion stands out for its cocooning shape, ideal for flopping down on for some after-school reading. It has a removable cover and is available in all fabrics.

IORI - KLOVE

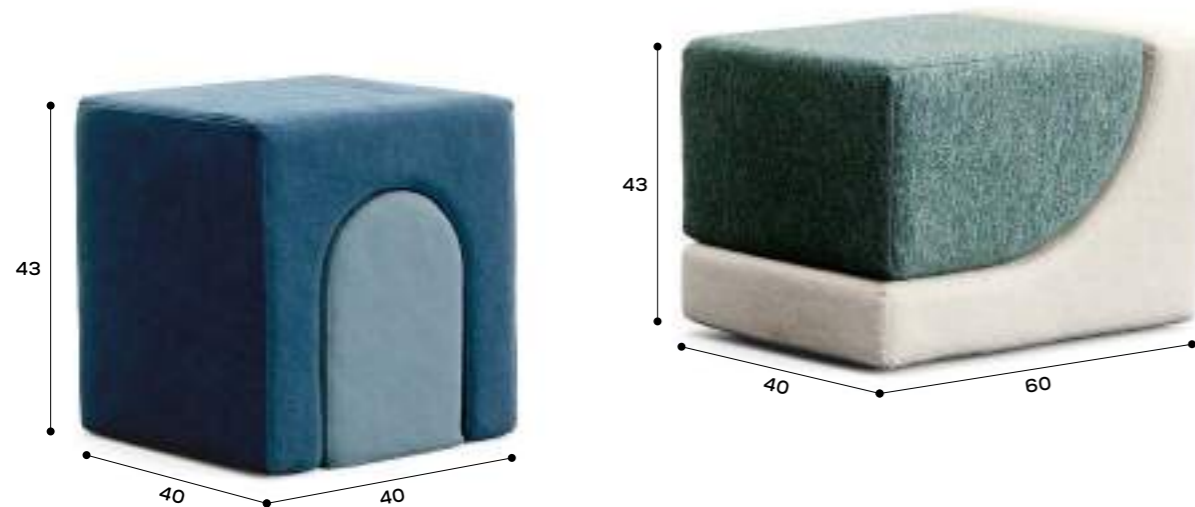

I pouf Iori e Klove sono ognuno composto da due elementi che possono essere combinati o utilizzati singolarmente, aggiungendo vivacità alla camera di bambini e ragazzi. Sono sfoderabili e disponibili in vari tessuti. / The Iori and Klove ottomans are both made up of two parts that can be combined or used individually, adding a cheerful feel to a kid's, teen or young adult's bedroom. They have removable covers and are available in a range of fabrics.



COMPLEMENTI / COMPLEMENTS

POUF /
OTTOMANS-FLOOR CUSHIONS

DOTS



Dots offre una seduta comoda e versatile. Disponibile in tutti i tessuti e sfoderabile, può trasformarsi in un letto aggiuntivo per dare più spazio al relax. / Dots offers comfortable, versatile seating. Available in all fabrics and with removable covers, it can be folded out into an extra bed so there's more space for hanging out.

CLIP



Clip, disponibile in tutti i tessuti e sfoderabile, può fungere da seduta per leggere, giocare o semplicemente rilassarsi. / Clip, which is available in all fabrics and has removable covers, can serve as seating for reading, playing or just chilling.

CASSAPANCHE / CHESTS

PANK



PANK PADDED

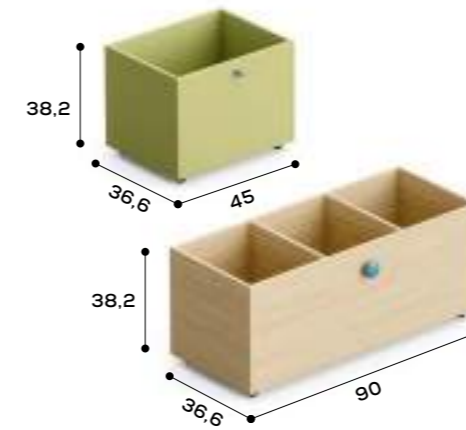

COMPLEMENTI / COMPLEMENTS

PORTAGIOCHI /
TOY BOXESSCALETTE A MURO /
WALL LADDERS

FLATTY

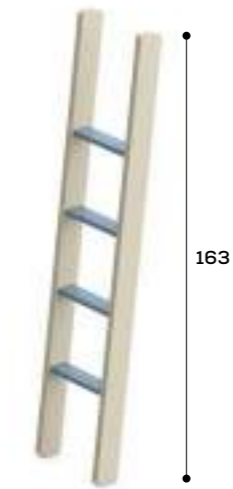

GRISÙ

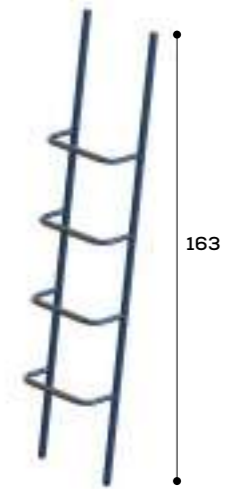
APPENDIABITI /
COAT HOOKS

WOODY

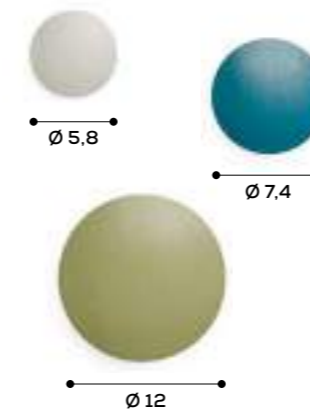

Disponibile in tutte le finiture. /
Available in all finishes.

FEFÈ



Disponibile in tutte le finiture colore. /
Available in all colour finishes.

PODDY



In ceramica con decoro a mano
azzurro, blu, verde, nero, giallo o
rosa. /
Ceramic hand decorated in light blue,
blue, green, black, yellow or pink.

PICK 2



In plastica bianco o lavagna. /
Plastic in bianco or lavagna finish.

COMPLEMENTI / COMPLEMENTS

TAPPETI /
RUGS

SKETCH



APPLE



POLAR BEAR

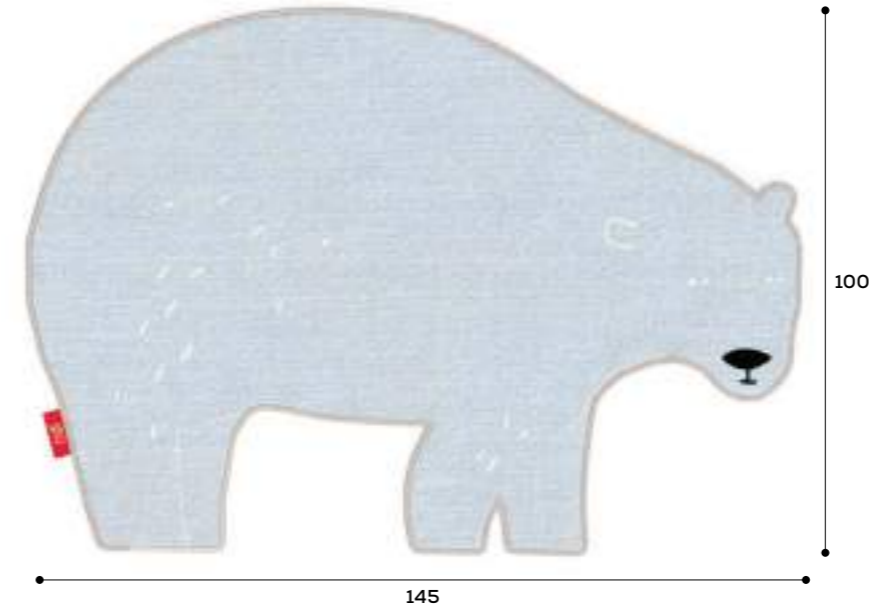

PARROT

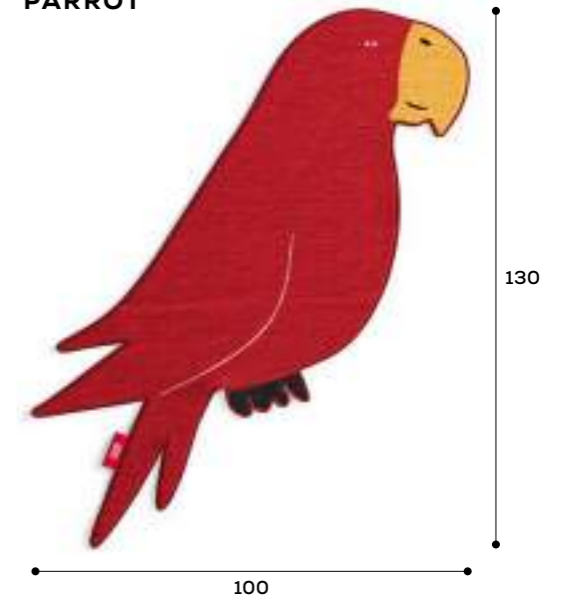

MUSHROOM

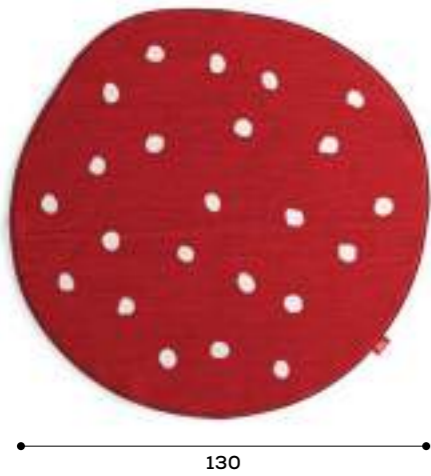

PLANET



WHALE

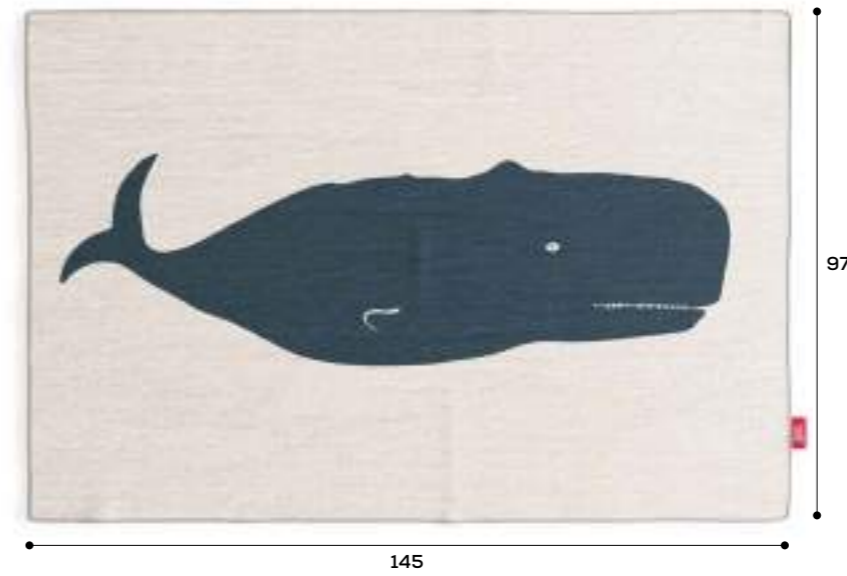

FELIX

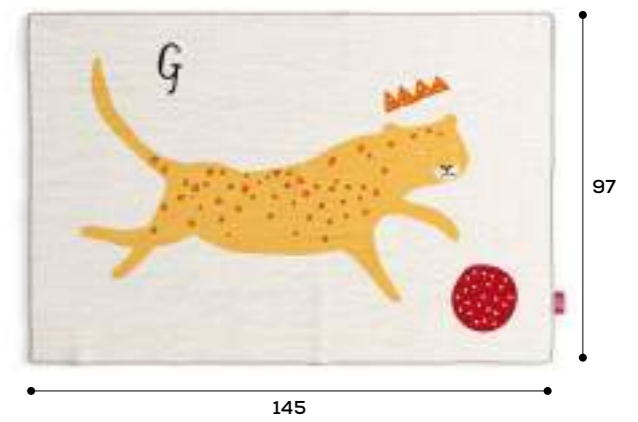

COMPLEMENTI / COMPLEMENTS

TAPPETI /
RUGS

TARTAN

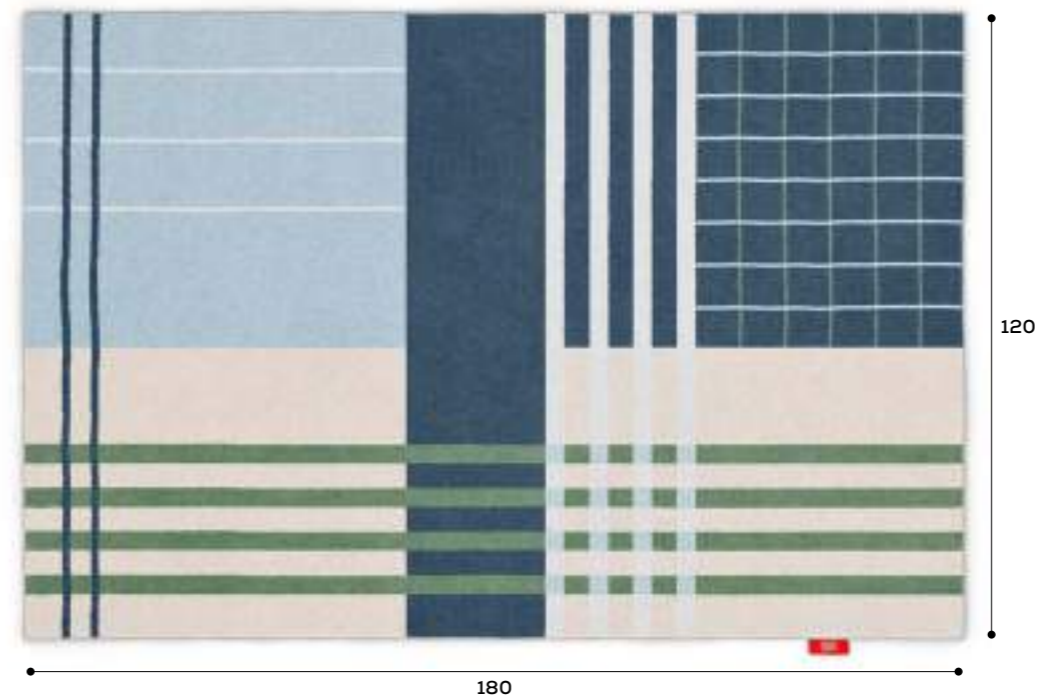

STARS BLUE

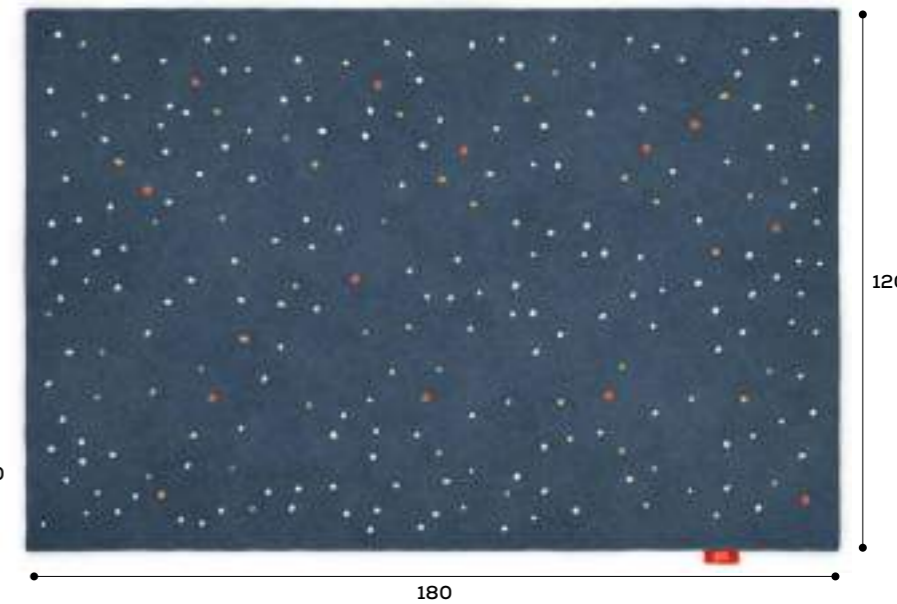

STARS BEIGE

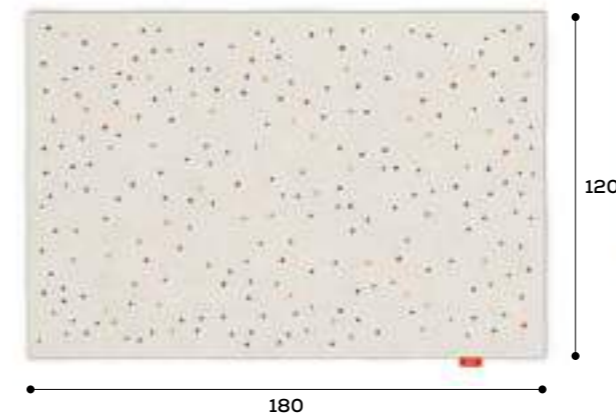

TAPPETI / RUGS

MATRIX BEIGE

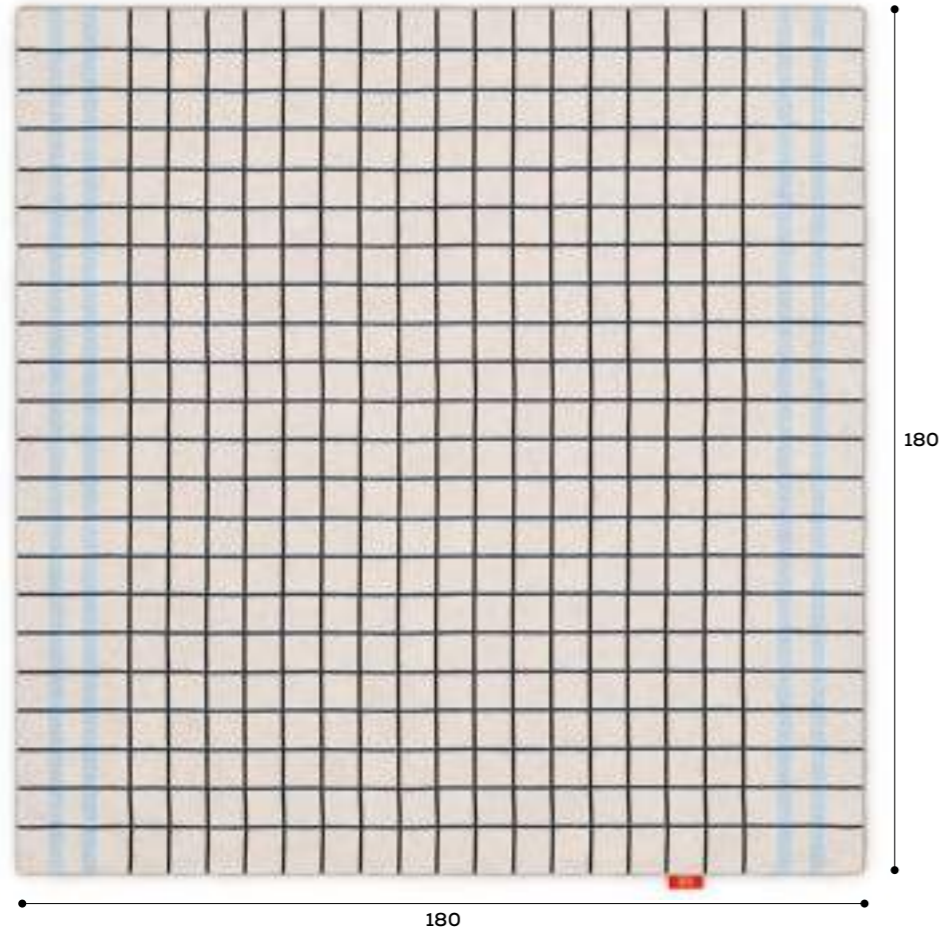

MATRIX BLUE

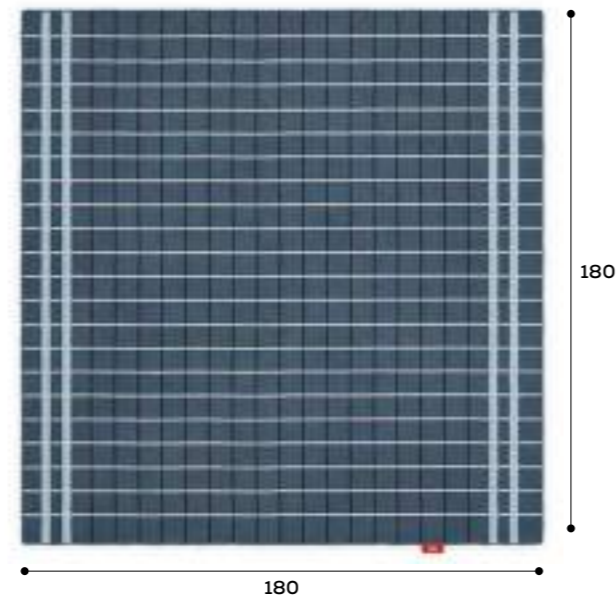

COMPLEMENTI / COMPLEMENTS

STICKERS /
STICKERS

ELEPHANT



LEOPARD

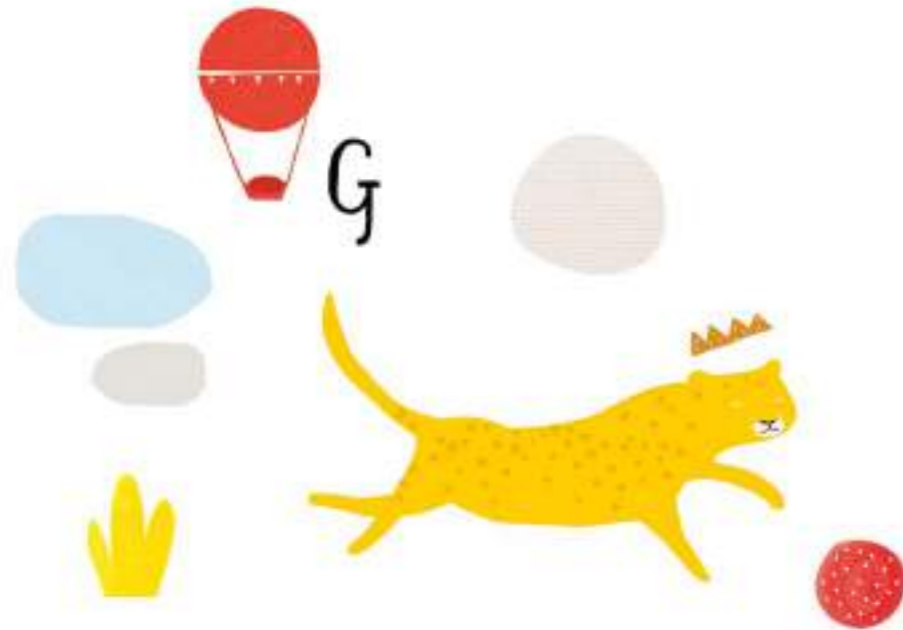

EMU



ARCTIC



STICKERS /
STICKERS



COMPLEMENTI / COMPLEMENTS

CARTE DA PARATI
WALLPAPER



COMPLEMENTI / COMPLEMENTS

CARTE DA PARATI /
WALLPAPER

Tutte le carte da parati sono fornite in rotoli L. 50 cm comprensivi di colla. /
All wallpaper comes in rolls 50 cm wide including paste.

CONNECTIONS WHITE

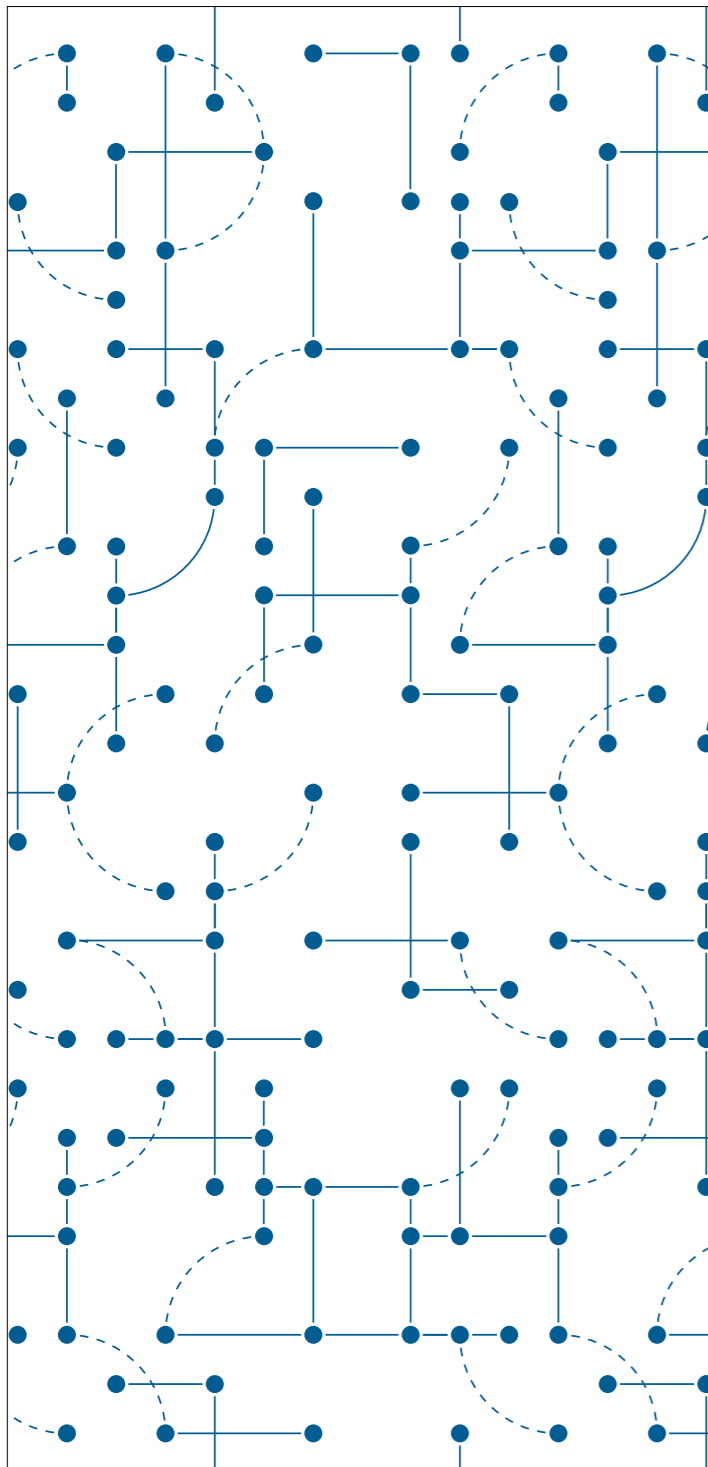

CONNECTIONS BLUE

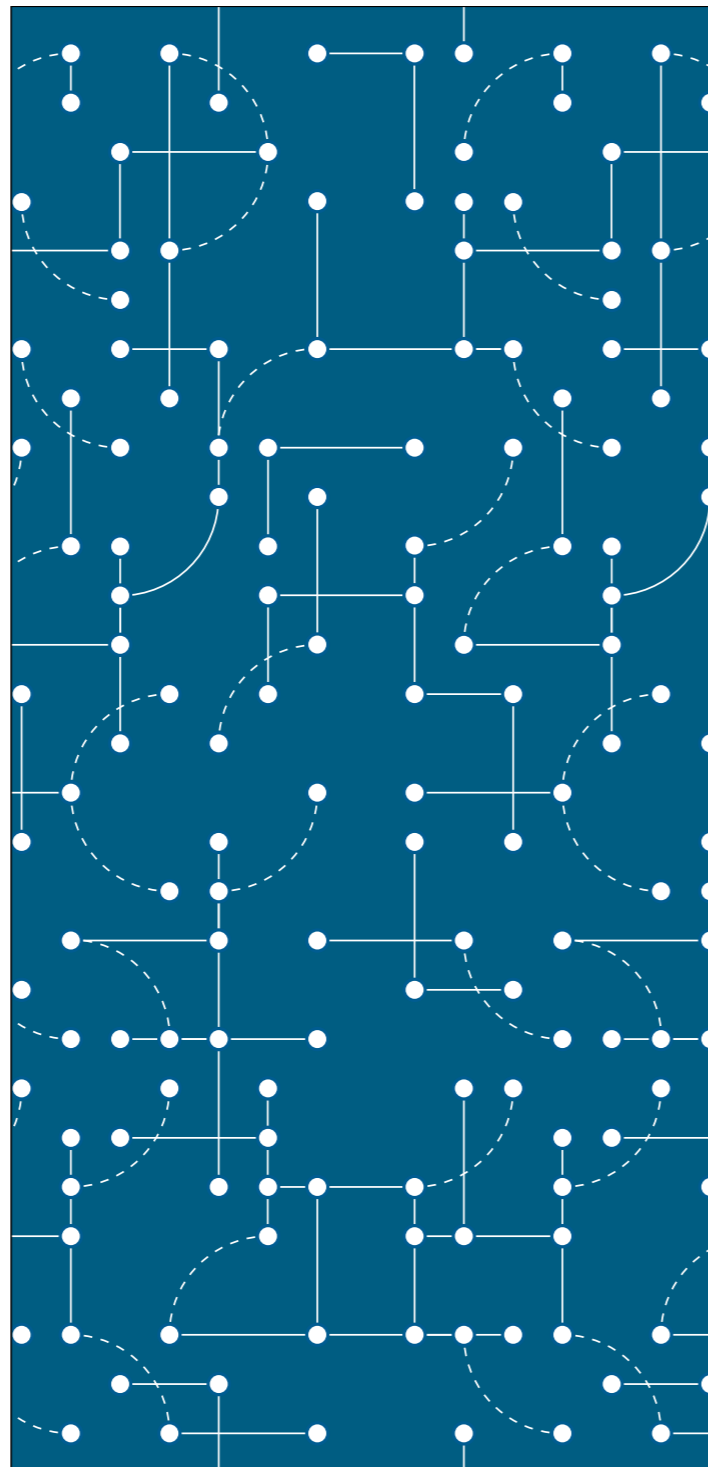

POP

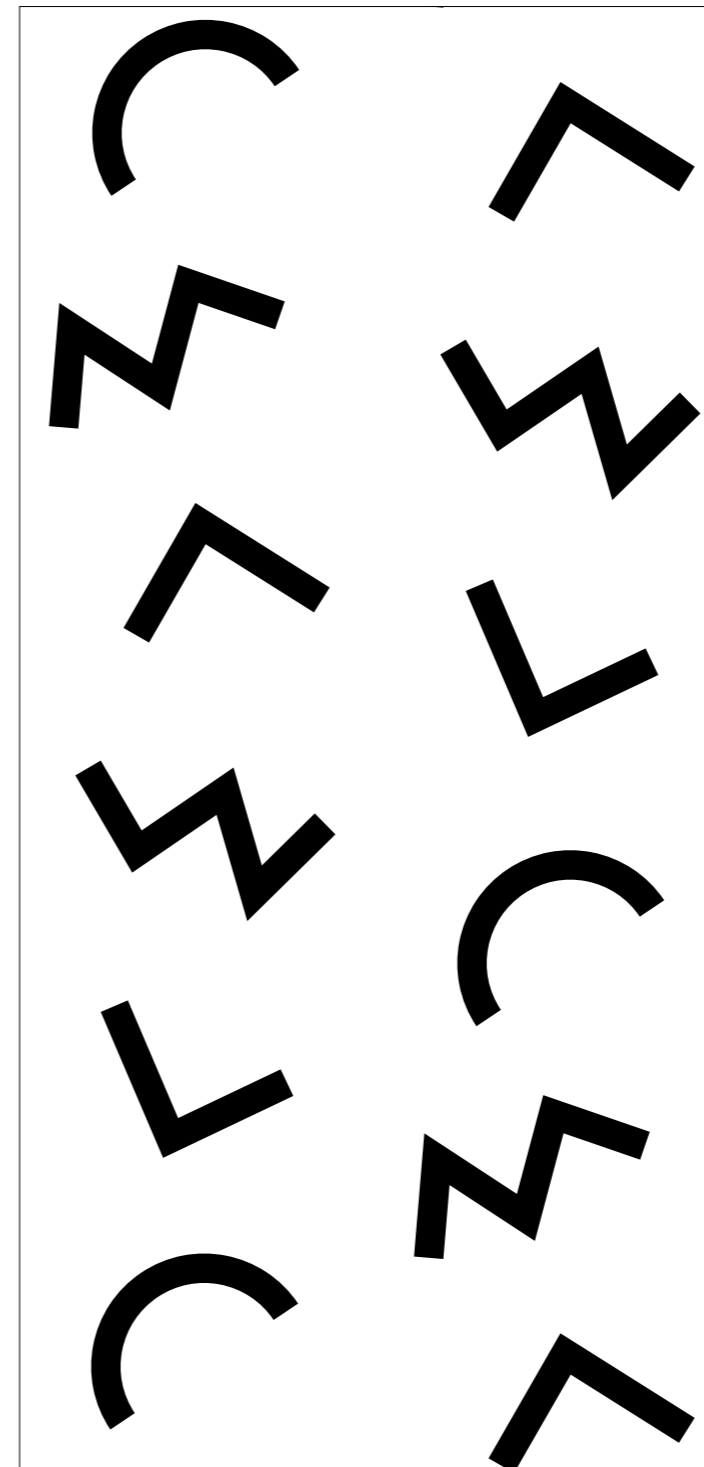

HERBARIUM



COMPLEMENTI / COMPLEMENTS

CARTE DA PARATI /
WALLPAPER

Tutte le carte da parati sono fornite in rotoli L. 50 cm comprensivi di colla. /
All wallpaper comes in rolls 50 cm wide including paste.

GALAXY BEIGE

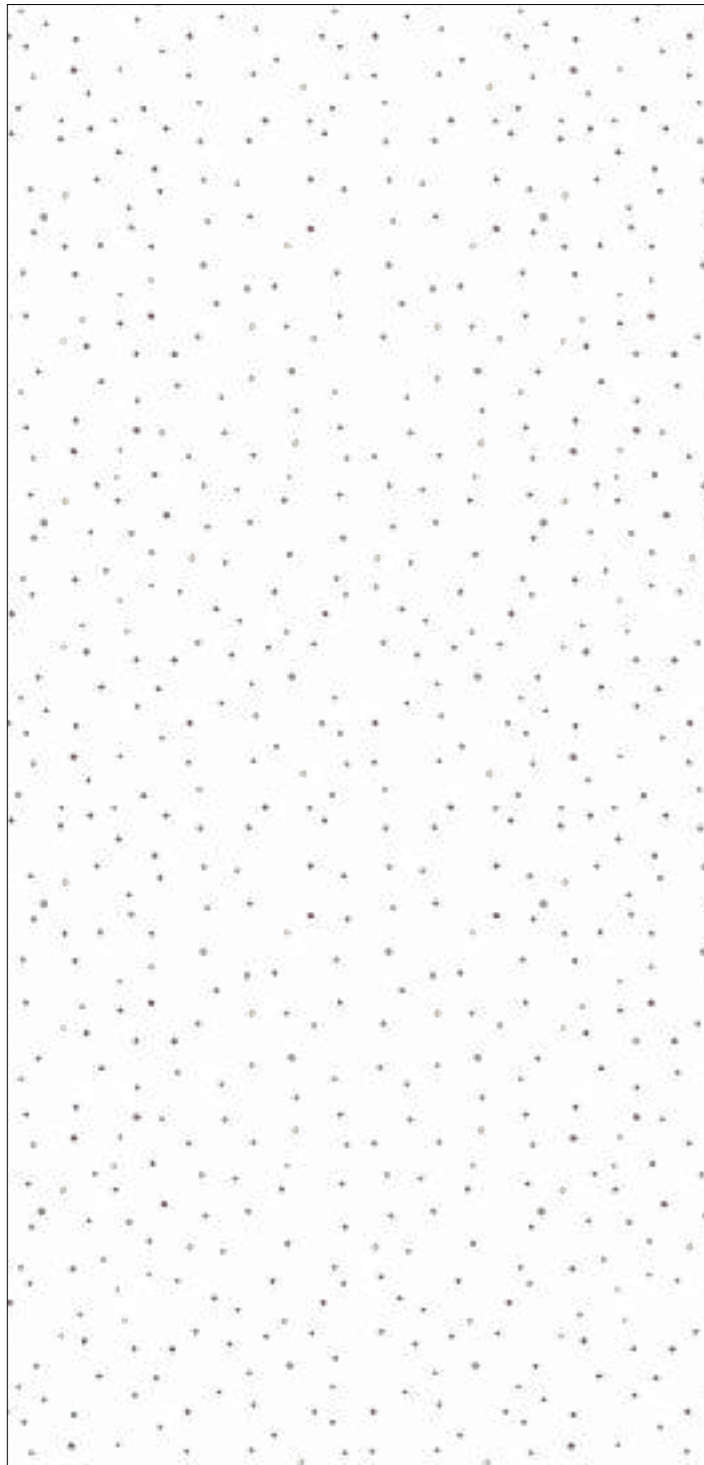

GALAXY BLUE



CROSSY BLACK

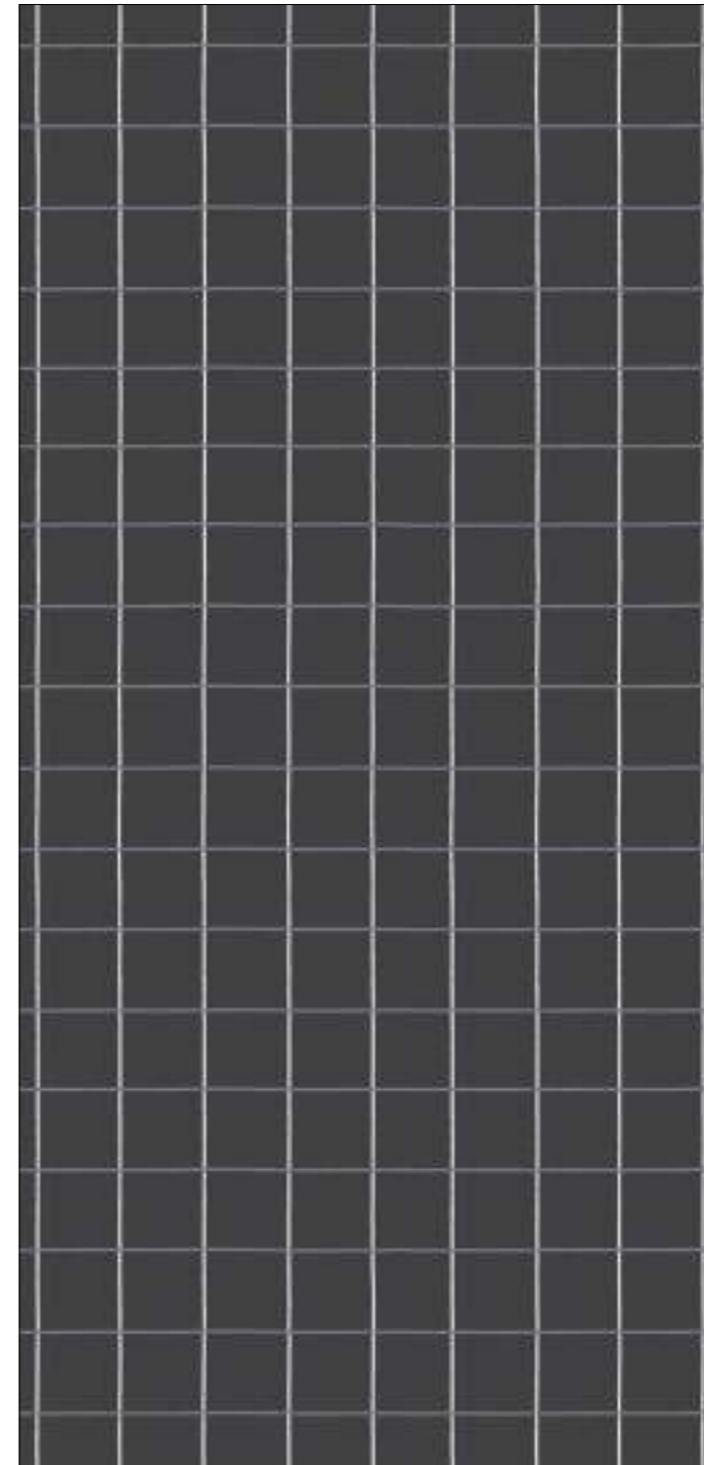

CROSSY BLUE

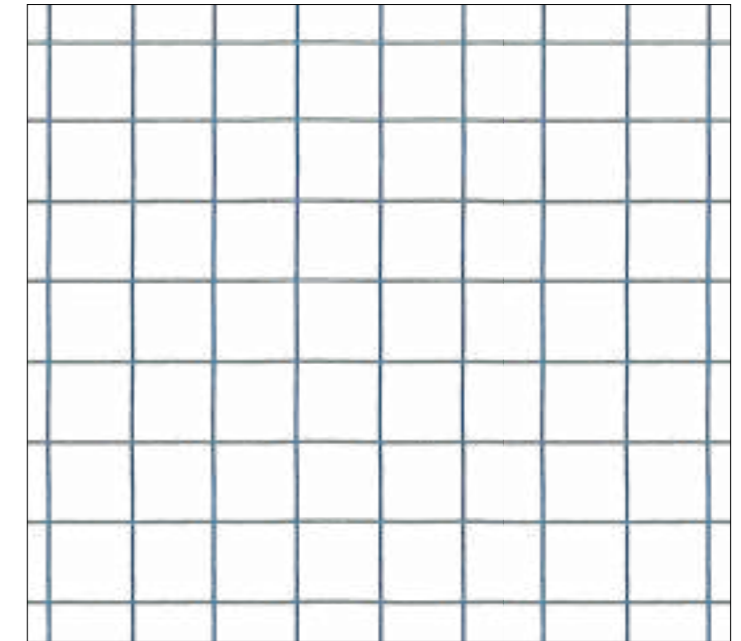

CROSSY ORANGE

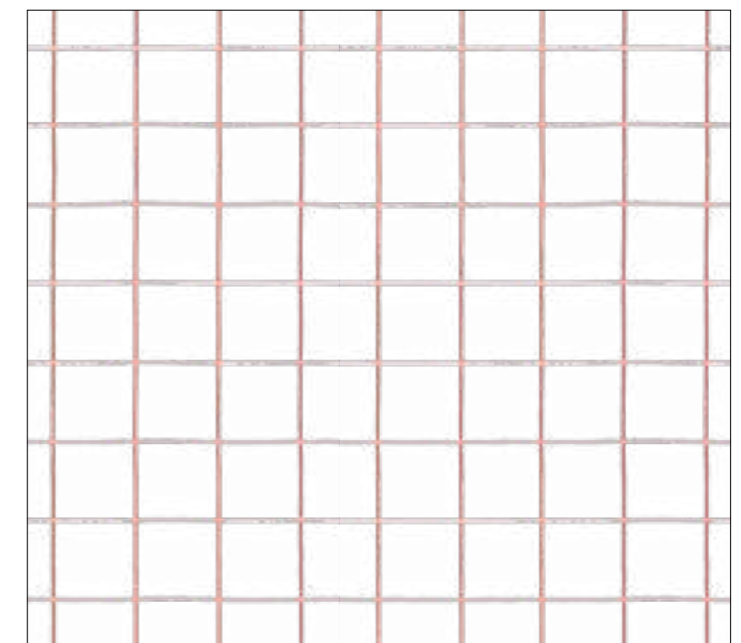

COMPLEMENTI / COMPLEMENTS

SPECCHIERE /
MIRRORS

TRIO

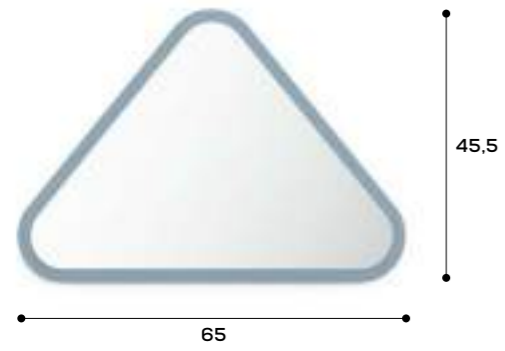

QUADRO

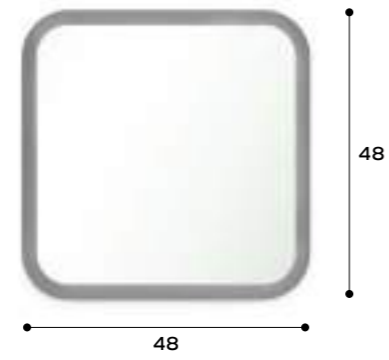

GIRO



WINDOW

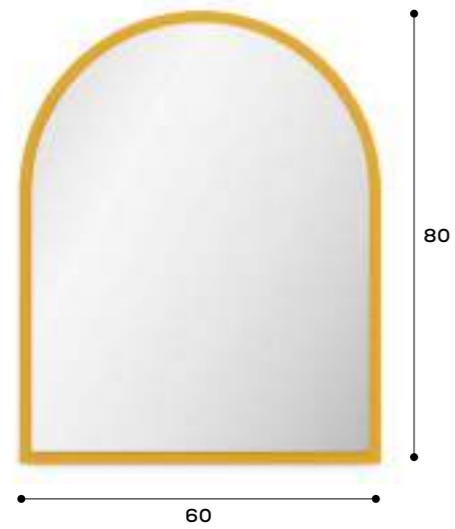

CORNERY

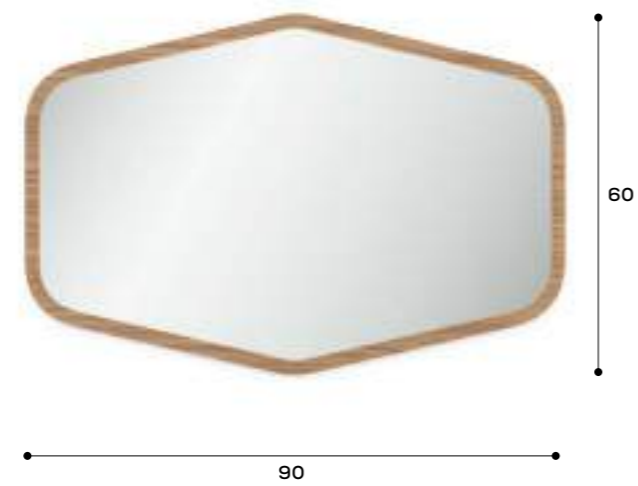

LIBRERIE BOOKCASES

Le librerie offrono soluzioni flessibili e personalizzabili per organizzare gli spazi. Le infinite possibilità di configurazione permettono di scegliere tra diverse misure, finiture e accessori e integrano vani aperti, chiusi o soluzioni a ponte, creando composizioni versatili e funzionali.

Bookcases offer flexible, customizable solutions for organizing spaces. With different sizes, finishes and accessories to choose from, the range of possible configurations is endless, with the option of incorporating open or closed storage or bridging solutions, creating versatile and functional assemblies.

07 LIBRERIE / BOOKCASES



216 Librerie Luce sp. 1,8 cm /
Luce bookcases 1,8 cm thick



226 Librerie Holly sp. 3 cm /
Holly bookcases 3 cm thick



248 Librerie Surfy /
Surfy bookcases



LIBRERIE LUCE SP. 1,8 CM / LUCE BOOKCASES 1,8 CM THICK

Blocco dopo blocco la libreria Luce prende forma... Mai la stessa e sempre diversa. Tante configurazioni: a terra o sospesa, con vani aperti o chiusi, in tutte le finiture a catalogo...e Luce sia!

The Luce bookcase takes shape block by block... No two solutions are ever the same. So many different configurations: floorstanding or wall mounted, with open or closed storage, in any of the finishes from the catalogue... welcome to the wonderful world of Luce!

Fianchi, ripiani, schiene ed ante sono disponibili in tutte le finiture a catalogo, per personalizzare la composizione. / Side panels, shelves, back panels and doors are available in any finish from the catalogue, so you can customize a configuration to suit your needs.

A TERRA / FLOORSTANDING
p. 218

SOSPESA / WALL MOUNTED
p. 222

Luce ha una struttura snella ma funzionale, da abbinare a diverse tipologie di maniglie in base alle esigenze. / Luce has a slim yet functional structure, which can be paired with different types of handles depending on your requirements.

Le ante sono disponibili battenti, a rialza o a ribalta e anche nella versione ribalta con portascarpe per lasciare tutto perfettamente in ordine. Non solo nella versione a terra ma anche sospesa. / You have a choice of hinged, lift-up or drop-down doors, as well as a drop-down version incorporating a shoe rack to keep the room perfectly tidy. In addition to the floorstanding version, there's a wall-mounted option, too.

Fare riferimento al listino per verificare eventuali limitazioni. / Refer to the price list to check for any limitations.

A TERRA / FLOORSTANDING

ALTEZZE / HEIGHTS

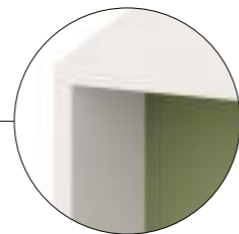
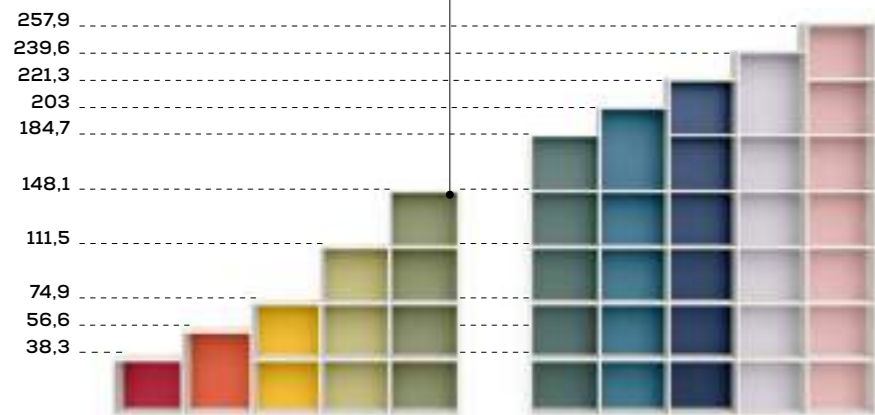

Il top intero sp. 1,8 cm è compreso fino all'altezza 148,1 cm e viene fissato sopra alle spalle laterali. / The 1,8cm-thick one-piece top is included up to a height of 148,1 cm and is fastened on top of the end side panels.

LARGHEZZE E PROFONDITÀ / WIDTHS AND DEPTH

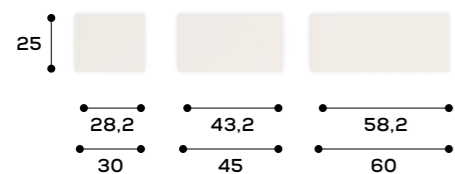

COMPONENTI / COMPONENTS



- 01 anta battente / hinged door
sp. 2,2 cm / 2,2 cm thick
- 02 anta rialza / lift-up door
sp. 2,2 cm / 2,2 cm thick
- 03 anta ribalta / pull-down door
sp. 2,2 cm / 2,2 cm thick
- 04 anta ribalta con portascarpe /
pull-down door with shoe rack
sp. 2,2 cm / 2,2 cm thick
- 05 ripiano interno / internal shelf
sp. 1,8 cm, profondità 20,6 cm /
1,8 cm thick, 20,6 cm deep
- 06 ripiano esterno / external shelf
sp. 1,8 cm, profondità 23,2 cm /
1,8 cm thick, 23,2 cm deep



LIBRERIE LUCE SP. 1,8 CM / LUCE BOOKCASES 1,8 CM THICK

A TERRA / FLOORSTANDING



LIBRERIE LUCE SP. 1,8 CM / LUCE BOOKCASES 1,8 CM THICK

SOSPESA /
WALL MOUNTED

ALTEZZE / HEIGHTS

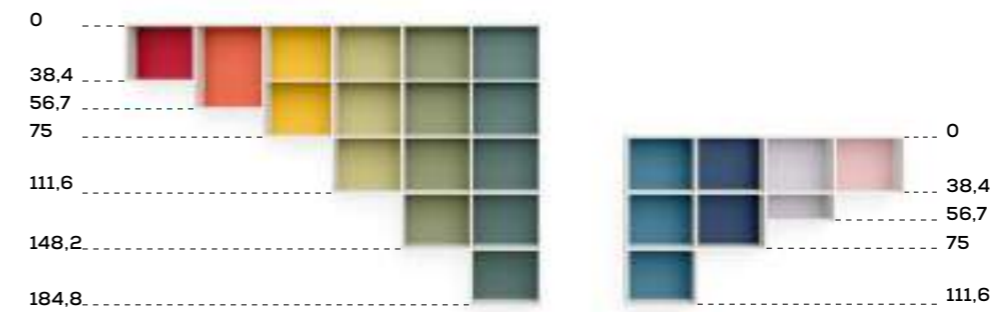

Librerie sospese con cappello /
Wall-mounted bookcases with top cover

Librerie sospese con top intero /
Wall-mounted bookcases with one-piece top

LARGHEZZE E PROFONDITÀ / WIDTHS AND DEPTH

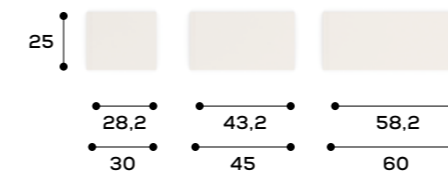
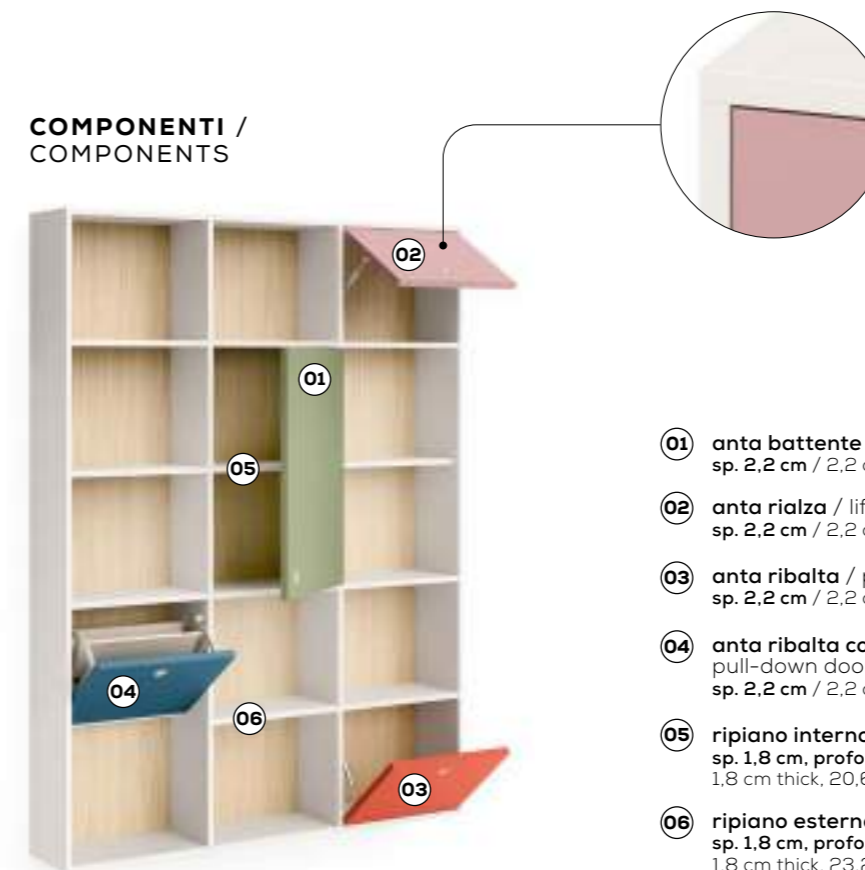
COMPONENTI /
COMPONENTS

- 01 anta battente / hinged door
sp. 2,2 cm / 2,2 cm thick
- 02 anta rialza / lift-up door
sp. 2,2 cm / 2,2 cm thick
- 03 anta ribalta / pull-down door
sp. 2,2 cm / 2,2 cm thick
- 04 anta ribalta con portascarpe /
pull-down door with shoe rack
sp. 2,2 cm / 2,2 cm thick
- 05 ripiano interno / internal shelf
sp. 1,8 cm, profondità 20,6 cm /
1,8 cm thick, 20,6 cm deep
- 06 ripiano esterno / external shelf
sp. 1,8 cm, profondità 23,2 cm /
1,8 cm thick, 23,2 cm deep

LIBRERIE LUCE SP. 1,8 CM / LUCE BOOKCASES 1,8 CM THICK

SOSPESA /
WALL MOUNTED



LIBRERIE HOLLY SP. 3 CM / HOLLY BOOKCASES 3 CM THICK

A terra, sospesa o a ponte, bifacciale o passante, con vani a giorno o chiusi da ante e cassetti. Con la libreria Holly, la creatività ha tutto lo spazio che merita!

Standing on the floor, wall mounted or bridging, double-sided or open-back, with open shelving or storage behind doors and drawers. With the Holly bookcase, creativity has all the space it deserves!

**A PONTE /
BRIDGING**
p. 230

**A TERRA /
FLOORSTANDING**
p. 228

L'anta battente Soft, imbottita e sfoderabile, è disponibile in tutti i tessuti. /
The Soft hinged door, which is padded and has a removable cover, is available in all fabrics.

**SOSPESA /
WALL MOUNTED**
p. 242

I ripiani portascarpe sono il giusto alleato per mantenere l'ordine in tutta la camera. /
Shoe rack shelves are just the tool you need to keep the whole room tidy.

Fianchi, ripiani e schiene sono disponibili in tutte le finiture a catalogo anche a contrasto tra loro. /
Side panels, shelves and back panels are available in any finish from the catalogue, and you can even mix contrasting colours.



Ante battenti, a ribalta o rialza, cassetti: diverse conformazioni per diverse necessità. /
Hinged, pull-down or lift-up doors, and drawers: different configurations for different needs.

La libreria sospesa è disponibile sia nella versione con schiena che senza. /
The wall-mounted bookcase is available in both an open-back version and with a back panel.

Lo scrittoio a ribalta permette di creare un comodo angolo studio. /
The drop-down desk can be used to create a handy study nook.

**LETTO A RIBALTA TWIDDY /
TWIDDY DROP-DOWN BED**
p. 108

La libreria con letto a ribalta Twiddy è un'ottima soluzione salvaspazio. /
The bookcase with Twiddy drop-down bed makes an excellent space-saving solution.

Fare riferimento al listino per verificare eventuali limitazioni. /
Refer to the price list to check for any limitations.

LIBRERIE HOLLY SP. 3 CM / HOLLY BOOKCASES 3 CM THICK

A TERRA /
FLOORSTANDING

ALTEZZE / HEIGHTS

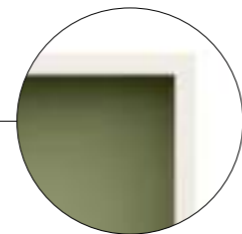
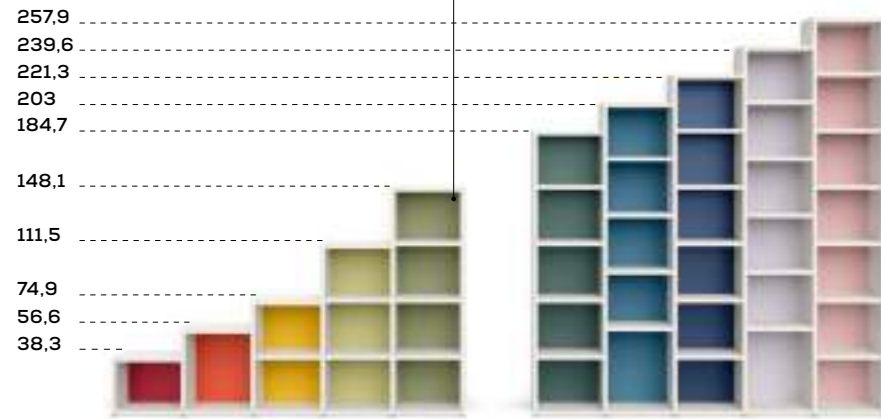

Il top intero sp. 3 cm è compreso fino all'altezza 148,1 cm e viene fissato sopra alle spalle laterali. / The 3cm-thick one-piece top is included up to a height of 148,1 cm and is fastened on top of the end side panels.

LARGHEZZE E PROFONDITÀ / WIDTHS AND DEPTHS

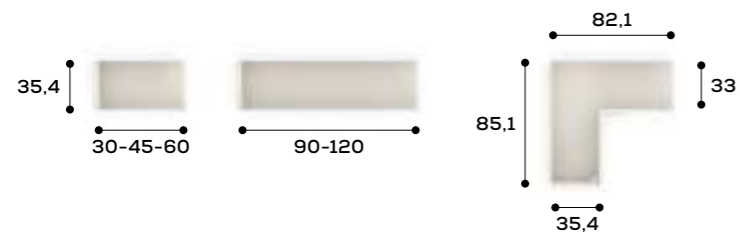

TERMINALI / END UNITS

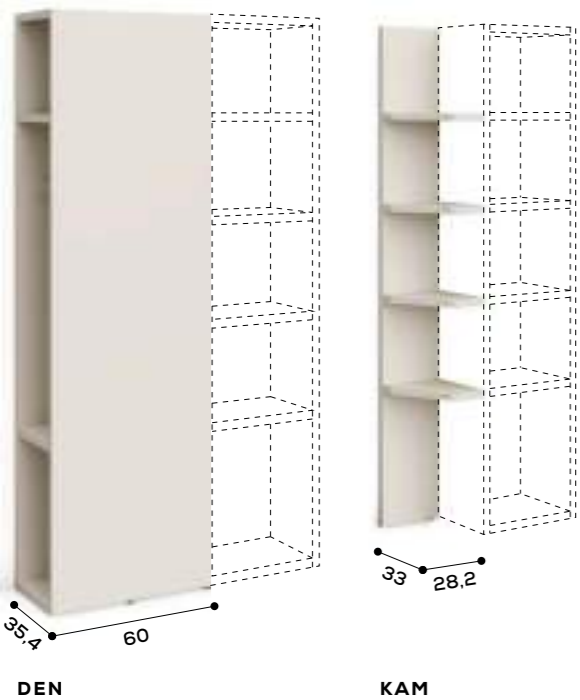

LIBRERIE HOLLY SP. 3 CM / HOLLY BOOKCASES 3 CM THICK

A PONTE /
BRIDGING

ALTEZZE / HEIGHTS

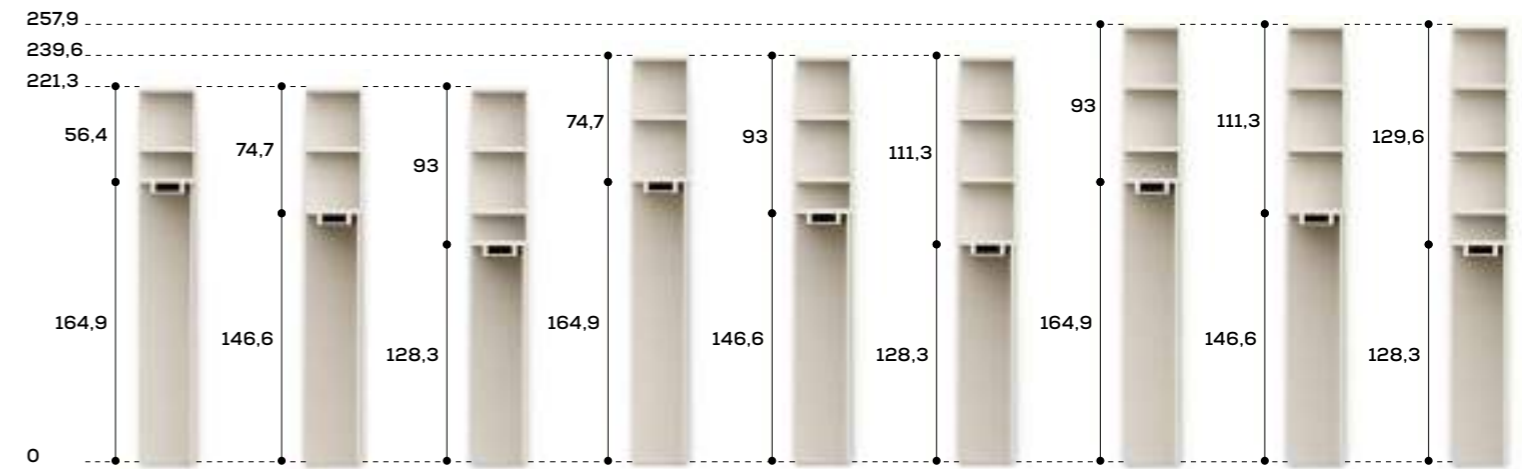

LARGHEZZE E PROFONDITÀ / WIDTHS AND DEPTH

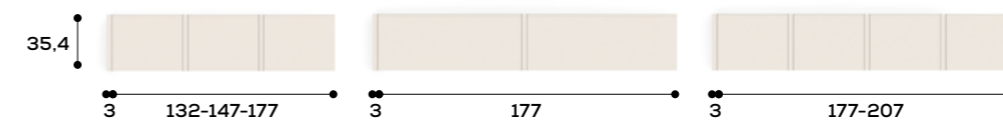

LIBRERIE HOLLY SP. 3 CM / HOLLY BOOKCASES 3 CM THICK

SCRITTOIO A RIBALTA / DROP-DOWN DESK



Guarda come si apre
lo scrittoio. /
Watch how the desk
folds open.

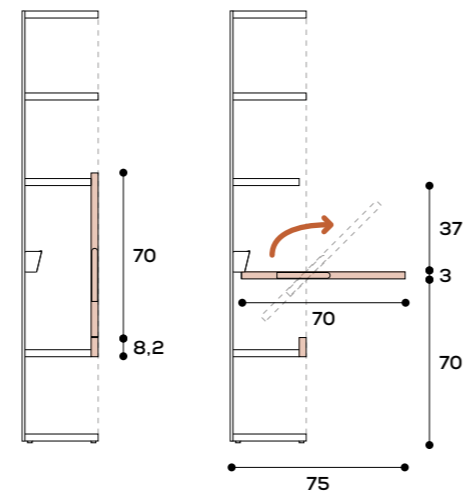

COMPONENTI / COMPONENTS



- 01 anta battente / hinged door
sp. 2,2 cm / 2,2 cm thick
- 02 anta rialza / lift-up door
sp. 2,2 cm / 2,2 cm thick
- 03 anta ribalta / pull-down door
sp. 2,2 cm / 2,2 cm thick
- 04 anta ribalta / pull-down door
sp. 2,2 cm / 2,2 cm thick
- 05 cassetti / drawers
sp. 2,2 cm / 2,2 cm thick
- 06 cassettone / oversized drawer
sp. 2,2 cm / 2,2 cm thick
- 07 ripiano portascarpe / shoe rack shelf
sp. 1,2 cm / 1,2 cm thick
- 08 ripiano per libreria con schiena /
shelf for bookcase with back panel
sp. 3 cm, profondità 31,3 cm /
3 cm thick, 31,3 cm deep
- 09 ripiano per libreria senza schiena /
shelf for bookcase with no back panel
sp. 3 cm, profondità 32,8 cm /
3 cm thick, 32,8 cm deep



LIBRERIE HOLLY SP. 3 CM / HOLLY BOOKCASES 3 CM THICK

A TERRA / FLOORSTANDING



LIBRERIE HOLLY SP. 3 CM / HOLLY BOOKCASES 3 CM THICK

COMPONENTI /
COMPONENTS

ante Soft imbottite /
padded Soft doors
sp. 5 cm / 5 cm thick

ante Soft imbottite per vani a terra /
padded Soft doors for floor-level shelves
sp. 5 cm / 5 cm thick

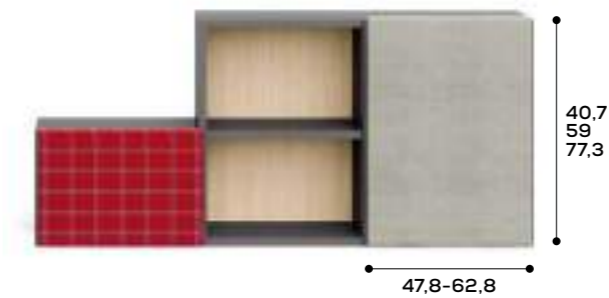
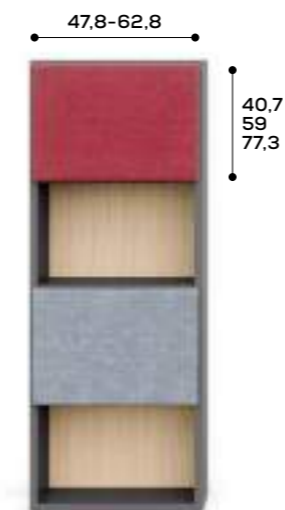

Le ante imbottite sono disponibili in tutti i tessuti e sfoderabili. /
Padded doors are available in all fabrics and have removable covers.

LIBRERIE HOLLY SP. 3 CM / HOLLY BOOKCASES 3 CM THICK

A TERRA / FLOORSTANDING



SOSPESA / WALL MOUNTED

ALTEZZE / HEIGHTS

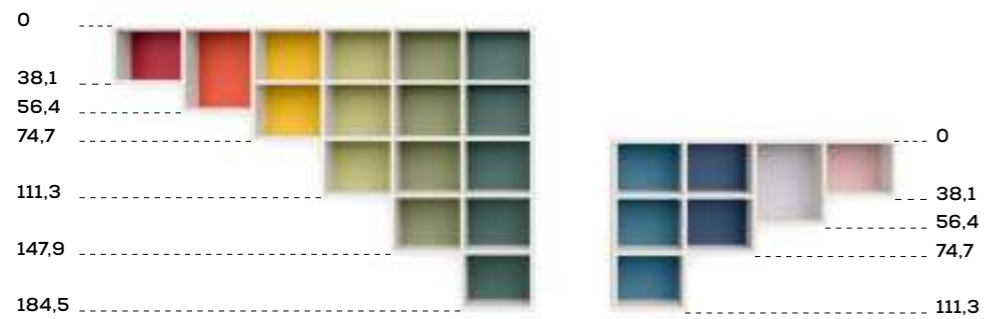

Librerie sospese con cappello /
Wall-mounted bookcases with top cover

Librerie sospese con top intero /
Wall-mounted bookcases with one-piece top

LARGHEZZE E PROFONDITÀ / WIDTHS AND DEPTH



COMPONENTI / COMPONENTS

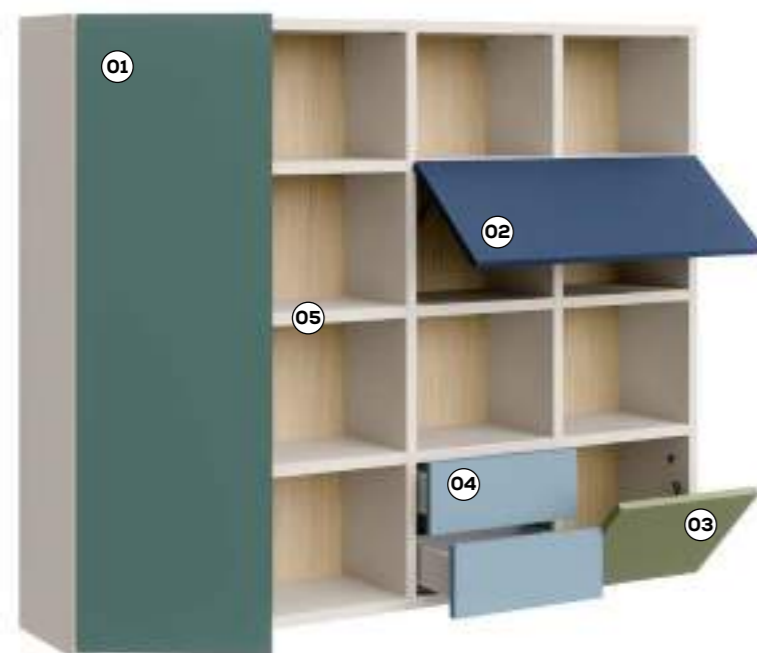

- 01 anta battente / hinged door
sp. 2,2 cm / 2,2 cm thick
- 02 anta rialza / lift-up door
sp. 2,2 cm / 2,2 cm thick
- 03 anta ribalta / pull-down door
sp. 2,2 cm / 2,2 cm thick
- 04 cassetti / drawers
sp. 2,2 cm / 2,2 cm thick
- 05 ripiano per libreria con schiena /
shelf for bookcase with back panel
sp. 3 cm, profondità 31,3 cm /
3 cm thick, 31,3 cm deep

Sono disponibili anche ripiani per libreria senza schiena: vedi pag. 234. /
Shelves are also available shelf for bookcase with back panel: see page 234.



LIBRERIE HOLLY SP. 3 CM / HOLLY BOOKCASES 3 CM THICK

**SOSPESA /
WALL MOUNTED**



LIBRERIE HOLLY SP. 3 CM / HOLLY BOOKCASES 3 CM THICK

SOSPESA /
WALL MOUNTED



LIBRERIE SURFY / SURFY BOOKCASES



La libreria Surfy è disponibile con fianchi dritti o curvi e nella versione con o senza specchio. Questo elemento freestanding offre spazio per libri, oggetti e decorazioni, fungendo anche da divisorio tra l'angolo studio e la zona notte all'interno della cameretta.

The Surfy bookcase comes with straight or curved side panels and in versions with or without a mirror. This freestanding item provides space for books, ornaments and belongings in general, while also serving as a divider between the bedroom's study nook and sleep zone.

**LIBRERIA SURFY VERTICALE /
VERTICAL SURFY BOOKCASE**



Disponibile con fianco dritto o curvo, con o senza specchio. /
Comes with straight or curved side panel, with or without a mirror.



LIBRERIE SURFY / SURFY BOOKCASES

LIBRERIA SURFY ORIZZONTALE /
HORIZONTAL SURFY BOOKCASE

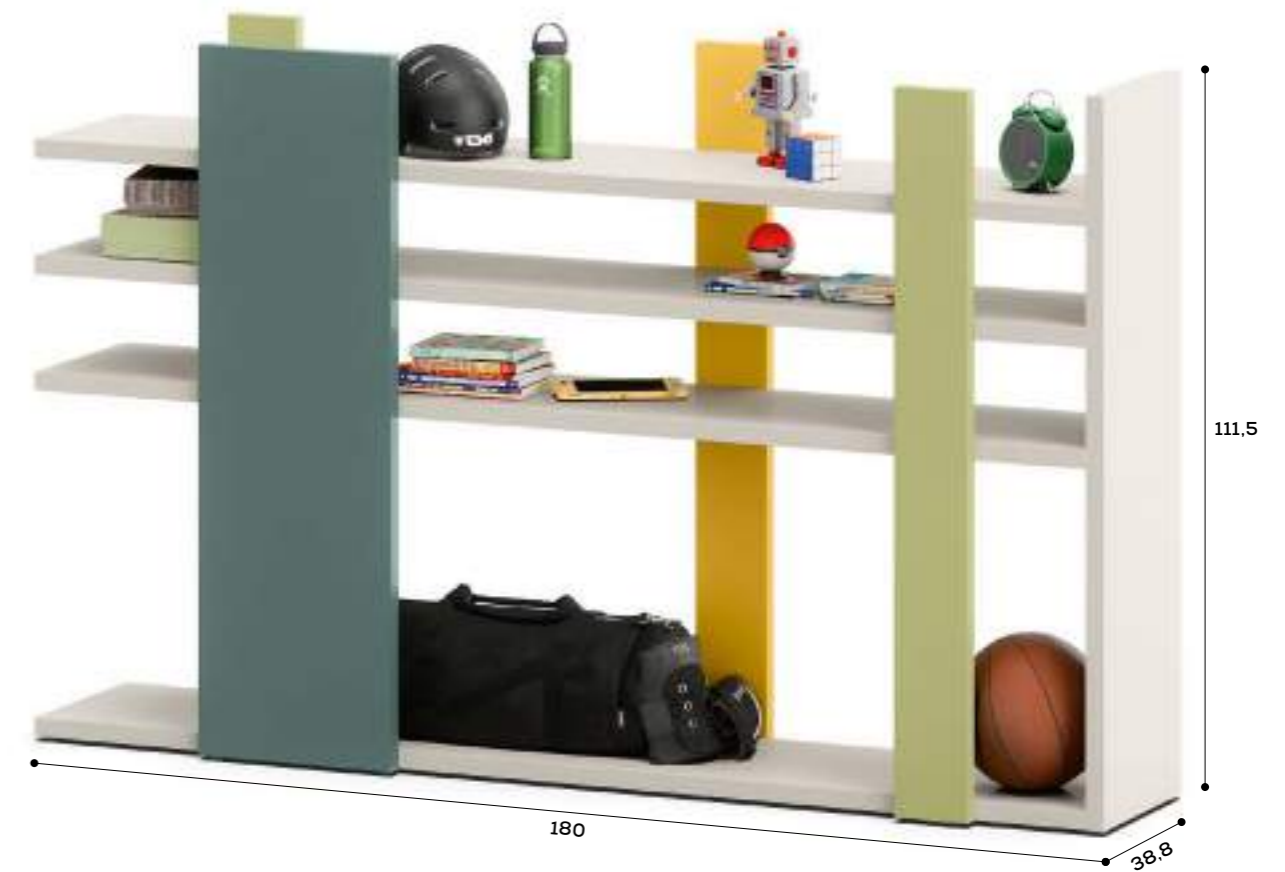
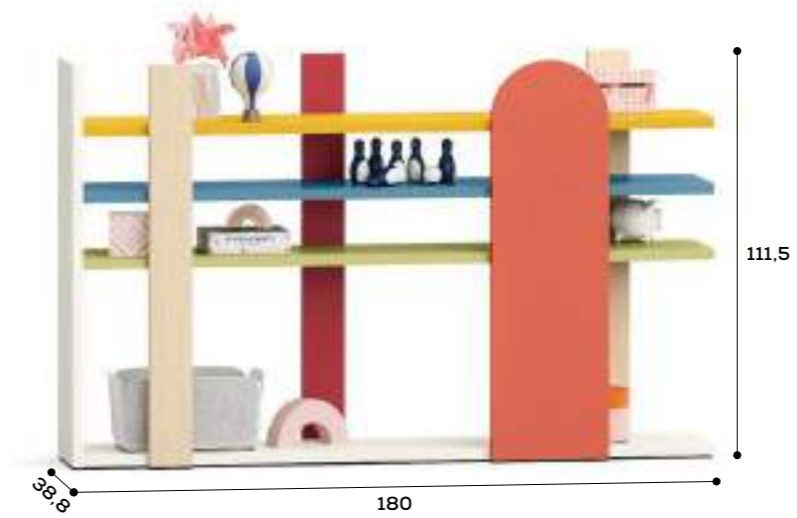

Disponibile con fianco dritto o curvo. /
Comes with straight or curved side panel.

MENSOLE E CASELLARI SHELVES AND WALL UNITS

Le mensole e i casellari sono progettati per aggiungere praticità e funzionalità alla camera da letto. Disponibili in varie dimensioni e colori, si integrano perfettamente con gli altri arredi della collezione o possono essere utilizzati come elementi decorativi.

Shelves and wall units are designed to bring practicality and functionality into the bedroom. Available in various sizes and colours, they go perfectly with the other furniture in the collection or can be used as decorative features.

08 MENSOLE E CASELLARI / SHELVES AND WALL UNITS



256 **Mensole sp. 3 - 5 cm /**
Shelves 3 - 5 cm thick



258 **Mensole Hook /**
Hook shelves



258 **Mensole Poppy /**
Poppy shelves



260 **Casellari Lippy /**
Lippy wall units



260 **Casellari Cloud /**
Cloud wall units



261 **Mensola Kam /**
Kam shelf



262 **Casellari Luce /**
Luce wall units



264 **Casellari Tynn /**
Tynn wall units



266 **Casellari Boxy /**
Boxy wall units



267 **Casellari Pitagora /**
Pitagora wall units

**MENSOLE SP. 3 - 5 CM /
SHELVES 3 - 5 CM THICK**



**SUPPORTI DISPONIBILI /
CHOICE OF SUPPORTS**

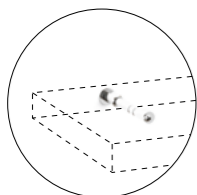

Freccia
Supporto a scomparsa regolabile. /
Adjustable hidden support.

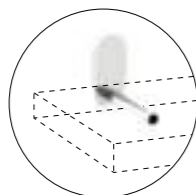

Arco
Supporto a semi scomparsa regolabile. /
Semi-hidden, adjustable support.

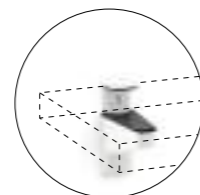

Morsetto

Possono essere dotate di lampada LED ad incasso. /
Can be fitted with recessed LED light.



MENSOLE E CASELLARI / SHELVES AND WALL UNITS

MENSOLE HOOK /
HOOK SHELVES

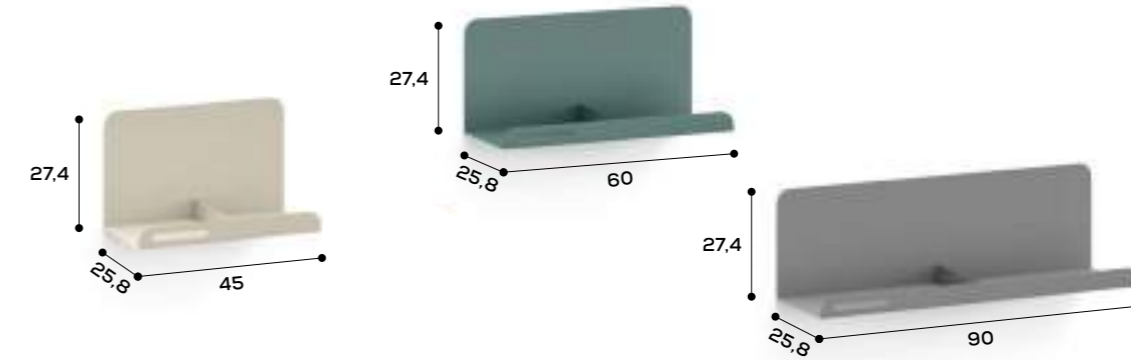

In metallo sp. 0,2 cm. /
Made from metal, 0,2 cm thick.

MENSOLE POPPY /
POPPY SHELVES

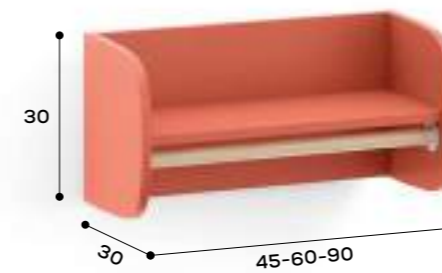

Sp. 1,8 cm. / 1,8 cm thick.

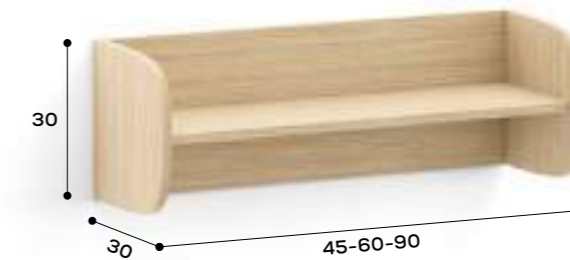

APPENDIABILI DISPONIBILI /
HANGING OPTIONS

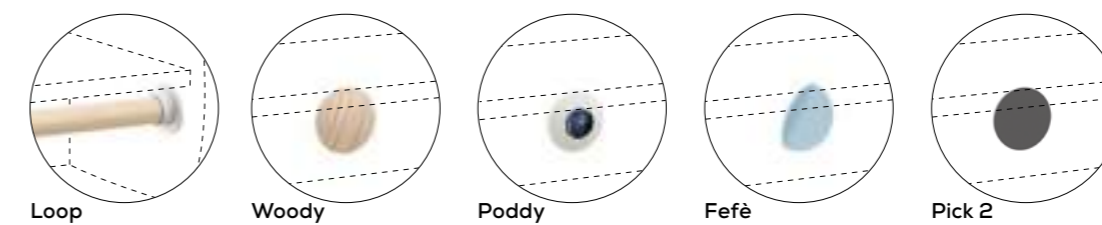

MENSOLE E CASELLARI / SHELVES AND WALL UNITS

CASELLARI LIPPY /
LIPPY WALL UNITS

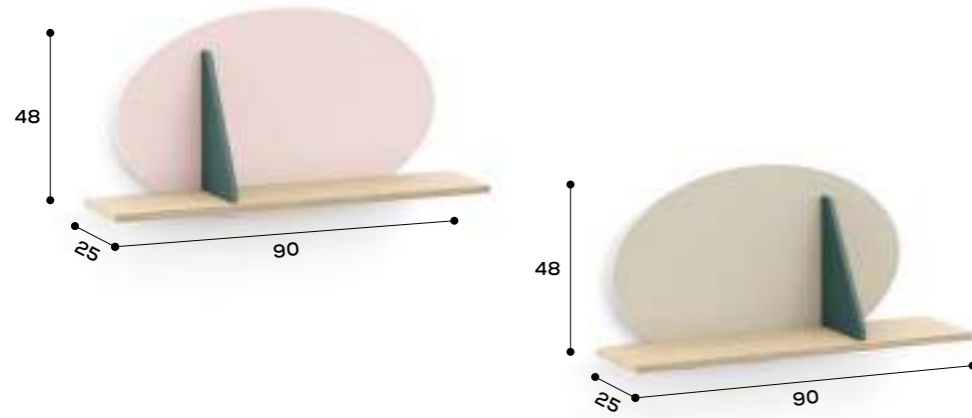

Struttura sp. 1,8 cm e tramezza sp. 1,2 cm.
Disponibili nella versione dx e sx. /
Structure 1,8 cm thick and partitions 1,2 cm thick.
Come in RH and LH version.

CASELLARI CLOUD /
CLOUD WALL UNITS

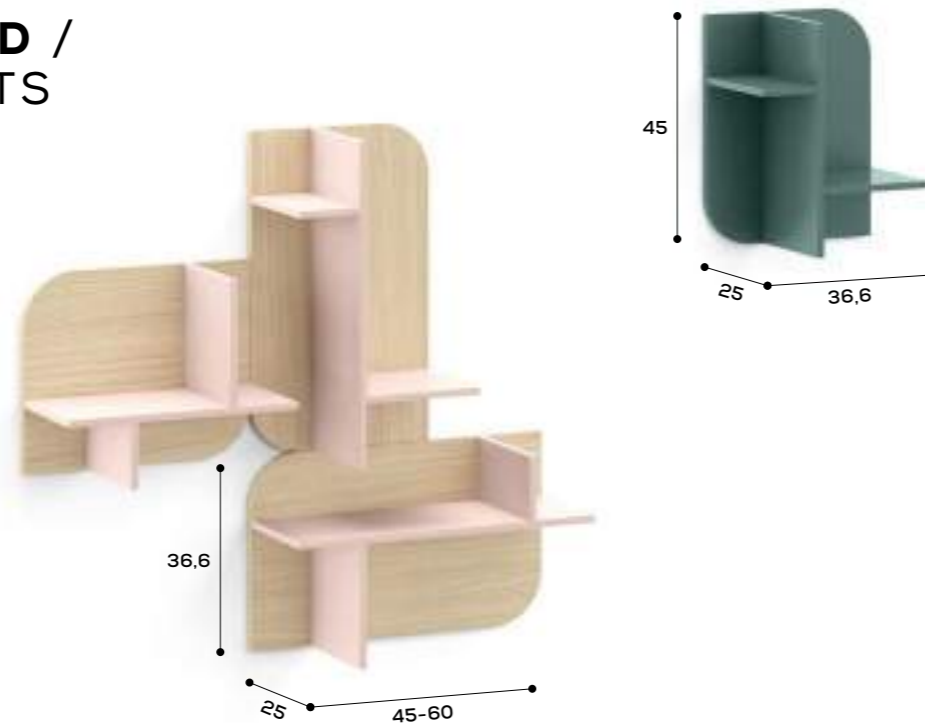

Struttura sp. 1,8 cm e tramezze sp. 1,2 cm.
Disponibili nella versione dx e sx. /
Structure 1,8 cm thick and partitions 1,2 cm thick.
Come in RH and LH version.

MENSOLA KAM /
KAM SHELF

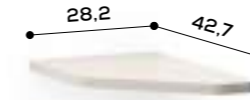

Sp. 3 cm. Uso comodo per interno fianco sostegno ponte.
Da utilizzare solo per ponti con schienale sottoponte. /
3 cm thick. Use as bedside table for inside bridging unit supporting side panel.
For use only on bridging units with back panel underneath.



MENSOLE E CASELLARI / SHELVES AND WALL UNITS

CASELLARI LUCE /
LUCE WALL UNITS



Struttura sp. 1,8 cm. Disponibili nella versione dx o sx, con e senza ante. /
Structure 1,8 cm thick. Come in RH or LH version, with or without doors.



MENSOLE E CASELLARI / SHELVES AND WALL UNITS

CASELLARI TYNN /
TYNN WALL UNITS

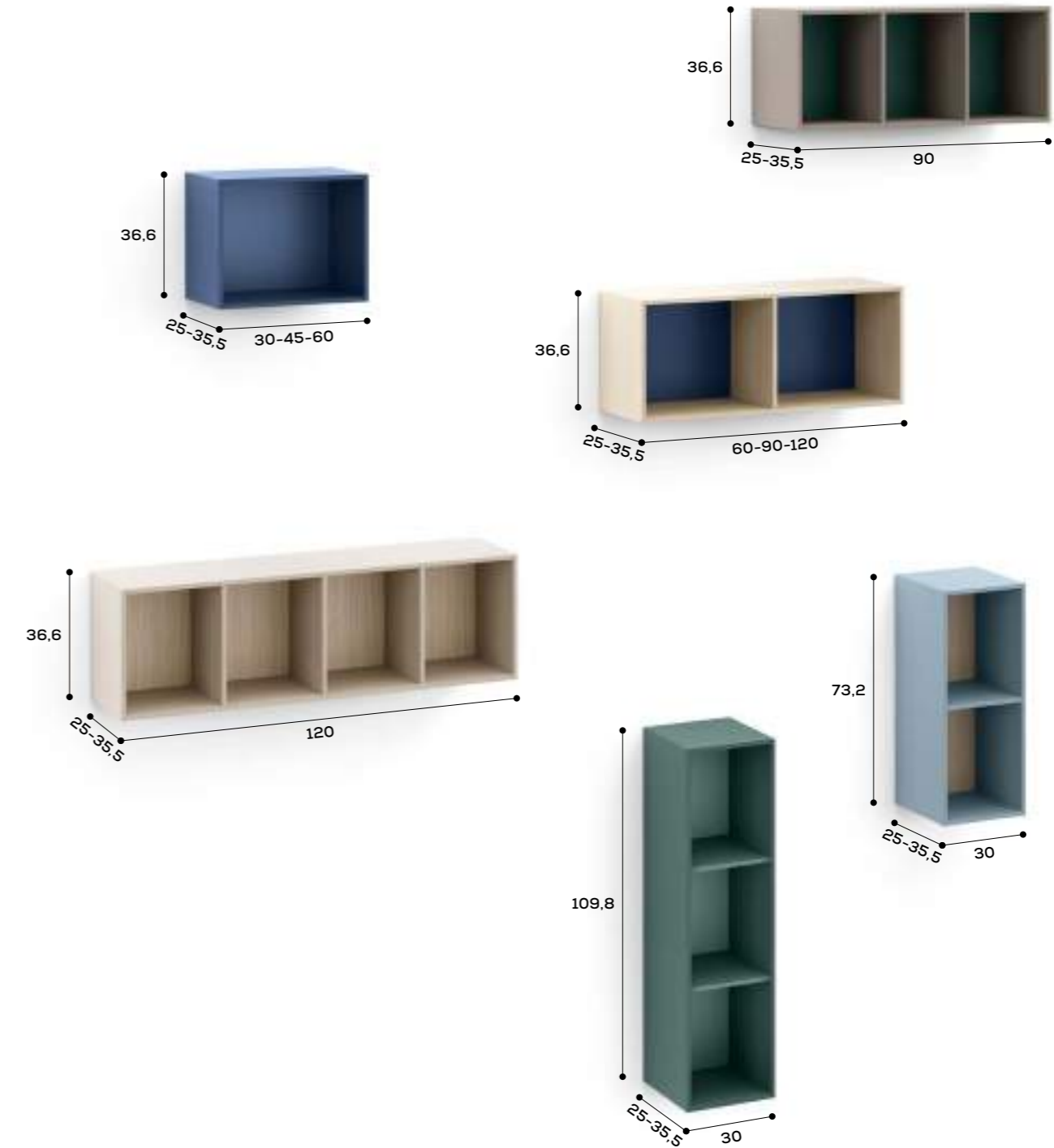

Struttura sp. 1,2 cm. / Structure 1.2 cm thick.

MENSOLE E CASELLARI / SHELVES AND WALL UNITS

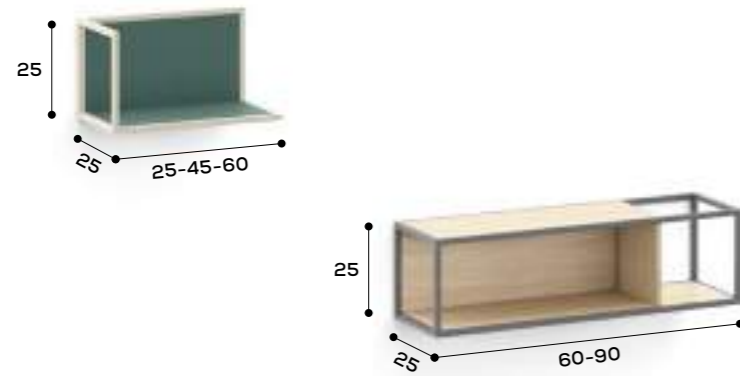
CASELLARI BOXY /
BOXY WALL UNITS

Struttura metallica con pannello sp. 1,2 cm. Disponibili nella versione dx e sx. /
Metal structure with panel 1,2 cm thick. Come in RH and LH version.

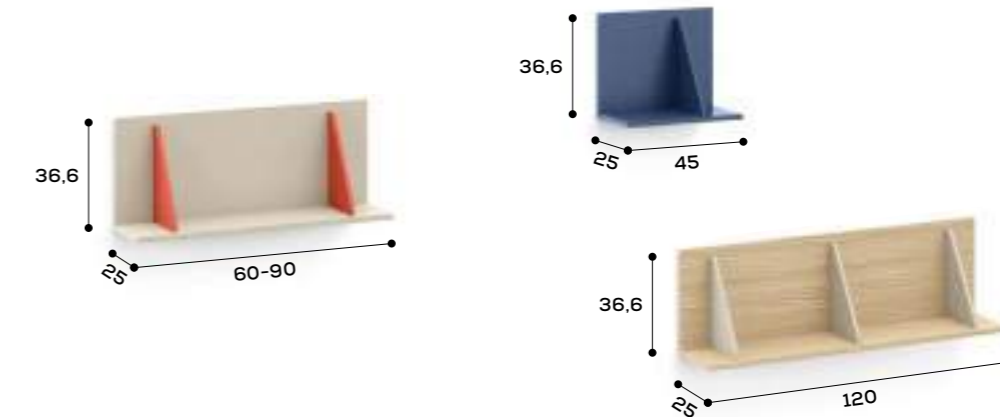
CASELLARI PITAGORA /
PITAGORA WALL UNITS

Struttura sp. 1,8 cm e tramezze sp. 1,2 cm. /
Structure 1,8 cm thick and partitions 1,2 cm thick.

SISTEMA LOOP LOOP SYSTEM

Il sistema Loop è una soluzione modulare versatile composta con pali in legno, pensata per creare composizioni a parete su misura. Con gli elementi free-standing e accessori personalizzabili, è possibile progettare ambienti funzionali e ordinati, adatti a spazi di studio o relax. Il sistema Loop si distingue per la sua semplicità e la facilità di integrazione con altri complementi Nidi.

The Loop system is a versatile modular solution comprising wooden rods, designed for creating custom wall-mounted configurations. With a combination of customizable freestanding items and accessories, you can design functional, clutter-taming interior solutions, perfect for study or chill-out spaces. The Loop system stands out for its simplicity and its seamless integration with other Nidi complements.

09 SISTEMA LOOP / LOOP SYSTEM



270 Componenti /
Components



278 Elementi free-standing /
Freestanding items

SISTEMA LOOP / LOOP SYSTEM





COMPONENTI / COMPONENTS

PALI SINGOLI / SINGLE RODS

In finitura legno naturale. / In legno naturale finish.



RACCORDI / CONNECTORS

Disponibili bianco e lavagna. / Come in bianco and lavagna finish.

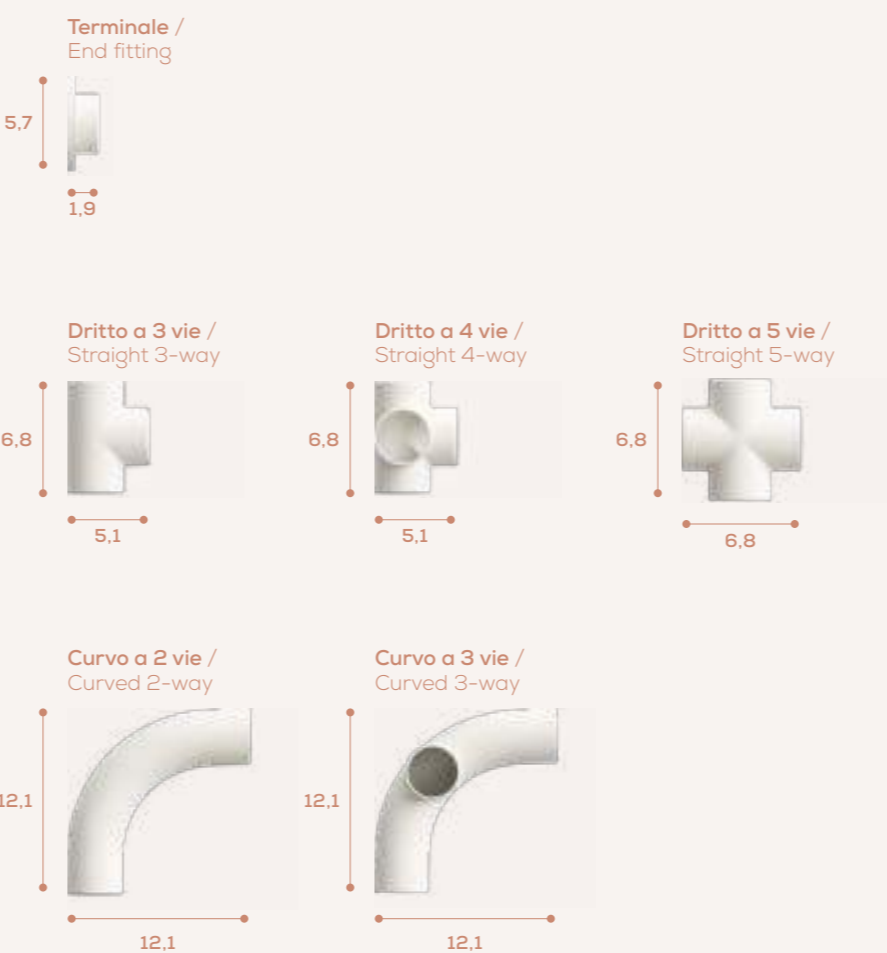

ACCESSORI / ACCESSORIES



SISTEMA LOOP / LOOP SYSTEM

COMPONENTI /
COMPONENTS



SISTEMA LOOP / LOOP SYSTEM

ACCESSORI /
ACCESSORIES

CESTINO BOX /
TIDY BOX

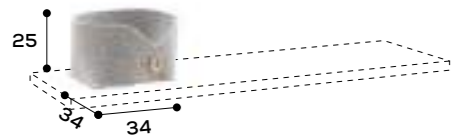

BORSA PORTAOGGETTI /
HANGING BAG ORGANIZER

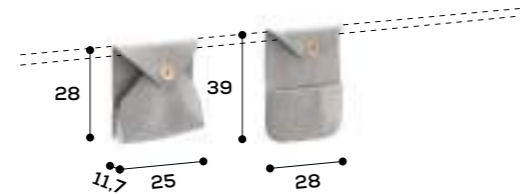

MULTITASCA PORTAOGGETTI /
MULTI-POCKET ORGANIZER

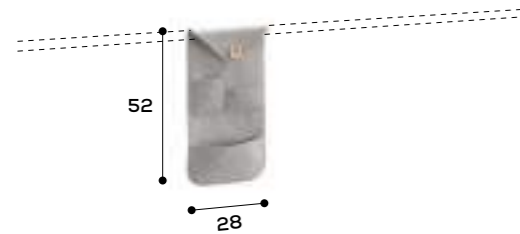

GANCIO APPENDIABITO /
COAT HOOK

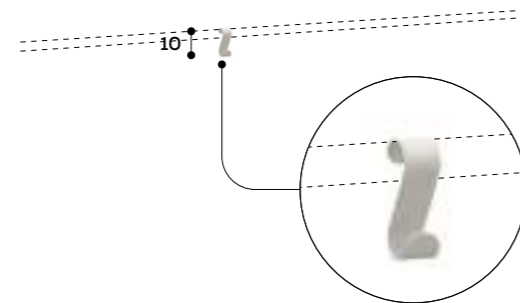

STAFFA PORTA-TV ORIENTABILE /
TILT AND TURN TV MOUNTING BRACKET

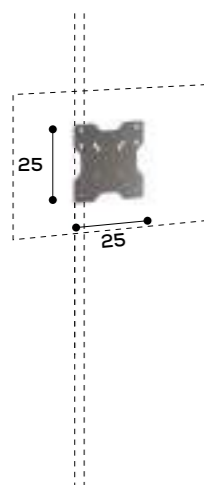

SPECCHIO ORIENTABILE /
REVOLVING MIRROR

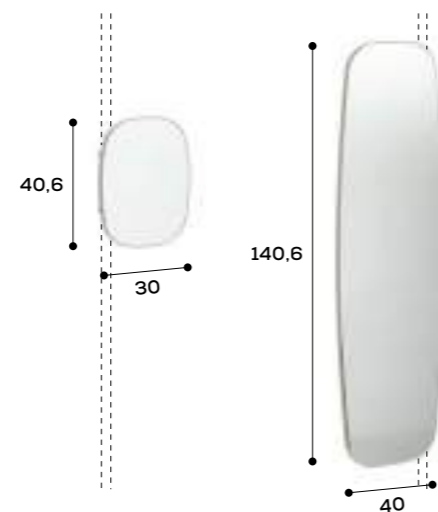

ELEMENTI FREE-STANDING / FREESTANDING ITEMS

SCRITTOIO LOOP /
LOOP DESK



SISTEMA LOOP / LOOP SYSTEM

ELEMENTI FREE-STANDING /
FREESTANDING ITEMS



PANCA LOOP /
LOOP BENCH



PANCA LOOP CON ANTA /
LOOP BENCH WITH DOOR

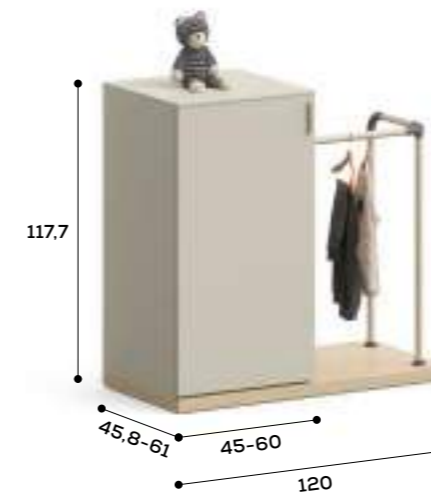

PANCA LOOP CON CASSETTI /
LOOP BENCH WITH DRAWERS

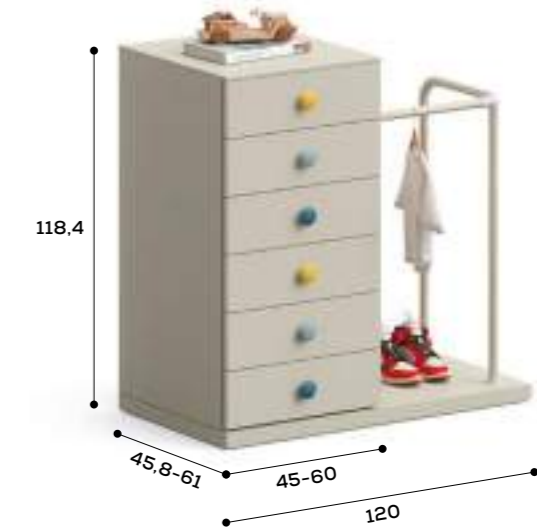

PANCA LOOP CON LIBRERIA /
LOOP BENCH WITH BOOKCASE

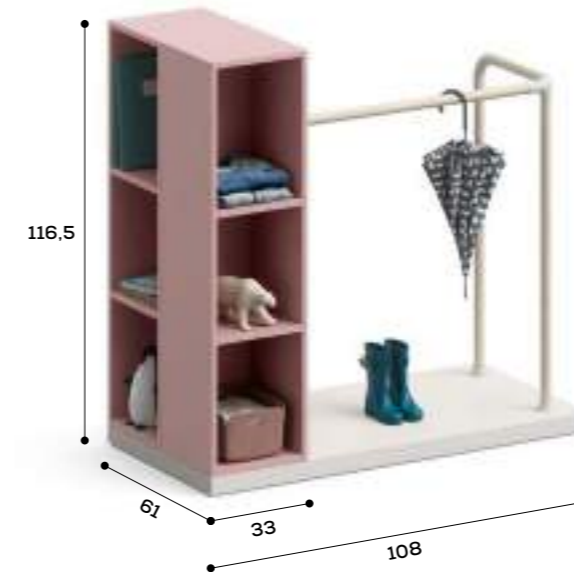

BOISERIE WALL PANELLING

Le boiserie sono disponibili in diverse versioni, e rappresentano un'ottima soluzione per trasformare la parete in un accessorio irrinunciabile nella camera. Disponibile in diverse finiture e dimensioni, la boiserie può essere arricchita con mensole o casellari per una maggiore funzionalità. Wally, Becky o Dots...a te la scelta!

Wall panelling comes in a range of versions and is an excellent solution for turning bedroom walls into a must-have accessory. Available in different finishes and sizes, wall panelling can be complemented with shelves or wall units for extra functionality. Wally, Becky or Dots...the choice is yours!

10 BOISERIE / WALL PANELLING



286 Boiserie Wally /
Wally wall panelling



292 Boiserie Becky /
Becky wall panelling



300 Boiserie Dots /
Dots wall panelling

BOISERIE / WALL PANELLING

**BOISERIE BECKY /
BECKY WALL PANELLING**
P. 292

Disponibile anche nella versione imbottita
in tutti i tessuti e sfoderabile. /
It also comes in a padded version with
removable covers in any fabric.

**BOISERIE WALLY /
WALLY WALL PANELLING**
p. 286

Con il taglio a mansarda, arredare gli spazi più
difficili è un gioco da ragazzi! /
With the option of cutting panels to
accommodate a sloping ceiling, fitting out even
the trickiest spaces is child's play!



I pannelli forati Dots in finitura legno
naturale sono accessoriabili con
mensole, ganci, specchio e porta oggetti. /
Dots pegboards in the legno naturale
finish can be accessorized with shelves,
hooks, mirrors and tidy trays.

Le boiserie Becky e Dots possono
essere combinate tra loro per una
soluzione pratica e originale. /
Becky and Dots wall panelling can
be used together for a practical and
original solution.

**BOISERIE DOTS /
DOTS WALL PANELLING**
p. 300

La boiserie Wally a muro è
attrezzabile con mensole,
appendiabiti e piani d'appoggio. /
Wally wall panelling can be fitted
with shelves, hanging rails and
floating shelves.

La boiserie è un elemento trasversale che si
adatta ad ogni esigenza: con i giusti accessori,
diventa un angolo studio pratico e funzionale. /
Wall panelling is a cross-functional item
that caters to every requirement: with the
right accessories, it becomes a practical and
functional study nook.

Fare riferimento al listino per verificare eventuali limitazioni. /
Refer to the price list to check for any limitations.

**BOISERIE WALLY /
WALLY WALL PANELLING**

ALTEZZE E LARGHEZZE / HEIGHTS AND WIDTHS

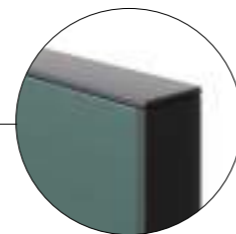
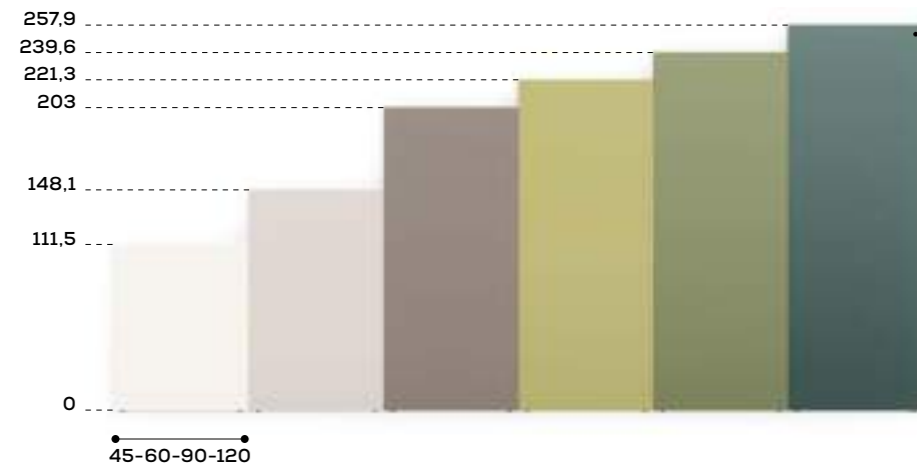

Profilo di chiusura del pannello in finitura bianco o lavagna. / Panel finishing trim in bianco or lavagna finish.

Altezza comprensiva di piedino regolabile. Pannello sp. 1,8 cm, con attaccaglie sp. 3,3 cm. / Height includes adjustable foot. Panel 1,8 cm thick, with 3,3cm-thick hanging brackets.



BOISERIE / WALL PANELLING

BOISERIE WALLY /
WALLY WALL PANELLING

MENSOLE /
SHELVES

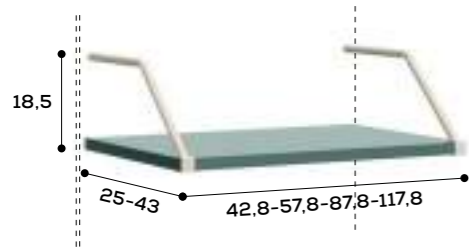

MENSOLE CON TUBO APPENDIABITI /
SHELVES WITH HANGING RAIL

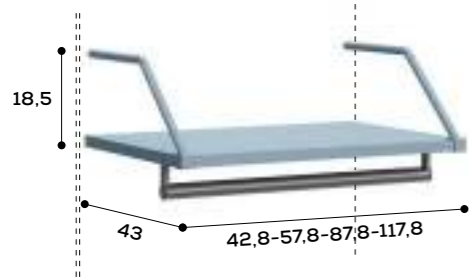

APPENDIABITI /
HANGING RAIL

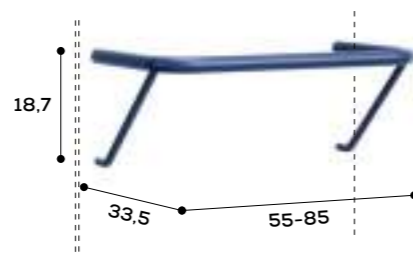

PIANO D'APPOGGIO SOSPESO /
FLOATING SHELF



Piano d'appoggio disponibile sia in versione dritta che sagomata. /
Floating shelf comes in both straight and shaped versions.



BOISERIE / WALL PANELLING

BOISERIE WALLY /
WALLY WALL PANELLING

MENSOLE CON DIVISORI /
SHELVES WITH PARTITIONS

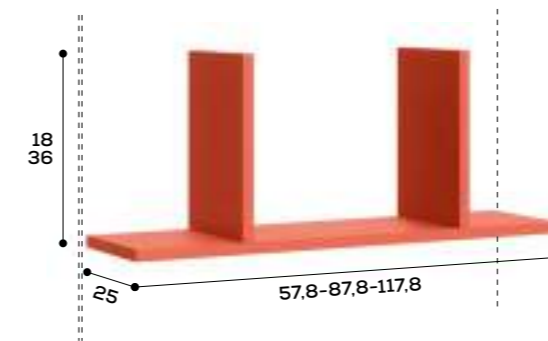

MENSOLE CON SUPPORTI /
SHELVES WITH SUPPORTS

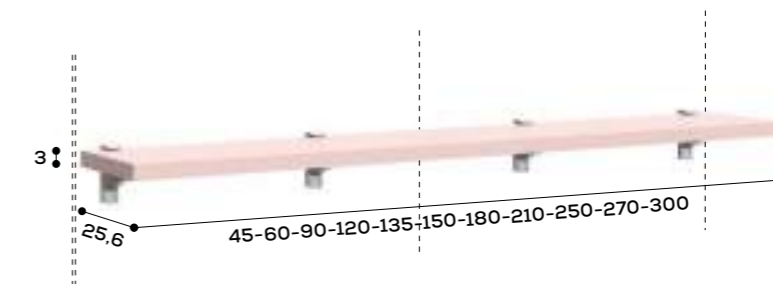
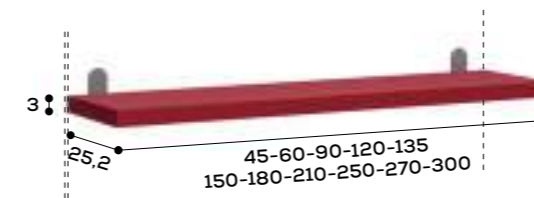

SUPPORTI DISPONIBILI /
CHOICE OF SUPPORTS

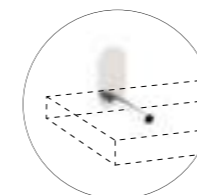

Arco

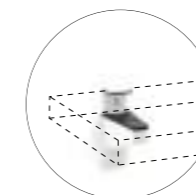

Morsetto



BOISERIE BECKY / BECKY WALL PANELLING

ALTEZZE E LARGHEZZE / HEIGHTS AND WIDTHS



Pannello in nobilitato sp. 2,2 cm. /
Foil-wrapped panel 2,2 cm thick.

ALTEZZE E LARGHEZZE / HEIGHTS AND WIDTHS



Pannello imbottito sp. 2,2 e 4 cm sfoderabile. /
Padded panel 2,2 and 4 cm thick with removable cover.

ILLUMINAZIONE A LED / LED LIGHTING

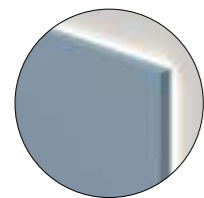

Retroilluminazione
a LED /
LED backlighting



LED direzionale con
interruttore touch e
dimmer /
Directional LED with
touch-sensitive ON/OFF
control and dimmer



Lampada snodabile /
Adjustable lamp



BOISERIE / WALL PANELLING

BOISERIE BECKY /
BECKY WALL PANELLING



BOISERIE / WALL PANELLING

ACCESSORI /
ACCESSORIES

TAVOLINI LABY /
LABY SIDE TABLES

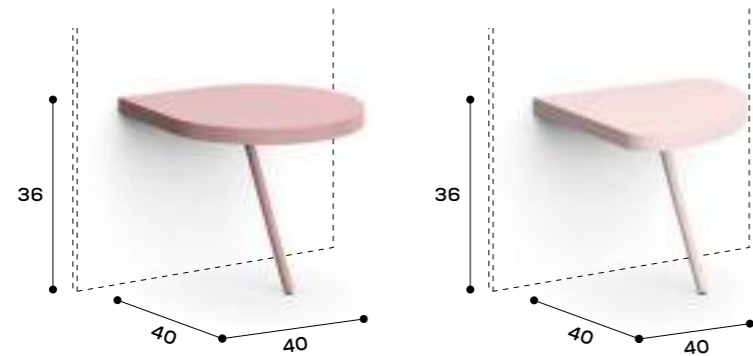

COMODINI SOSPESI BECKY /
BECKY WALL-MOUNTED BEDSIDE TABLES

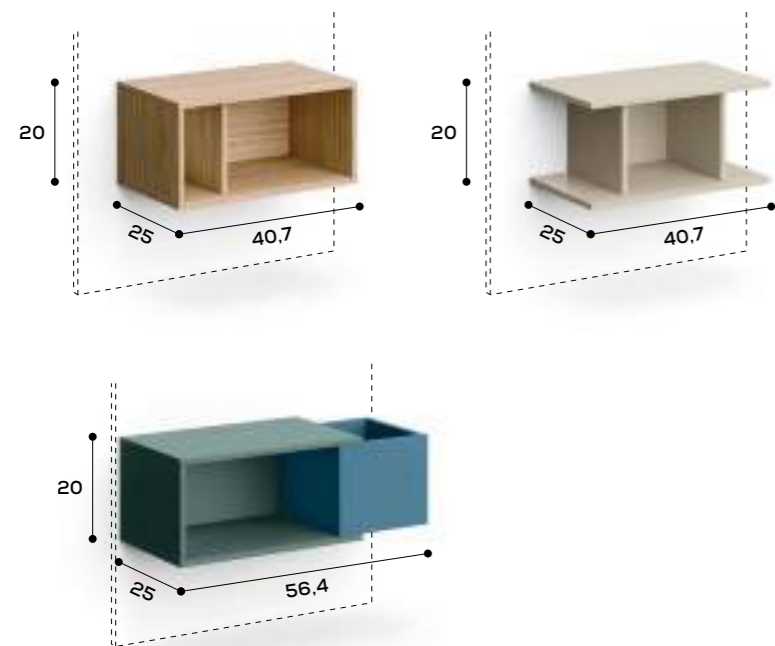

BOISERIE / WALL PANELLING

**BOISERIE BECKY /
BECKY WALL PANELLING**



BOISERIE DOTS / DOTS WALL PANELLING

ALTEZZE E LARGHEZZE / HEIGHTS AND WIDTHS

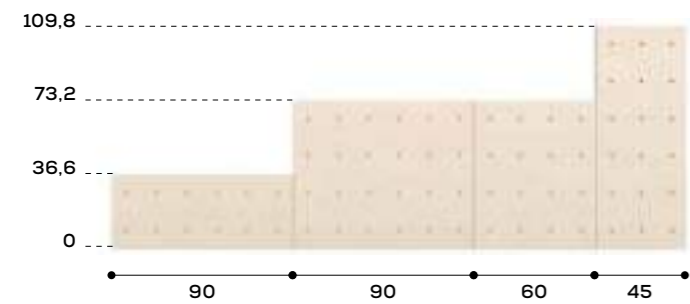

Pannello sp. 2,2 cm, disponibile in finitura legno naturale. /
Panel 2,2 cm thick, available in legno naturale finish.



Guarda come accessorizzare
la boiserie Dots. /
Watch how you can accessorize
Dots wall panelling.

ILLUMINAZIONE A LED / LED LIGHTING

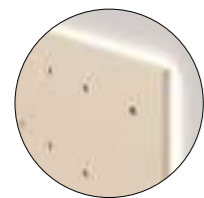

Retroilluminazione a LED /
LED backlighting



BOISERIE / WALL PANELLING

BOISERIE DOTS /
DOTS WALL PANELLING

MENSOLE /
SHELVES

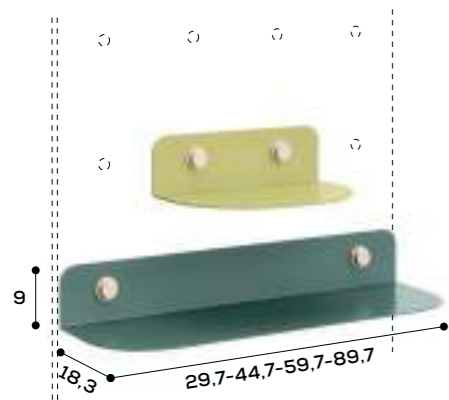

PORTA OGGETTI /
TIDY TRAYS

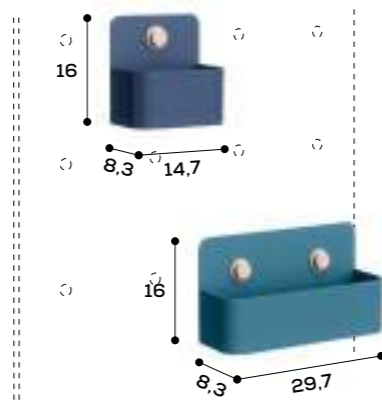

SPECCHIO /
MIRROR

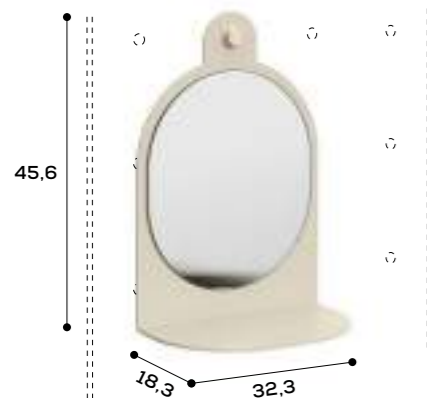

GANCIO /
HOOK

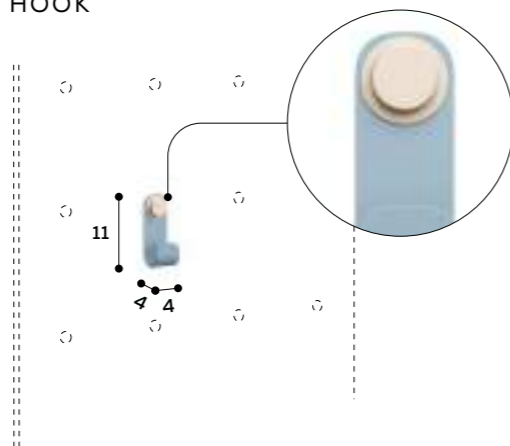

ARMADI WARDROBES

Gli armadi sono modulari e componibili e offrono soluzioni adatte a ogni esigenza di spazio e stile. Dai modelli con ante battenti, ideali per chi desidera massimizzare lo spazio interno, a quelli con ante scorrevoli, che garantiscono una maggiore praticità in ambienti più piccoli. Grazie agli accessori interni, come appendiabiti, cassettiere e ripiani, ogni armadio può essere personalizzato per rispondere alle esigenze organizzative di chi lo utilizza.

Wardrobes are modular and can be arranged into different configurations, offering solutions catering to any space and style requirement. From hinged door models – which are great if you want to maximize internal space – to their sliding door counterparts, which are a more practical option in smaller rooms. With a range of internal accessories – like hanging rails, drawer units and shelves – each wardrobe can be tailored to the organizational needs of its user.

11 ARMADI / WARDROBES



306 Armadi battenti /
Hinged door wardrobes



332 Armadi scorrevoli /
Sliding door wardrobes

ARMADI / WARDROBES

ARMADI BATTENTI /
HINGED DOOR WARDROBES

ANTE INTERE /
ONE-PIECE DOORS

ANTE STAGIONALI /
CENTRE-SPLIT DOORS

MODULO CON
CASSETTI E CASSETTONI /
MODULE WITH REGULAR
AND OVERSIZED DRAWERS

Le schiene sp. 1,2 cm, disponibili
in tutte le finiture, danno un
particolare tocco di colore. /
The 1,2cm-thick back panels,
available in all finishes, provide a
pop of colour.

MODULO CON
VANI A GIORNO /
MODULE WITH
OPEN UNITS

Il modulo sovrapponibile,
disponibile con chiusura rallentata, ti
permette di sfruttare lo spazio anche
in altezza. /
The stackable module, available with
soft-close hinges, allows you to exploit
the height of the interior, too.

Decidere di inserire l'attrezzatura
interna con elementi estraibili è
sempre una buona idea. /
Opting to fit out the interior with
pull-out accessories is always a good
idea.

Il modulo armadio con ante stagionali
consente una doppia apertura per
differenziare al meglio i due vani. /
The wardrobe module with
centre-split doors allows you to open
the top and bottom units separately,
so you can use them for different
purposes.

Le guide rallentate sono comode per
la chiusura del cassetto. /
Soft-close runners are handy to stop
drawers banging shut.

Il modulo senza base permette di avere sempre tutto
in ordine: puoi posizionarci anche i contenitori per i
giochi con ruote. /
The module with no base is great for keeping
everything tidy: it makes a handy home for toy boxes
on wheels, too.

ARMADI BATTENTI / HINGED DOOR WARDROBES

MODULARITÀ /
MODULE SIZES

ALTEZZE / HEIGHTS

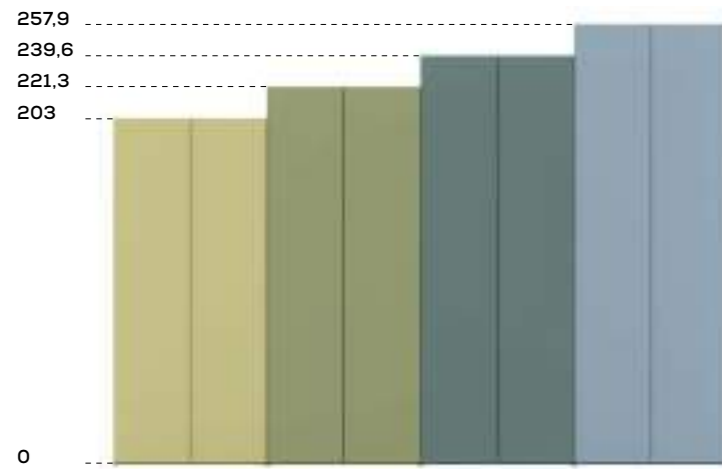

Altezza comprensiva di piedino regolabile H 0,7 cm. /
Height includes adjustable foot H 0,7 cm.

LARGHEZZE E PROFONDITÀ / WIDTHS AND DEPTHS

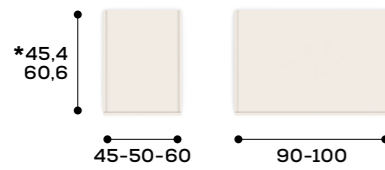

* Non disponibile per larghezza 50 e 100. /
Not an option for 50 and 100 widths.

APERTURE / OPENING OPTIONS

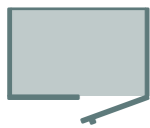

Apertura battente /
Hinged door



ARMADI BATTENTI / HINGED DOOR WARDROBES



ARMADI BATTENTI / HINGED DOOR WARDROBES

MODULI PROFONDITÀ 89,4 CM /
MODULES 89,4 CM DEEP

ALTEZZE / HEIGHTS

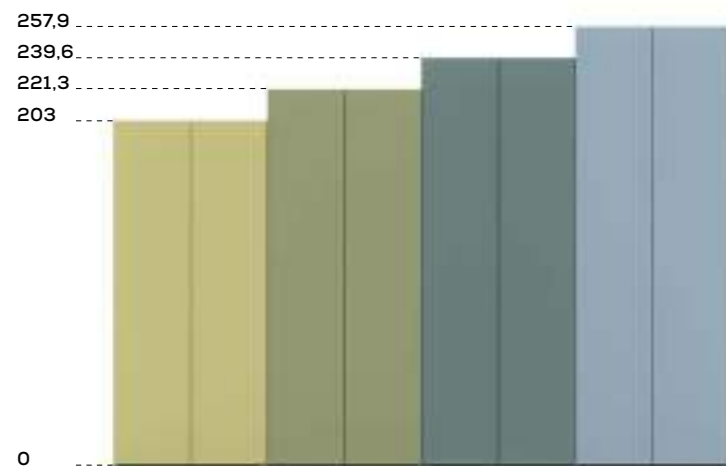

Altezza comprensiva di piedino regolabile H 0,7 cm. /
Height includes adjustable foot H 0,7 cm.

LARGHEZZE E PROFONDITÀ /
WIDTHS AND DEPTH

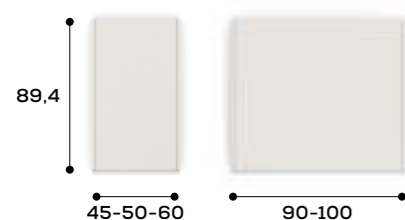

ANGOLO LINEARE /
STRAIGHT CORNER UNIT

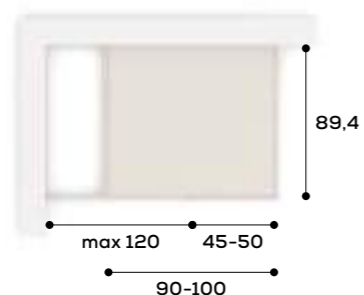

APERTURE / OPENING OPTIONS

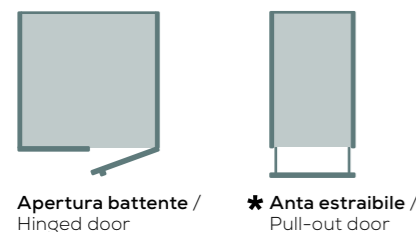

* Disponibile solo per larghezze 45, 60 cm. /
Only available for 45 and 60 cm widths.



ARMADI BATTENTI / HINGED DOOR WARDROBES

ANGOLI /
CORNER UNITS

ANGOLO /
CORNER UNIT

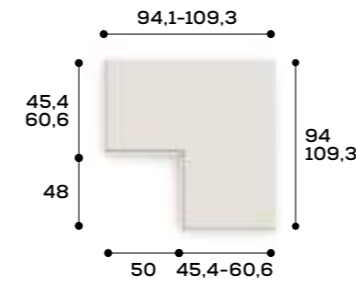

ANGOLO LINEARE /
STRAIGHT CORNER UNIT

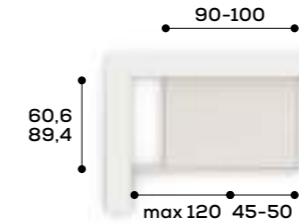

Guarda come sfruttare l'angolo lineare. / Watch how you can make the most of the straight corner unit.

ANGOLI SPOGLIATOIO /
CORNER WALK-IN CLOSETS

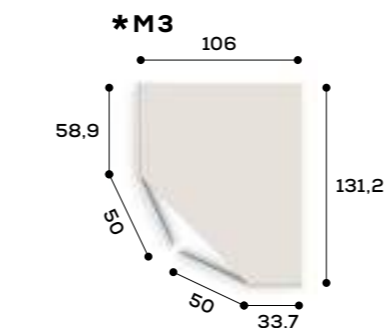
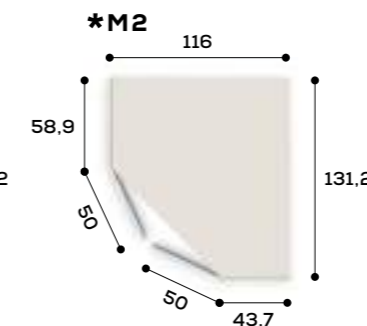
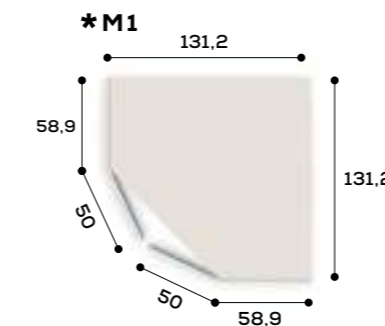
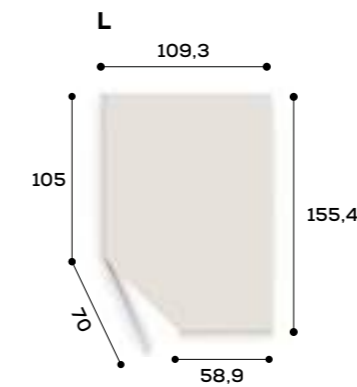
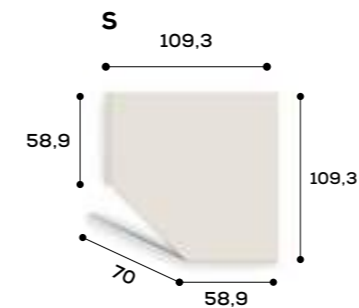

APERTURE ANGOLI SPOGLIATOIO /
CORNER WALK-IN CLOSET OPENING OPTIONS

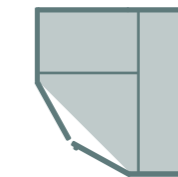

Apertura battente /
Hinged door

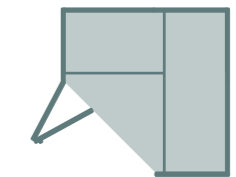

* Apertura pieghevole /
Folding door



* Apertura pieghevole disponibile solo per M1, M2 e M3. / Folding door only an option for M1, M2 and M3.

ARMADI BATTENTI / HINGED DOOR WARDROBES

TERMINALI /
END UNITS



TIPOLOGIE /
TYPES

TRAP

LOOP

KAM

KAM+

BAND

DEN

ALFRED

ALFRED

AMOS

LUCE

PANN

257,9

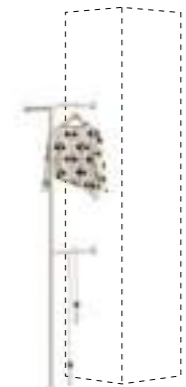
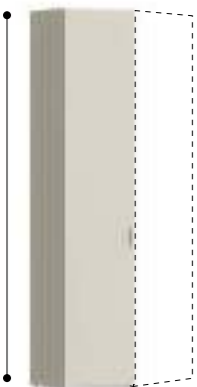

Angolo / Corner unit

ARMADI BATTENTI / HINGED DOOR WARDROBES

MODULI SOVRAPPONIBILI /
STACKABLE MODULES

ALTEZZE / HEIGHTS

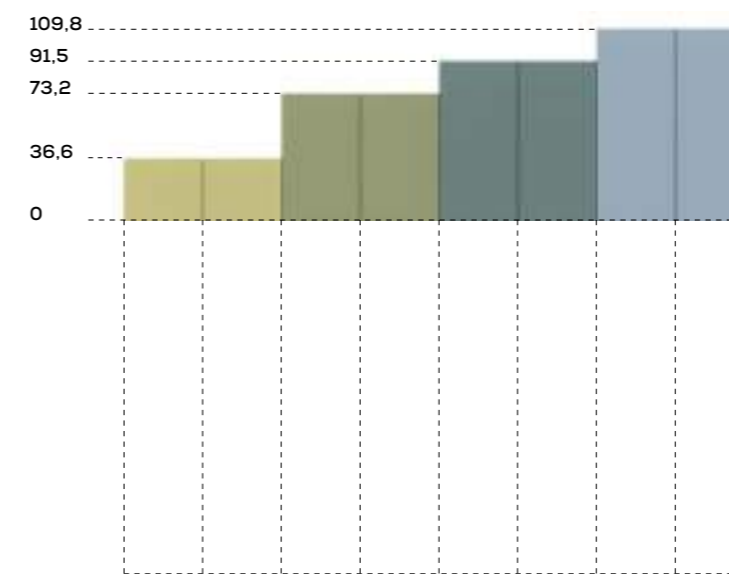

Moduli sovrapponibili disponibili per le altezze 203, 221,3, 239,6, 257,9. /
Stackable modules available for 203, 221.3, 239.6 and 257.9 heights.

LARGHEZZE E PROFONDITÀ / WIDTHS AND DEPTH

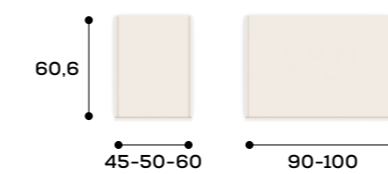

ARMADI BATTENTI / HINGED DOOR WARDROBES

COMPOSIZIONI /
CONFIGURATIONS

PORTA TV PER VANI A GIORNO /
TV MOUNTING BRACKET FOR OPEN UNITS

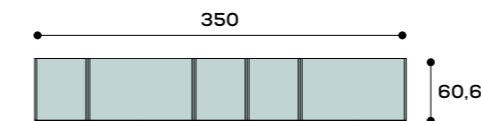
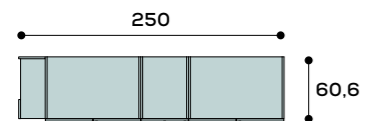

ARMADI BATTENTI / HINGED DOOR WARDROBES

COMPOSIZIONI /
CONFIGURATIONS

ANGOLO SPOGLIATOIO /
CORNER WALK-IN CLOSET



TERMINALE PANN /
PANN END UNIT

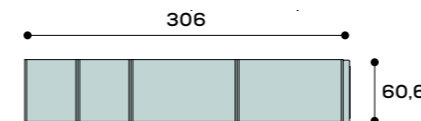
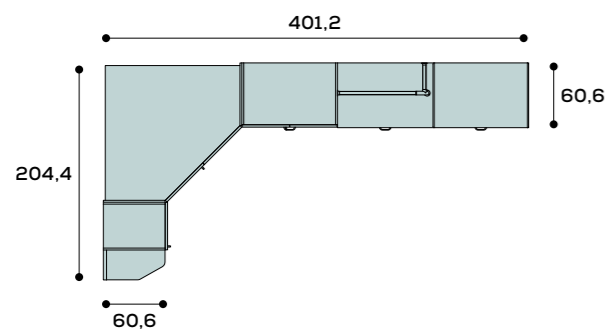

ARMADI BATTENTI / HINGED DOOR WARDROBES

COMPOSIZIONI /
CONFIGURATIONS

MODULO BATTENTE P 89,4 CM /
HINGED DOOR MODULE D 89,4 CM

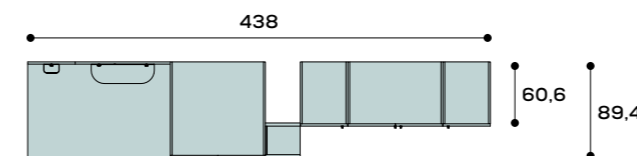
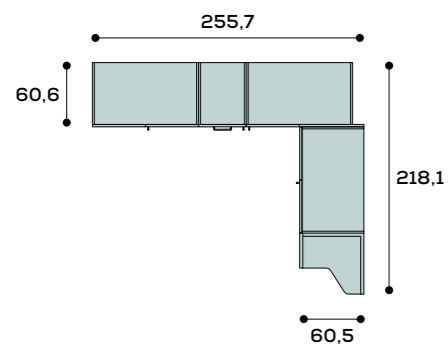

ARMADI BATTENTI / HINGED DOOR WARDROBES

CABINOTTO CABÌ /
CABÌ WALK-IN CLOSET

ALTEZZE / HEIGHTS

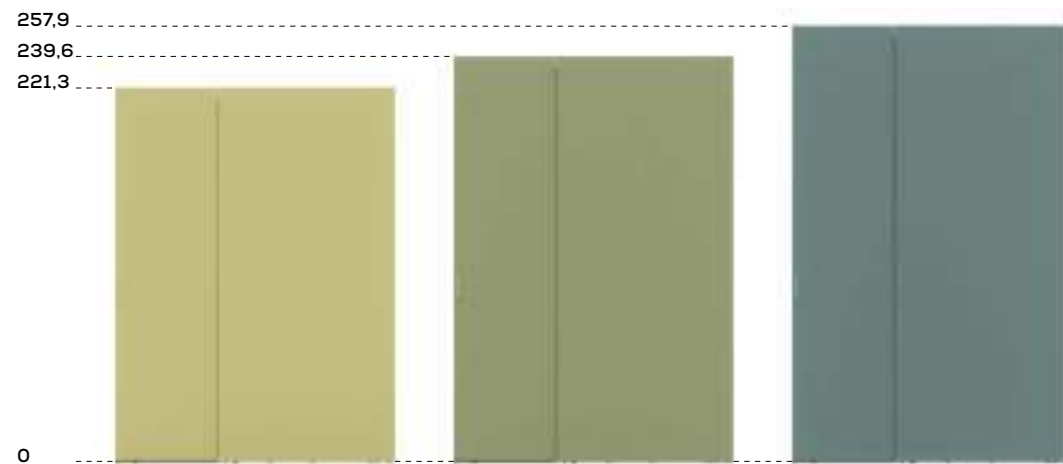

Altezza comprensiva di piedino regolabile H 0,7 cm. /
Height includes adjustable foot H 0,7 cm.

LARGHEZZE E PROFONDITÀ / WIDTHS AND DEPTHS

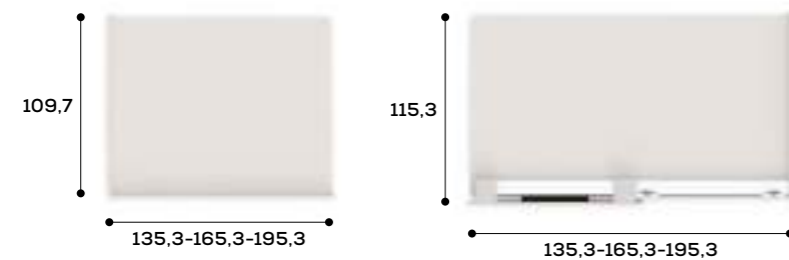

Apertura frontale e pieghevole /
Folding front opening

Apertura scorrevole /
Sliding opening

APERTURE / OPENING OPTIONS

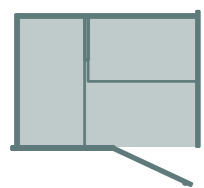

Apertura frontale battente /
Hinged front opening

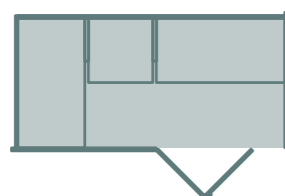

Apertura frontale pieghevole /
Folding front opening



Apertura laterale battente /
Hinged side opening



Apertura frontale scorrevole /
Sliding front opening



ARMADI BATTENTI / HINGED DOOR WARDROBES

CABINOTTO CABÌ / CABÌ WALK-IN CLOSET

INTERNO A SPALLA / WITH LOAD-BEARING SIDE INTERIOR



CABINOTTO CABÌ / CABÌ WALK-IN CLOSET

INTERNO PALÙ / PALÙ INTERIOR



ARMADI / WARDROBES

ARMADI SCORREVOLI / SLIDING DOOR WARDROBES



Le ante scorrevoli sono la soluzione contenitiva salvaspazio. / Sliding doors are a space-saving solution for storage.

Le schiene sp. 1,2 cm, disponibili in tutte le finiture, danno un particolare tocco di colore. / The 1,2cm-thick back panels, available in all finishes, provide a pop of colour.

Pratico sistema di apertura-chiusura automatica ammortizzata Soft Space che consente una chiusura ed un'apertura a velocità controllata senza sobbalzi. / Practical Soft Space automatic soft opening/closing system enabling the door to be opened and closed smoothly at a controlled speed.

L'anta scorrevole Nit può essere abbinata ad un'ampia scelta di maniglie, per un armadio mai banale. / The Nit sliding door can be teamed with a wide range of handles, for a wardrobe that's never just average.

L'armadio scorrevole è personalizzabile con una vasta scelta di accessori, come cassettiere, tubi appendiabiti e molto altro! / The sliding door wardrobe can be customized with an extensive selection of accessories, such as drawer units, hanging rails and much more!

ARMADI SCORREVOLI / SLIDING DOOR WARDROBES

MODULARITÀ /
MODULE SIZES

ALTEZZE / HEIGHTS



Altezza comprensiva di piedino regolabile H 0,7 cm. /
Height includes adjustable foot H 0.7 cm.

LARGHEZZE / WIDTHS



PROFONDITÀ E SPESSORI ANTE / DEPTHS AND DOOR THICKNESSES

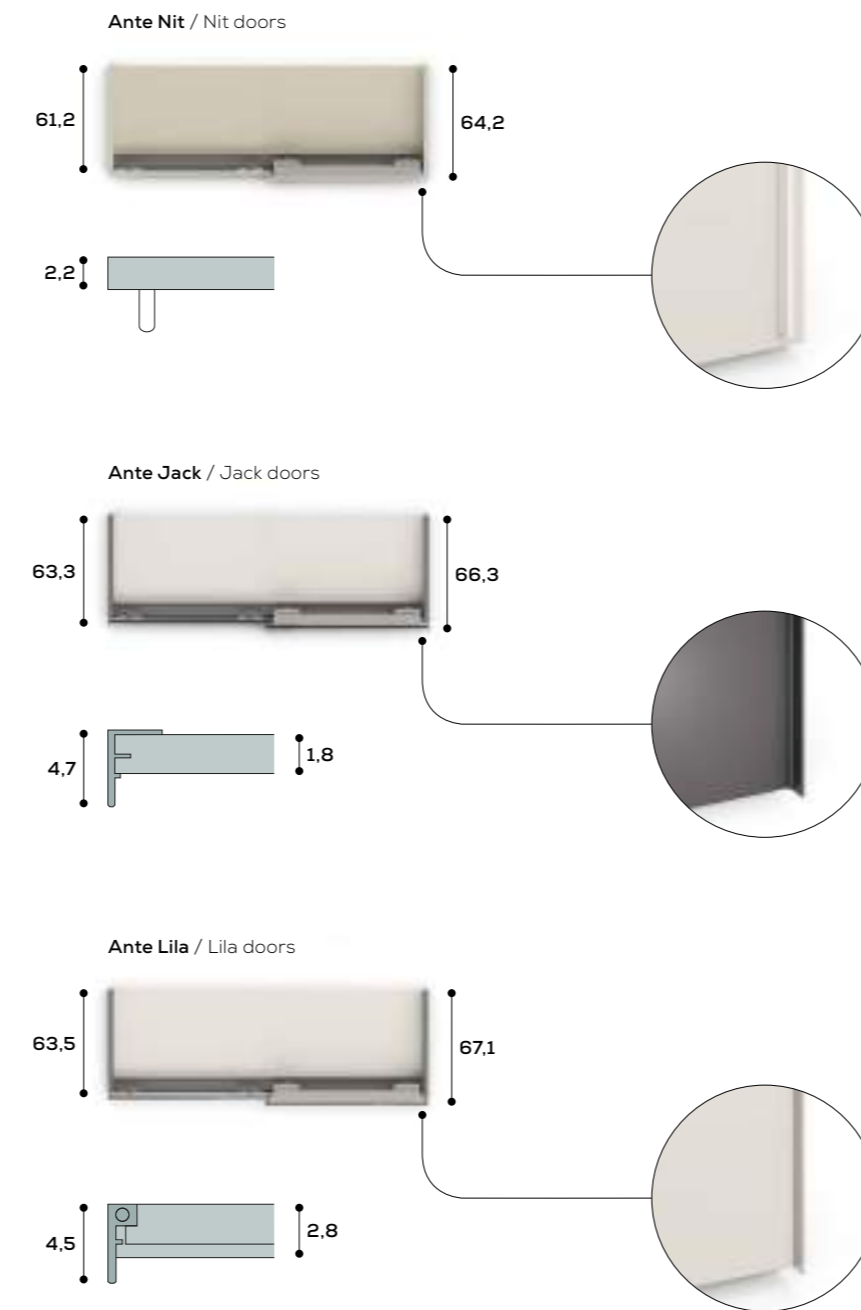

ARMADI SCORREVOLI / SLIDING DOOR WARDROBES

ANTE /
DOORS

LILA 01A



LILA 01B



LILA 03A



LILA 03B

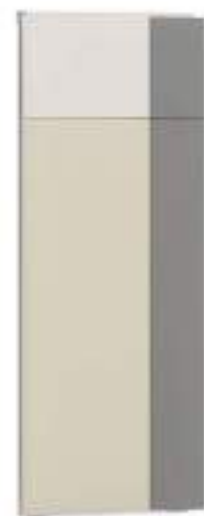

LILA 03C



LILA 03D

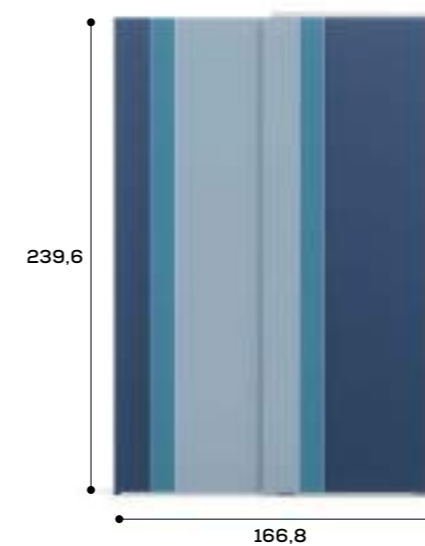
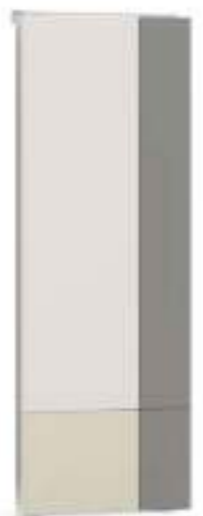

ARMADI SCORREVOLI / SLIDING DOOR WARDROBES



ARMADI SCORREVOLI / SLIDING DOOR WARDROBES

ANTE /
DOORS



NIT

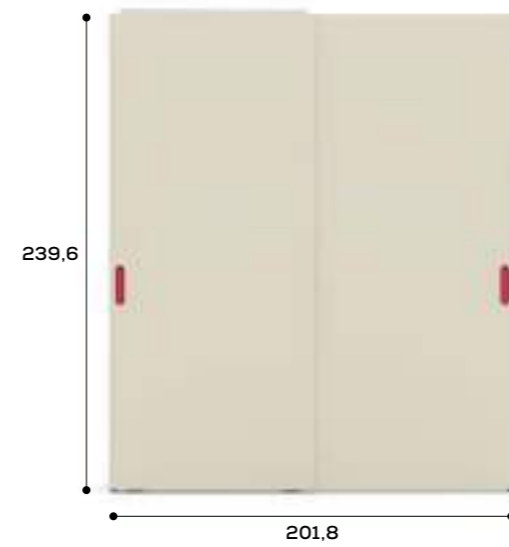

JACK

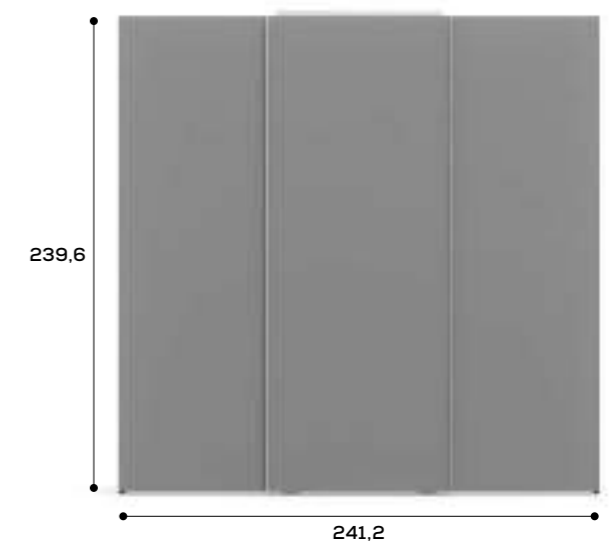

Sono disponibili tutti i modelli di maniglie, ad esclusione di: Shell, Poddy, Fefè, Dot, Brick, Puzzle e Woody. /
Can be ordered with any of the handle models, except: Shell, Poddy, Fefè, Dot, Brick, Puzzle and Woody.



ARMADI / WARDROBES

ACCESSORI INTERNI /
INTERNAL ACCESSORIES

Guarda come puoi
accessoriare l'armadio. /
Watch how you can
accessorize the wardrobe.



Elemento estraibile con
3 ripiani orientabili /
Pull-out unit with 3
revolving racks

Appendiabiti
estraibile /
Extending
hanging rail

Ripiano
portascarpe /
Shoe rack shelf

Servetto appendiabiti
estensibile o motorizzato /
Extending or motorized
clothes lift

Ripiano estraibile /
Pull-out shelf

Faretto LED con
2 prese USB /
LED spotlight
with 2 USB
sockets

Sacca estraibile /
Pull-out hamper

Lampada LED ad
aggancio magnetico a
batterie ricaricabili /
Magnetic LED light with
rechargeable batteries

Vaschette
estraibili /
Pull-out
caddies

Vassoio
estraibile /
Pull-out tray

Portapantaloni e
stendibiancheria
estraibili /
Pull-out trouser rack
and drying rack

Tubo appendiabiti
dinamico /
Swing-out
hanging rail

PONTI BRIDGING UNITS

I ponti Nidi permettono di sfruttare al massimo lo spazio in camera. I modelli lineari sono perfetti per creare soluzioni pratiche sopra il letto, mentre i ponti ad angolo offrono un maggiore spazio per contenere. Ogni elemento è modulare e si adatta perfettamente alle esigenze di spazio e alla personalità dell'ambiente.

Nidi bridging units allow you to make the best use of space in the room. Straight models are perfect for creating practical solutions over the bed, while corner bridging units offer even more storage space. Each element is modular so it can be tailored to meet the room's space requirements and suit its personality.

12 PONTI / BRIDGING UNITS



348 Ponti /
Bridging units



PONTI / BRIDGING UNITS

MODULARITÀ /
MODULE SIZES

ALTEZZE / HEIGHTS

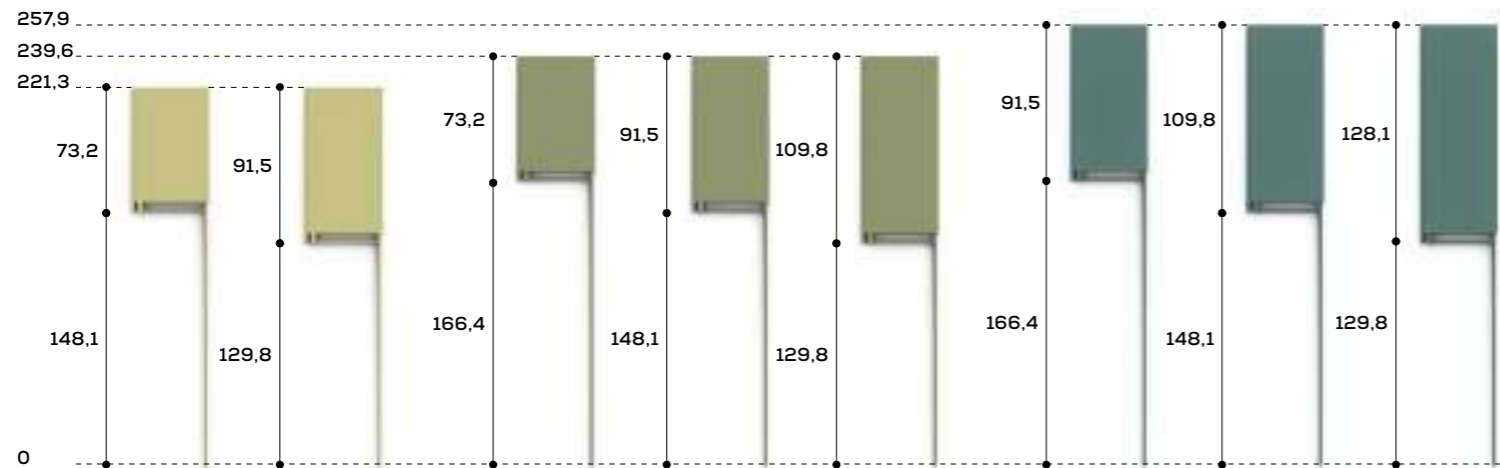

LARGHEZZE E PROFONDITÀ / WIDTHS AND DEPTHS

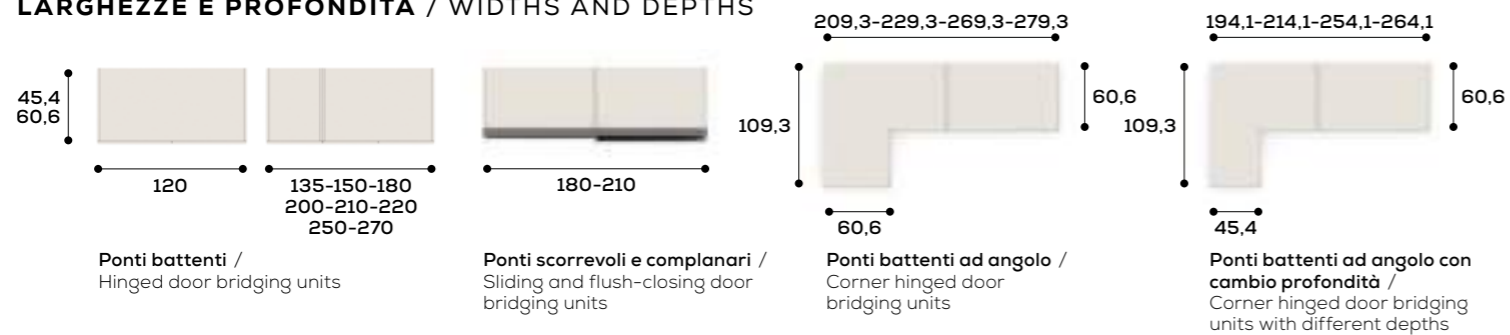

FIANCHI DI SOSTEGNO / SUPPORTING SIDE PANELS

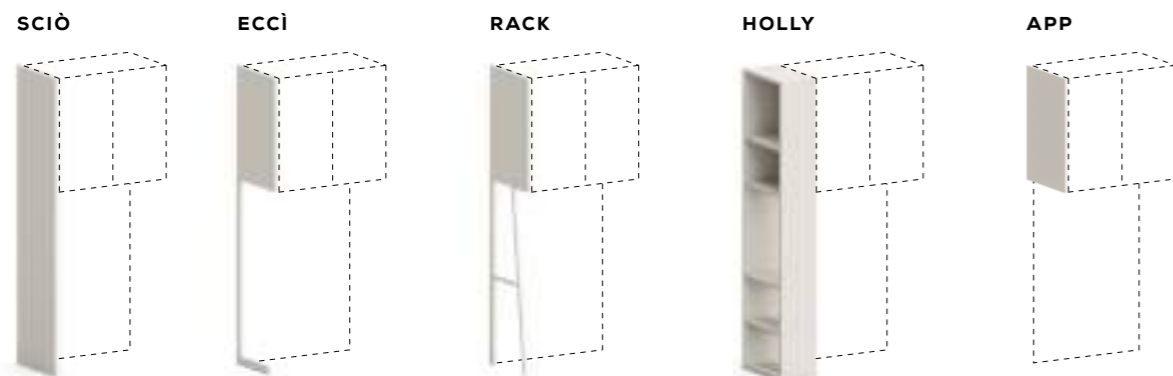

Tutti i fianchi sono disponibili in versione laterale e centrale. Il fianco Holly laterale è disponibile anche con schiena. Il fianco App è disponibile solo per ponti lineari. / All side panels come in end side and central versions. The Holly end side panel is also available with a back panel. The App side panel is an option for straight bridging units only.



PONTI / BRIDGING UNITS

COMPOSIZIONI /
CONFIGURATIONS

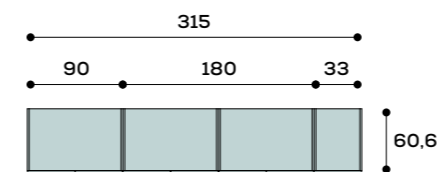
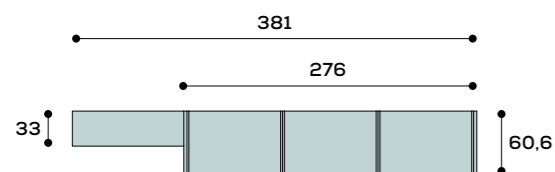

PONTI / BRIDGING UNITS

COMPOSIZIONI / CONFIGURATIONS

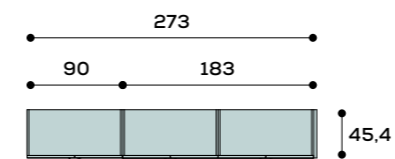
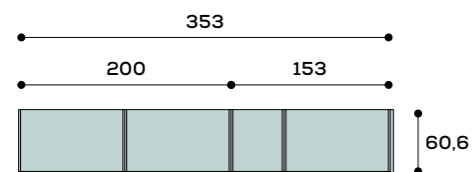

PONTI / BRIDGING UNITS



PONTI / BRIDGING UNITS

**LIBRERIA HOLLY SOTTOPONTE /
HOLLY UNDER-BRIDGE BOOKCASE**

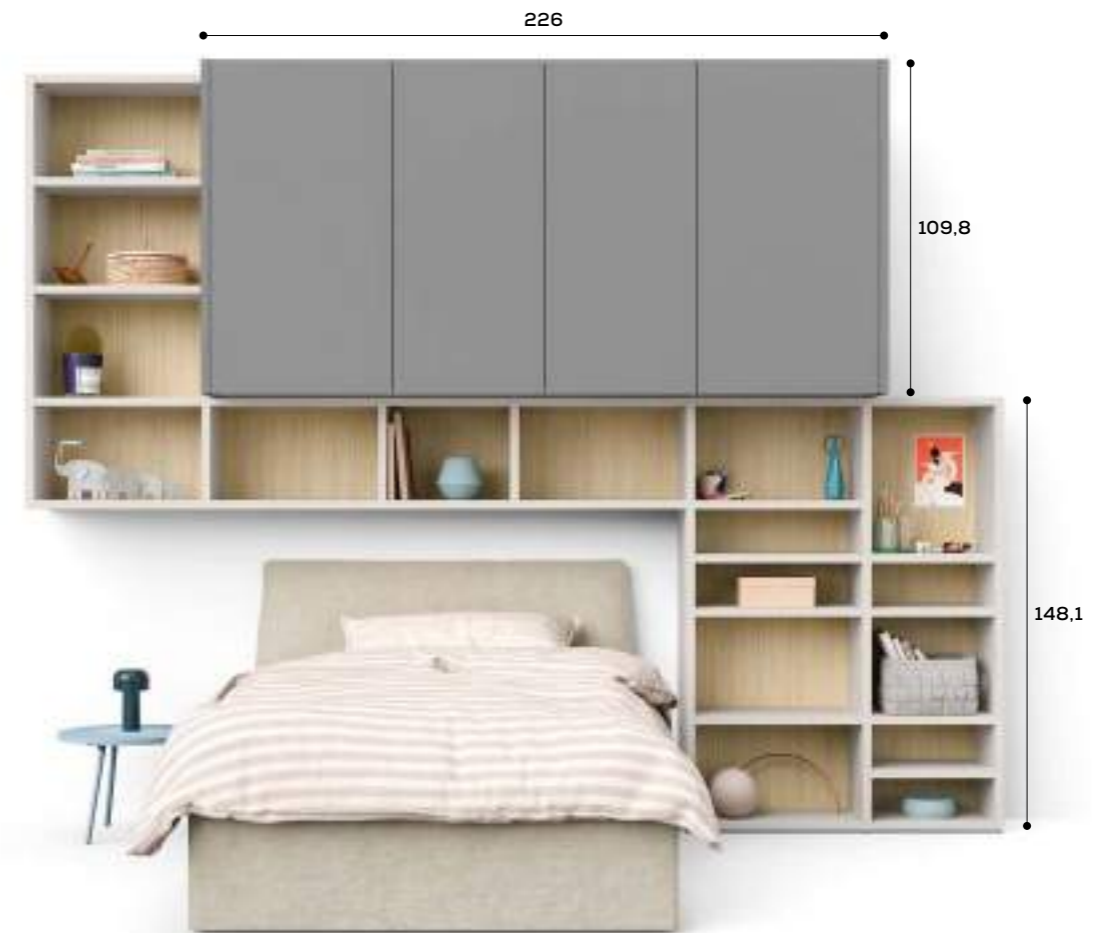

**TIPOLOGIE /
TYPES**

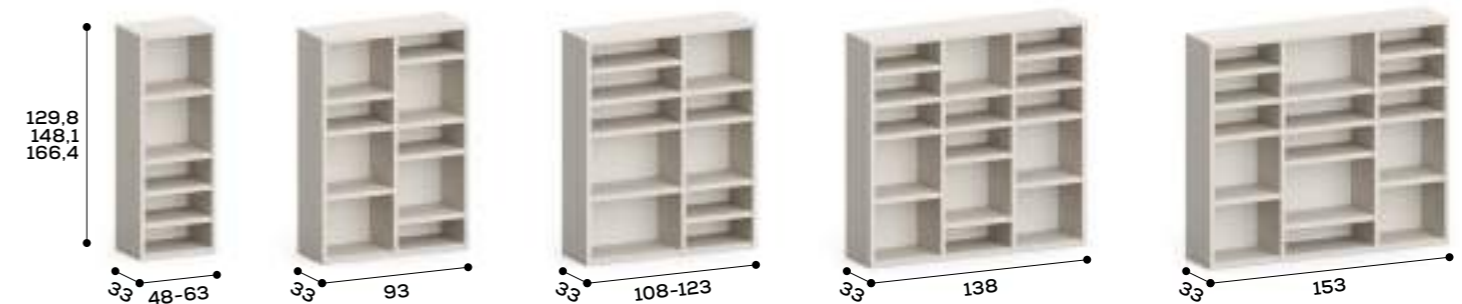

PONTI / BRIDGING UNITS

COMPOSIZIONI / CONFIGURATIONS

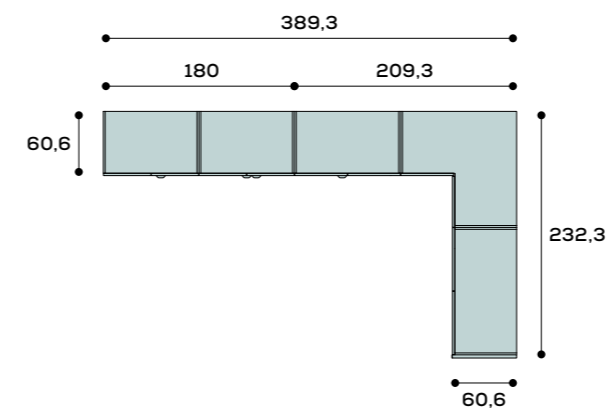
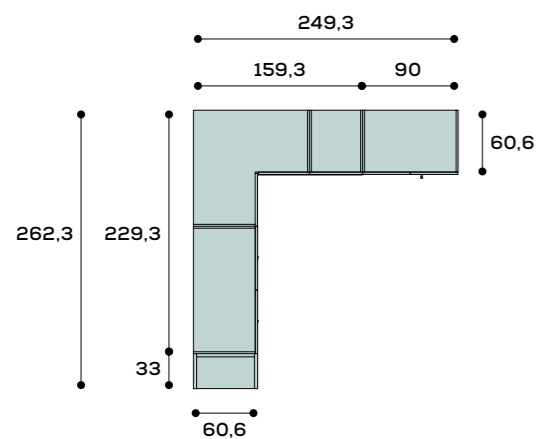



CABINE WALK-IN CLOSETS

Le cabine armadio di Nidi offrono massima funzionalità e organizzazione. Con accessori come cassettiere, ripiani estraibili e tubi appendiabiti, ogni cabina può essere configurata secondo le singole esigenze. Il design contemporaneo e le opzioni modulari le rendono perfette per mantenere in ordine la stanza.

Nidi walk-in closets offer the ultimate functionality and organization. With accessories like drawer units, pull-out shelves and hanging rails, each wardrobe can be configured to suit individual requirements. Their contemporary design and modular options make them perfect for keeping any room neat and tidy.

13 CABINE / WALK-IN CLOSETS



364 Cabina Demo a spalla /
Demo walk-in closet system
with load-bearing side panels



374 Chiusure /
Closing systems

CABINE / WALK-IN CLOSETS

CABINA DEMO A SPALLA / DEMO WALK-IN CLOSET SYSTEM WITH LOAD-BEARING SIDE PANELS

CABINA A TERRA /
FLOORSTANDING WALK-IN CLOSET

CABINA SOSPESA /
WALL-MOUNTED WALK-IN CLOSET



CABINA DEMO A SPALLA / DEMO WALK-IN CLOSET SYSTEM WITH LOAD-BEARING SIDE PANELS

**MODULARITÀ /
MODULE SIZES**

ALTEZZE / HEIGHTS

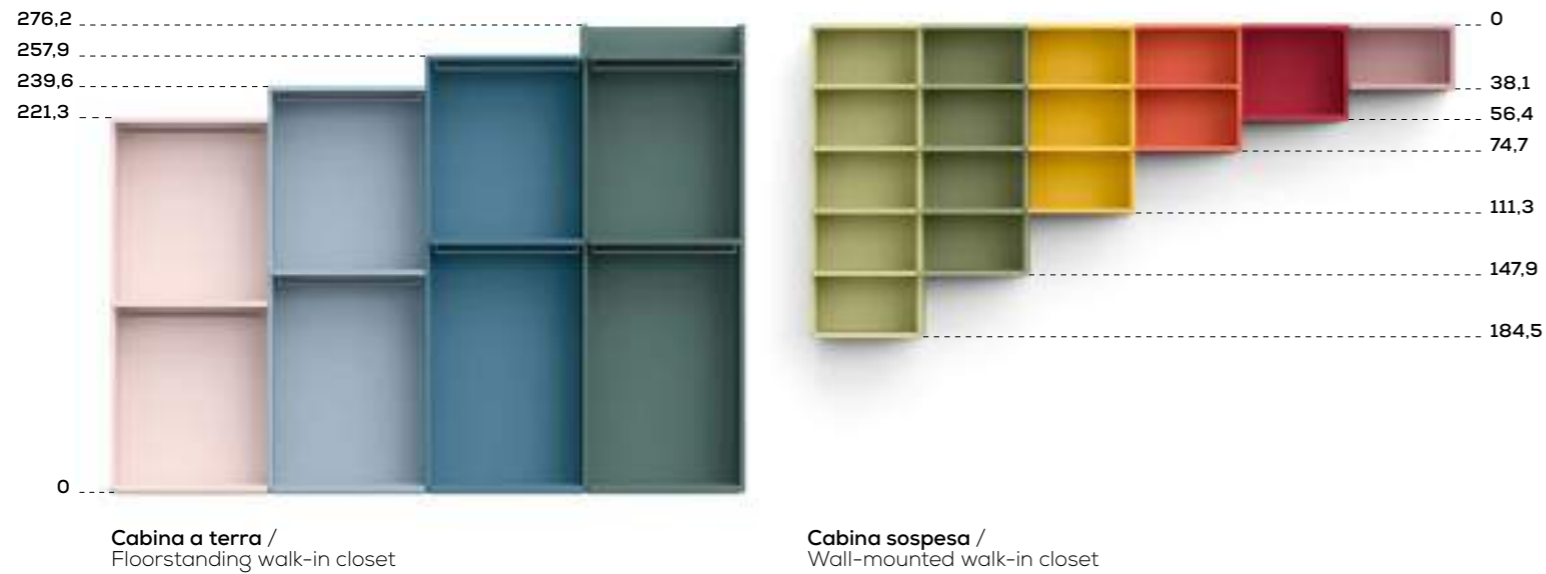

LARGHEZZE E PROFONDITÀ / WIDTHS AND DEPTHS

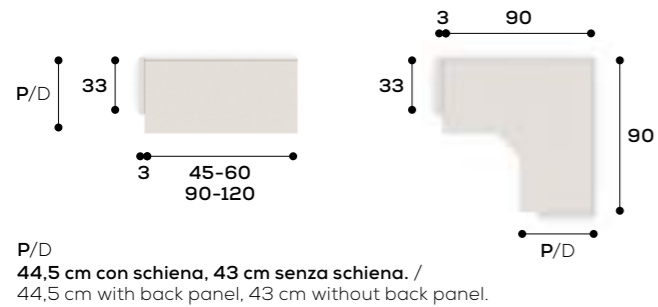

COMPONENTI / COMPONENTS

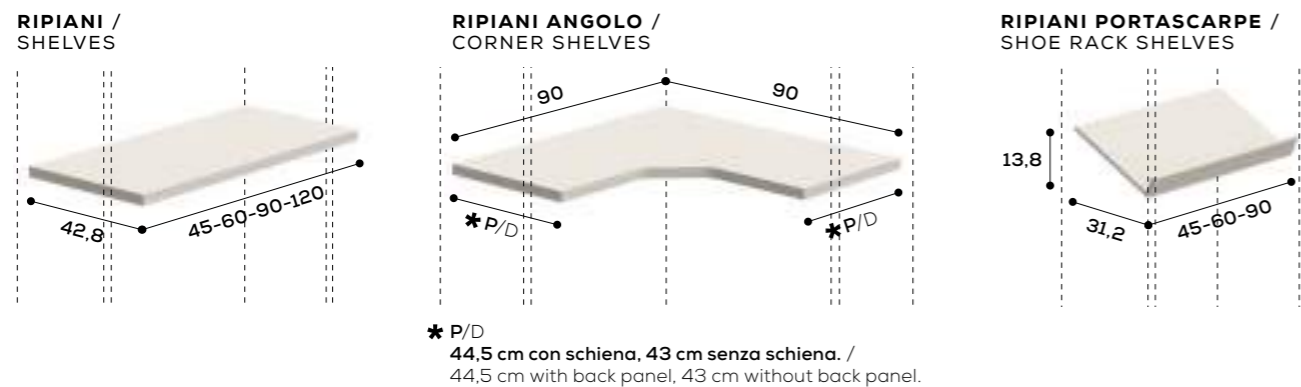

CABINA DEMO A SPALLA / DEMO WALK-IN CLOSET SYSTEM WITH LOAD-BEARING SIDE PANELS



CABINA DEMO A SPALLA / DEMO WALK-IN CLOSET SYSTEM WITH LOAD-BEARING SIDE PANELS



370



371



CABINA DEMO A SPALLA / DEMO WALK-IN CLOSET SYSTEM WITH LOAD-BEARING SIDE PANELS

ATTREZZATURA /
FITTINGS

Servetto appendiabiti
estensibile /
Extending clothes lift

Portapantaloni
estraibile /
Pull-out trouser rack

Ripiani portascarpe /
Shoe rack shelves

Appendiabiti Loop /
Loop hanging rods

Tubi appendiabiti /
Hanging rails

Ripiani /
Shelves

Cassettiera /
Drawer unit

CHIUSURE / CLOSING SYSTEMS

TIPOLOGIE / TYPES

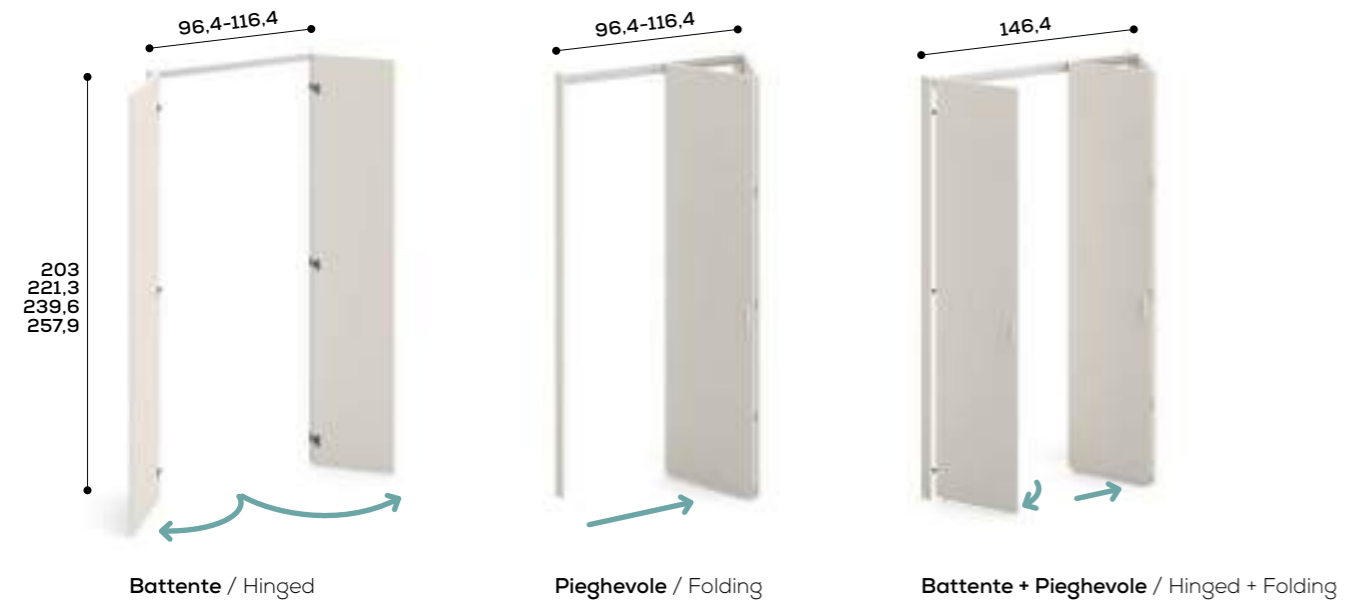

ESEMPI DI UTILIZZO / EXAMPLES OF USE

Passaggio tra montante compensatore e muro /
Opening between filler upright and wall



Passaggio tra muro ed armadio /
Opening between wall and wardrobe

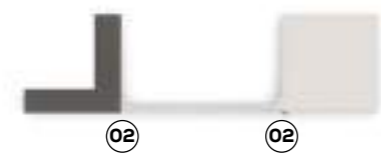

Passaggio tra 2 contenitori-armadi /
Opening between 2 storage units/wardrobes



Passaggio tra armadio e contenitore /
Opening between wardrobe and storage unit

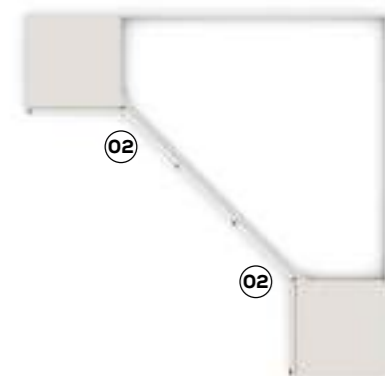

Passaggio tra armadio e muro /
Opening between wardrobe and wall

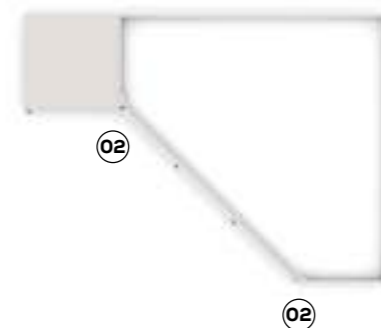

01 Montante compensatore. /
Filler upright.



02 Fianco stipite sp. 1,8 cm. /
Jamb side panel depth 1.8 cm.



CHIUSURE / CLOSING SYSTEMS



BASI, CONTENITORI, ALZATE E PENSILI BASE, STORAGE, TOP AND WALL UNITS

Le basi, i contenitori e i pensili sono ideali per arredare gli spazi con versatilità. Le basi possono includere cassetti o ante, mentre i pensili e i contenitori sospesi sfruttano al meglio le pareti, creando composizioni pratiche e funzionali. Disponibili in vari colori e dimensioni, sono perfetti per personalizzare l'ambiente.

Base, storage and wall units are ideal as a versatile addition to the space's interior scheme. Base units can include drawers or doors, while wall units and wall-mounted storage units make the most of wall space, creating practical and functional arrangements. Available in various colours and sizes, they're perfect for personalizing the room.

14 BASI, CONTENITORI, ALZATE E PENSILI / BASE, STORAGE, TOP AND WALL UNITS



382 **Basi /**
Base units



386 **Contenitori e alzate /**
Storage and top units



390 **Pensili /**
Wall units



394 **Woody**

BASI, CONTENITORI, ALZATE E PENSILI / BASE, STORAGE, TOP AND WALL UNITS



BASI / BASE UNITS

BASI A TERRA E IN APPOGGIO / FLOORSTANDING AND SIT-ON-TOP BASE UNITS

ALTEZZE BASI A TERRA / FLOORSTANDING BASE UNIT HEIGHTS

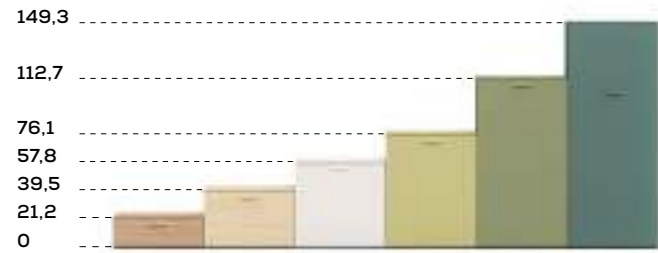

Altezze comprensive di piedini H 0,7 cm e di top di finitura sp. 1,2 cm. / Heights include 0,7cm-high feet and 1,2cm-thick finishing top.

ALTEZZE BASI IN APPOGGIO / SIT-ON-TOP BASE UNIT HEIGHTS

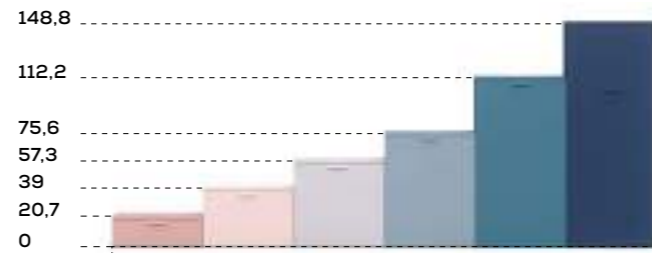

Altezze comprensive di top di finitura sp. 1,2 cm. / Heights include 1,2cm-thick finishing top.

LARGHEZZE E PROFONDITÀ / WIDTHS AND DEPTHS

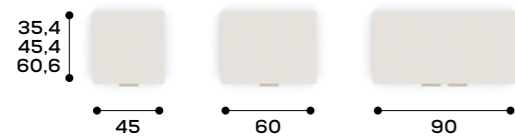

ANGOLI / CORNER UNITS

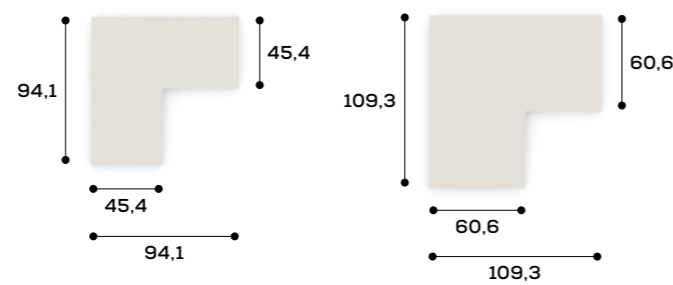

TOP AL METRO LINEARE / TOP PER LINEAR METRE

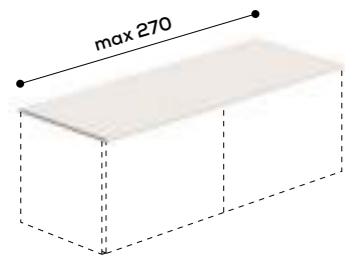

Sp. 1,2 cm, per profondità 35,8, 45,8, 61. / 1,2 cm thick, for 35,8, 45,8 and 61 depths.

PEDANE AL METRO LINEARE / PLINTHS PER LINEAR METRE

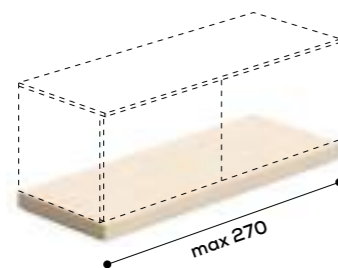

Sp. 3 cm e 5 cm, con piedini H 0,7 cm e per profondità 35,8, 45,8, 61. / 3 cm and 5 cm thick, with 0,7cm-high feet and for 35,8, 45,8 and 61 depths.

SEDILE IMBOTTITO SOPRA TOP / PADDED SEAT FOR TOP

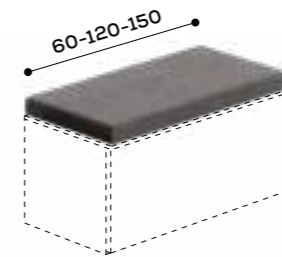

Sp. 6 cm, per profondità 35,8, 45,8, 61 e disponibile in tutti i tessuti. / 6 cm thick, for 35,8, 45,8 and 61 depths and available in all fabrics.



BASI / BASE UNITS

BASI A TERRA E IN APPOGGIO /
FLOORSTANDING AND SIT-ON-TOP BASE UNITSTIPOLOGIE APERTURE /
OPENING TYPES

- 01 anta battente / hinged door
sp. 2,2 cm / 2,2 cm thick
- 02 anta rialza / lift-up door
sp. 2,2 cm / 2,2 cm thick
- 03 anta ribalta / pull-down door
sp. 2,2 cm / 2,2 cm thick
- 04 cassetti / drawers
sp. 2,2 cm / 2,2 cm thick
- 05 cassettone / oversized drawer
sp. 2,2 cm / 2,2 cm thick
- 06 ripiani / shelves
sp. 3 cm / 3 cm thick

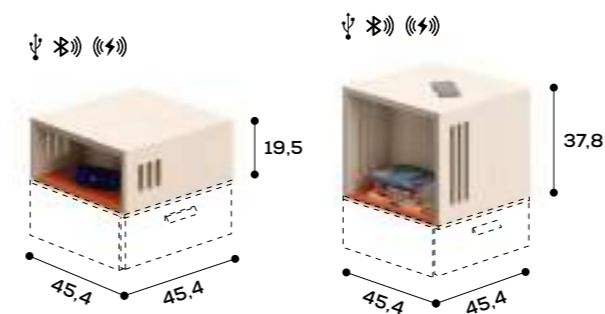
ELEMENTO JACK IN APPOGGIO /
JACK UNIT SITTING ON TOP



**Doppia presa
USB /
Double USB
socket**



**Casse acustiche
Bluetooth /
Bluetooth
speakers**



**Ricarica wireless
sottopiano /
Undermounted
wireless charging**

Elemento Jack sp. 2,2 cm in finitura legno naturale.
 È disponibile in diverse versioni: doppia presa USB, doppia presa USB e casse acustiche Bluetooth, doppia presa USB e ricarica wireless sottopiano, doppia presa USB, casse acustiche Bluetooth e ricarica wireless sottopiano. /
 Jack unit 2,2 cm thick in legno naturale finish.
 It comes in a number of versions: double USB socket; double USB socket and Bluetooth speakers; double USB socket and undermounted wireless charging; double USB socket, Bluetooth speakers and undermounted wireless charging.

ACCESSORI PER BASI /
BASE UNITS ACCESSORIES



**Ricarica wireless sottopiano /
Undermounted wireless charging**



**Boccola passacavi circolare
in plastica /
Plastic round wiring grommet**



**Boccola passacavi circolare in
metallo /
Metal round wiring grommet**



**Boccola passacavi
rettangolare in plastica /
Plastic rectangular wiring
grommet**



**Boccola passacavi
rettangolare in metallo /
Metal rectangular wiring
grommet**

CONTENITORI E ALZATE / STORAGE AND TOP UNITS

MODULARITÀ /
MODULE SIZES

ALTEZZE CONTENITORI /
STORAGE UNIT HEIGHTS

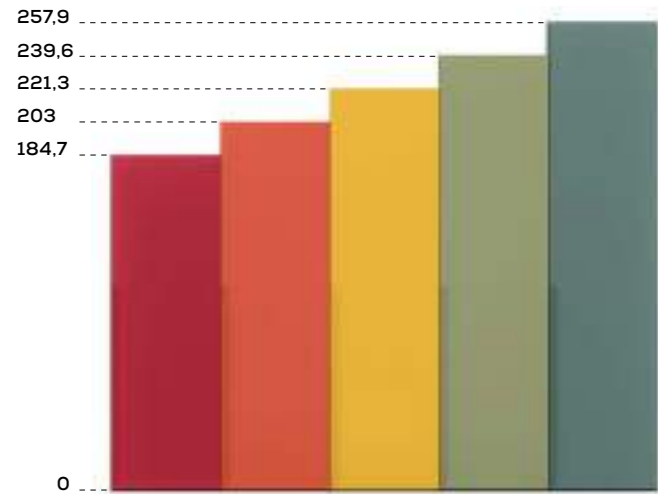

Profondità 35,4, 45,4 cm. Altezze comprensive di piedini H 0,7 cm. /
35,4, 45,4 cm deep. Heights include 0,7cm-high feet.

ALTEZZE ALZATE /
TOP UNIT HEIGHTS

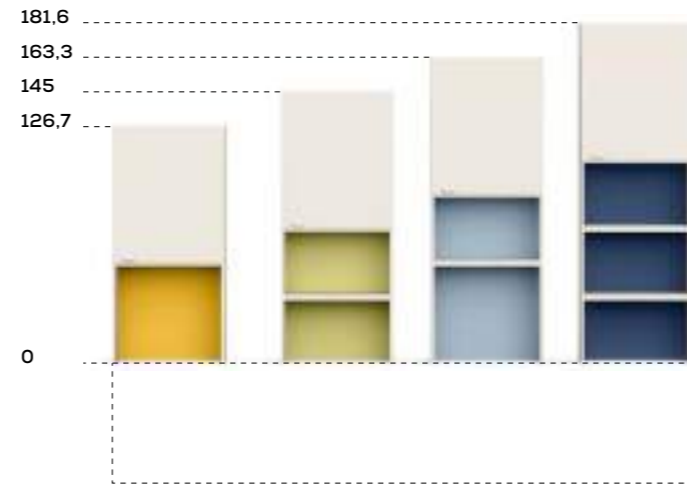

Profondità 35,4. /
35,4 cm deep.

LARGHEZZE E PROFONDITÀ /
WIDTHS AND DEPTHS

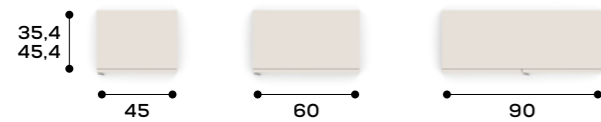

ANGOLO /
CORNER UNIT

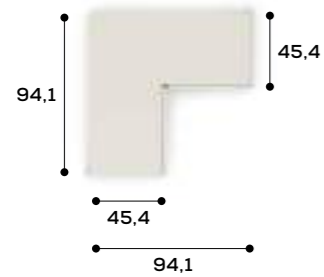

TERMINALI /
END UNITS

TIPOLOGIE PER CONTENITORI PROFONDITÀ 45,4 - 35,4 CM /
OPTIONS FOR STORAGE UNIT DEPTHS OF 45,4 - 35,4 CM

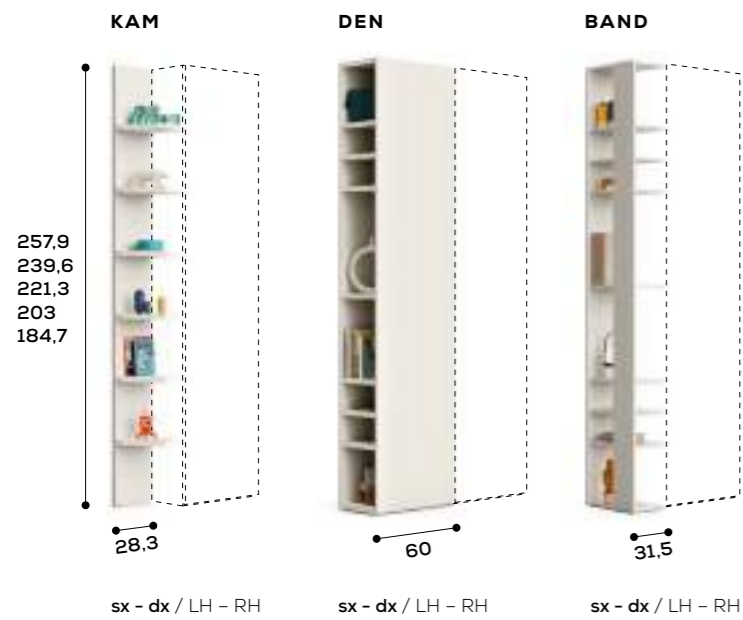

PENSILI / WALL UNITS

MODULARITÀ /
MODULE SIZES

ALTEZZE / HEIGHTS

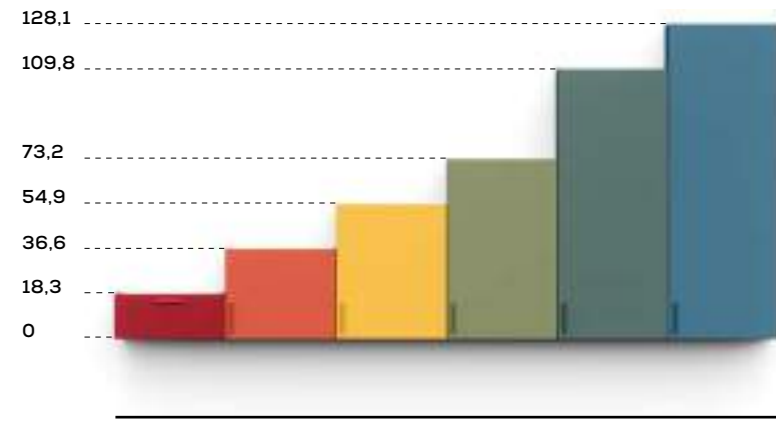
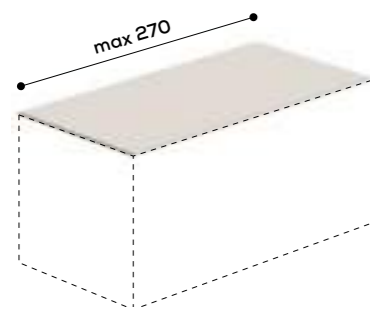
LARGHEZZE E PROFONDITÀ /
WIDTHS AND DEPTHSTOP AL METRO LINEARE /
TOP PER LINEAR METRE

Sp. 1,2 cm, per profondità 35,8, 45,8, 61 cm. /
1,2 cm thick, for 35,8, 45,8 and 61 depths.

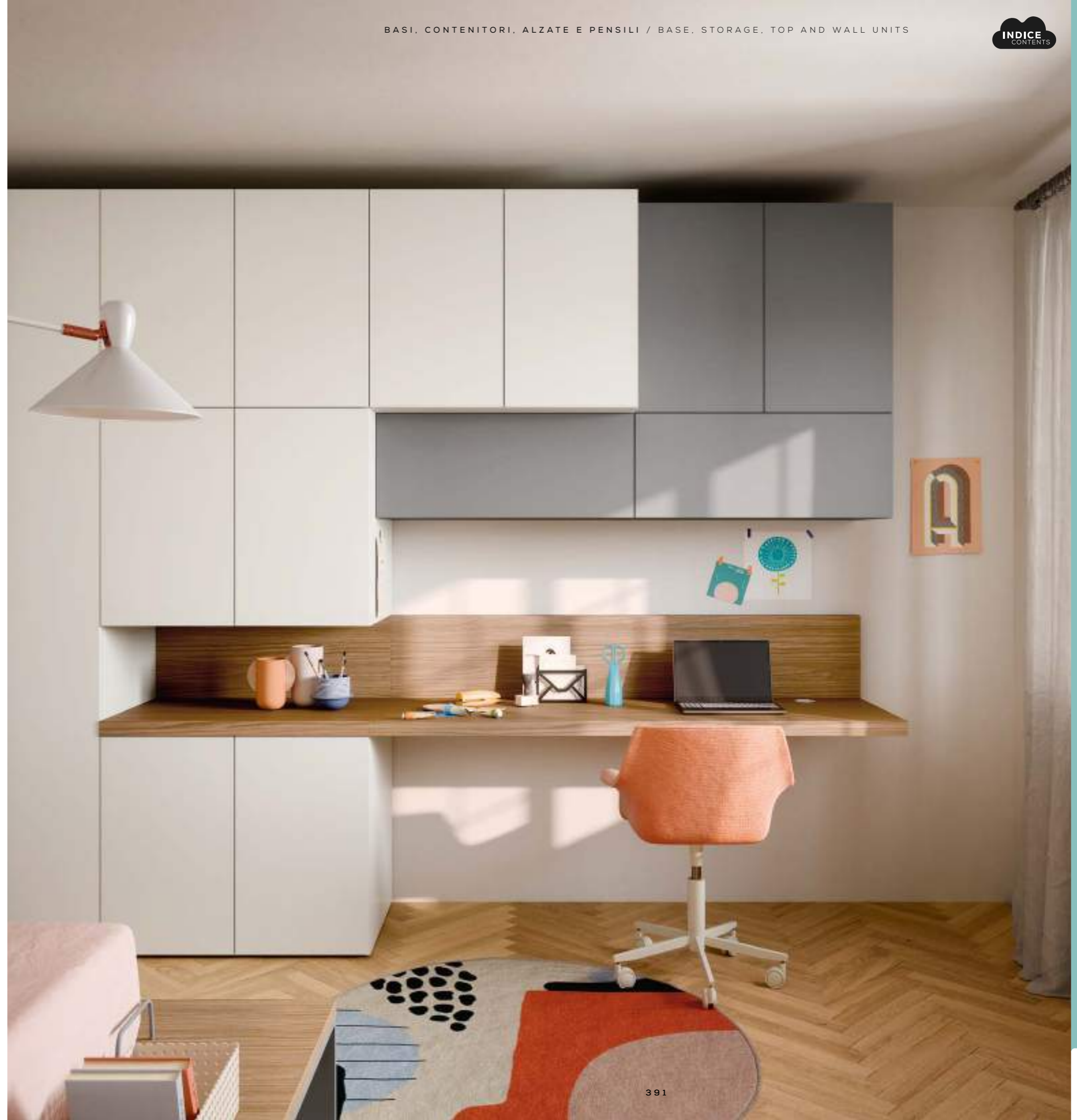



PENSILI / WALL UNITS

PENSILI /
WALL UNITS

TIPOLOGIA APERTURE / OPENING TYPES



- 01 anta battente / hinged door
sp. 2,2 cm / 2,2 cm thick
- 02 anta rialza / lift-up door
sp. 2,2 cm / 2,2 cm thick
- 03 anta ribalta / pull-down door
sp. 2,2 cm / 2,2 cm thick
- 04 cassetti / drawers
sp. 2,2 cm / 2,2 cm thick
- 05 cassettone / oversized drawer
sp. 2,2 cm / 2,2 cm thick
- 06 ripiani / shelves
sp. 3 cm / 3 cm thick

WOODY

ARMADI E MADIE WOODY /
WOODY WARDROBES AND SIDEBOARDS

Gli armadi e le madie Woody uniscono design minimalista e funzionalità versatile. Queste composizioni free standing si distinguono per caratteristiche funzionali diverse, ma condividono un elemento distintivo: la gamba Woody, base iconica che conferisce uniformità ed eleganza al design.

Woody wardrobes and sideboards combine minimalist design with versatile function. While these freestanding configurations may differ in terms of their functional features, they all share the same distinctive trait: the Woody leg, an iconic base that gives the design its cohesive and elegant look.

ARMADI E MADIE WOODY / WOODY WARDROBES AND SIDEBOARDS

ARMADI WOODY / WOODY WARDROBES



Sono disponibili nella versione dx e sx. / They come in a RH and LH version.

CASSETTIERE INTERNE PROFONDITÀ 45,4 CM / INTERNAL DRAWER UNITS 45.4 CM DEEP

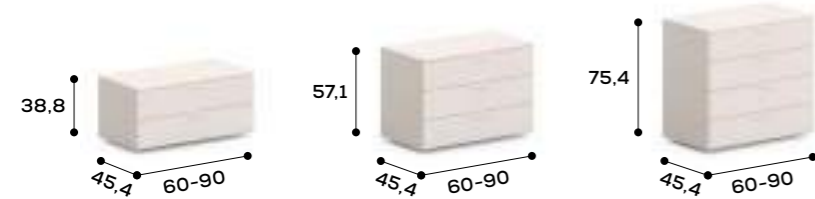

Da posizionare in centro vano. / To be positioned in middle of compartment.

CASSETTIERE INTERNE PROFONDITÀ 48,6 CM / INTERNAL DRAWER UNITS 48.6 CM DEEP

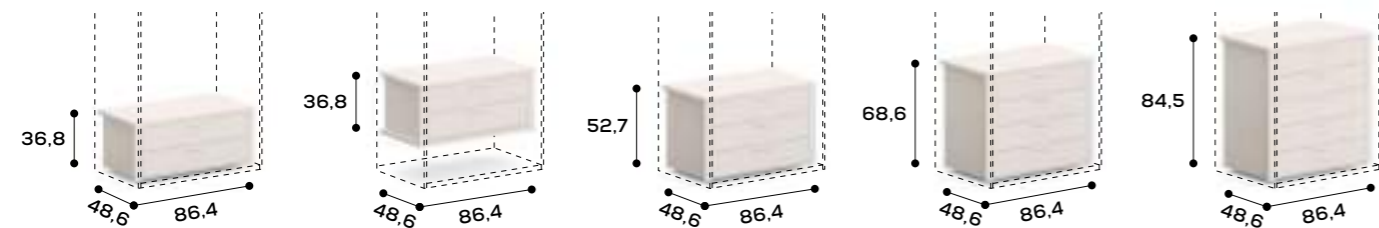

Posizionabili su vano intero. / Can be positioned to fill whole compartment.



ARMADI E MADIE WOODY / WOODY WARDROBES AND SIDEBOARDS

MADIE WOODY /
WOODY SIDEBOARDS



MANIGLIE HANDLES

La sezione dedicata alle maniglie propone un'ampia selezione, perfetta per arricchire gli ambienti con dettagli personalizzati. Disponibili in diverse forme e colori, permettono di aggiungere un tocco finale unico e distintivo a ogni complemento.

The handles section features an extensive selection, perfect for elevating interiors with personalized details. Available in a range of different shapes and colours, they're great for adding a unique and distinctive finishing touch to each complement.

15 MANIGLIE /
HANDLES



402 Maniglie /
Handles

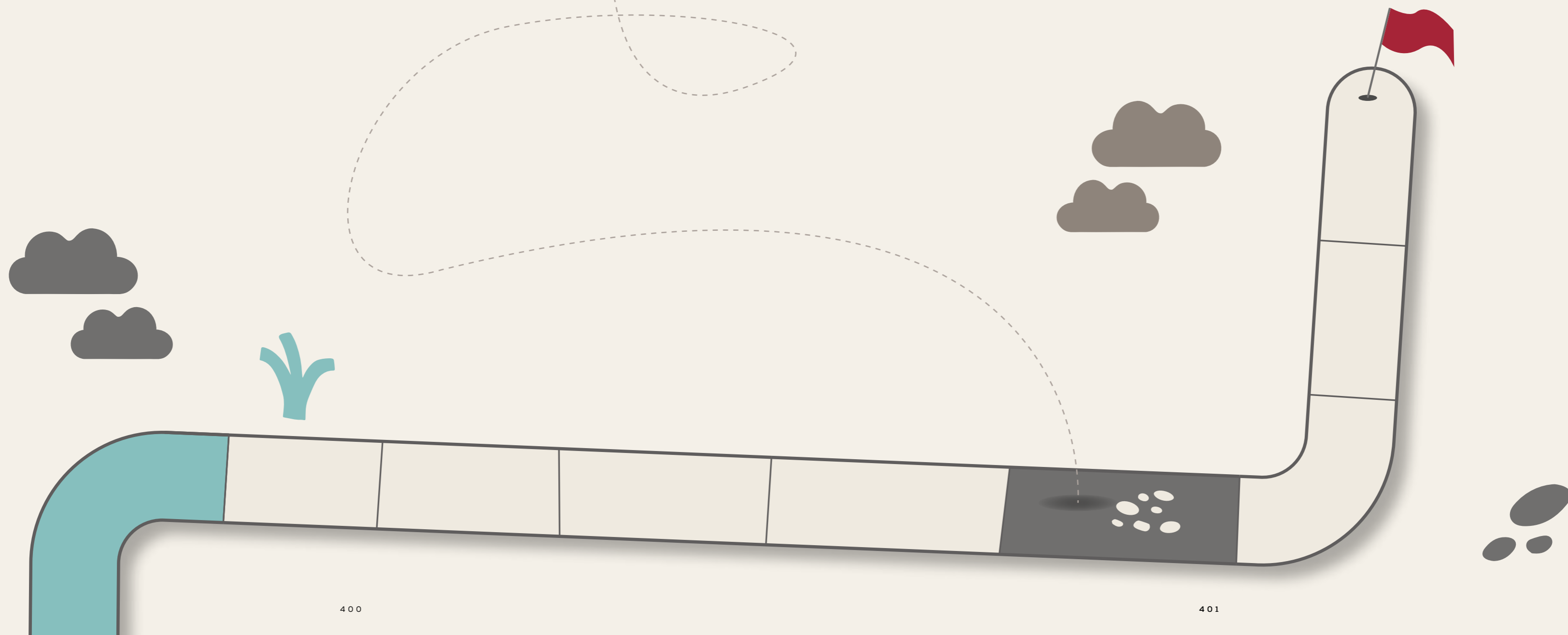

MANIGLIE / HANDLES



Out
Colori / Colours: 21



In
Colori / Colours: 19



OI
Colori / Colours: 19



Fefè
Colori / Colours: 19



Brick
Colori / Colours: 6



Arko
Colori / Colours: 19

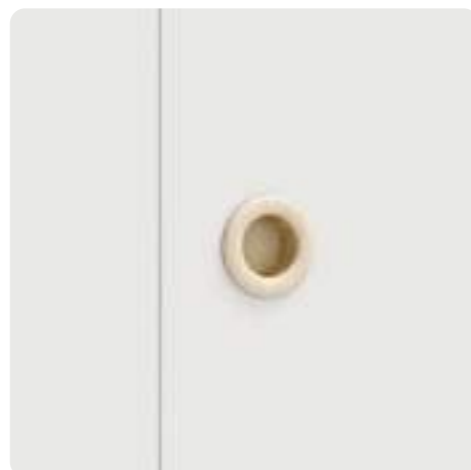

Atollo
Colori / Colours: 1



Pull
Colori / Colours: 6



Fefè L
Colori / Colours: 19

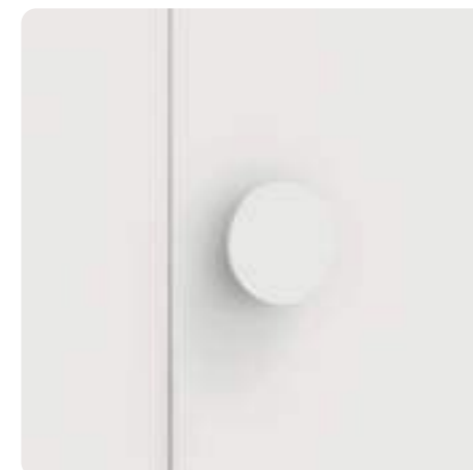

Dot
Colori / Colours: 6

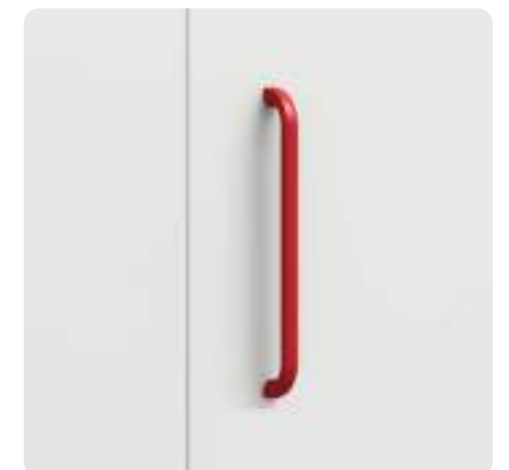

Arko L
Colori / Colours: 19

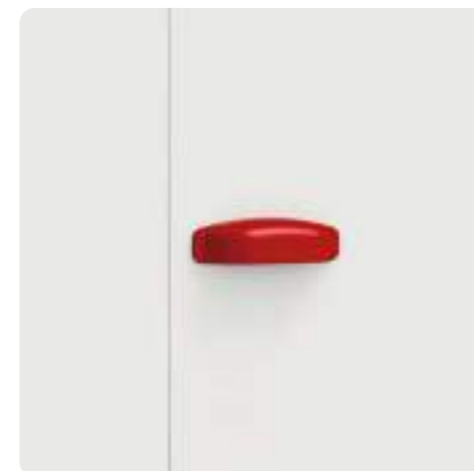

Shell
Colori / Colours: 19

MANIGLIE / HANDLES



Bridge
Colori / Colours: 7



Puzzle D40
Colori / Colours: 19

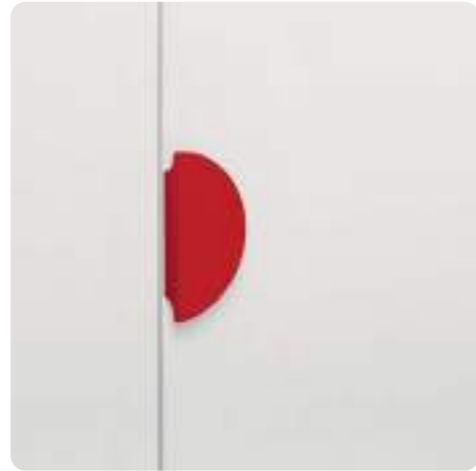

Puzzle D46
Colori / Colours: 19



Poddy D22
Colori / Colours: 7



Woody D12
Colori / Colours: 21



Woody D18
Colori / Colours: 21



Bridge L
Colori / Colours: 7



Puzzle D42
Colori / Colours: 19



Puzzle D48
Colori / Colours: 19



Poddy D24
Colori / Colours: 7



Woody D14
Colori / Colours: 21



Woody D16
Colori / Colours: 21

MANIGLIE / HANDLES



Stick
Colori / Colours: 6



Stick L
Colori / Colours: 6



Pinna
Colori / Colours: 22



Tab
Colori / Colours: 19



Stick XL
Colori / Colours: 6



Pinna XL
Colori / Colours: 22

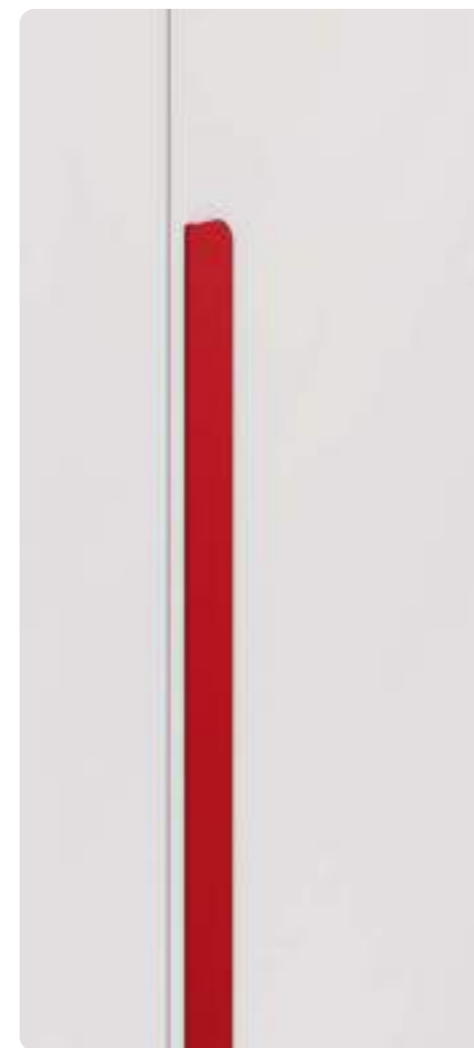

Tab XL
Colori / Colours: 19

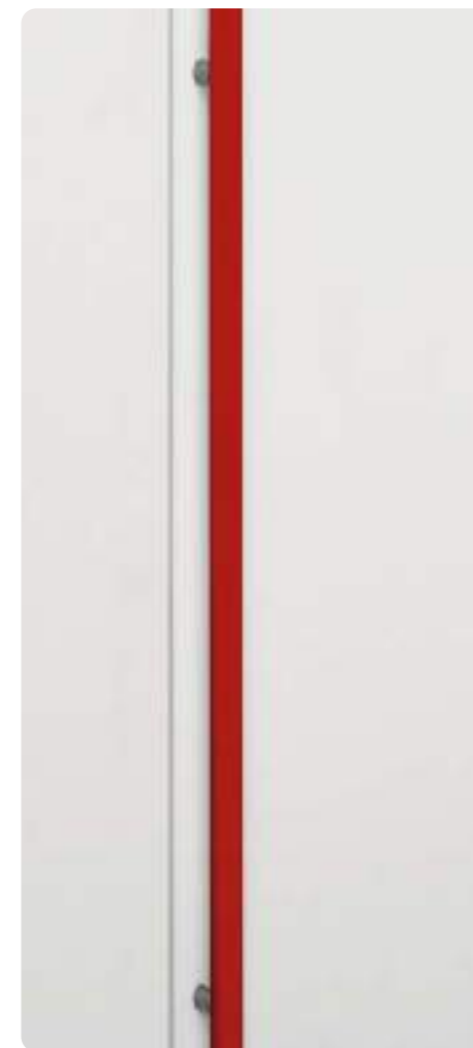

Ben
Colori / Colours: 19

MANIGLIE / HANDLES



Push-pull ante /
Push-to-open for doors



Push-pull cassetti /
Push-to-open for drawers

SERRATURE / LOCKS



Serratura cilindrica con cifratura differenziata /
Cylindrical lock keyed to differ



Serratura cifrata /
Combination lock



Serratura cilindrica /
Cylindrical lock

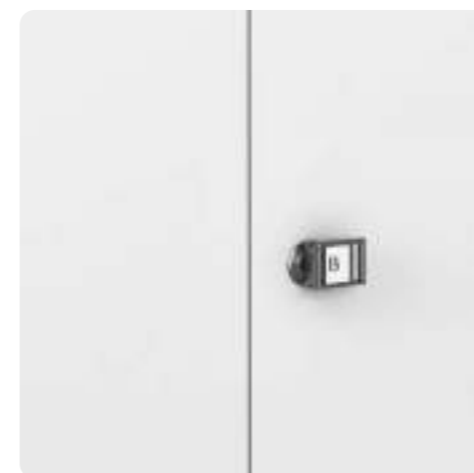

Serratura ad asta differenziata /
Espagnolette lock keyed to differ

concept and creative direction
Valeria Carlesso

communication concept and graphic design
grucciadesign.

project and set design
Nidi studio

digital images
Helios Digital

colour separation
Lucegroup

print
Ingrel Srl

January 2025



Battistella spa
via G. Galilei 35
31053 Pieve di Soligo
Treviso – Italia
T +39 0438 83 93
info@nidi.it



The mark of
responsible forestry

Richiedi a info@nidi.it se il prodotto a cui sei interessato è certificato FSC®.

Ask info@nidi.it if the product you are interested in is FSC® certified.

Battistella spa si riserva in qualsiasi momento la facoltà di apportare tutte le modifiche necessarie al miglioramento funzionale e qualitativo dei propri prodotti. Per ogni aspetto tecnico e dimensionale fare riferimento ai listini aziendali e relativi aggiornamenti. I colori e i materiali riprodotti nelle immagini stampate hanno un valore indicativo. Battistella spa declina ogni responsabilità derivante da eventuali inesattezze di stampa e/o da errori sulle caratteristiche dei prodotti forniti.

In line with its policy of improving product function and quality, Battistella spa reserves the right to make any necessary changes at any time. For information of a technical and dimensional nature, refer to the company price lists and relevant updates. The colours and materials reproduced in the images printed herein are given as an approximate guide only. Battistella spa does not accept any responsibility for misprints and/or mistakes in describing the characteristics of the products supplied.

