

A close-up, artistic photograph of a person's legs and feet. The person is wearing light-colored, textured socks and dark shoes. The image is softly lit, creating a warm and intimate atmosphere. The word "BLISS" is overlaid in the center in a bold, sans-serif font.

**BLISS**

BLISS —  
LA PERFEZIONE  
DELLA FORMA  
THE PERFECTION  
OF FORM

—  
DALLA MAESTRIA ARTIGIANA  
ALLA TECNOLOGIA INDUSTRIALE:  
UN PERFETTO EQUILIBRIO TRA  
TRADIZIONE E INNOVAZIONE  
PER CREARE SEDUTE DI DESIGN  
DAL FORTE IMPATTO ESTETICO,  
PENSATE PER OFFRIRE QUALITÀ  
E COMFORT IN OGNI AMBIENTE.  
—

FROM ARTISAN MASTERY  
TO INDUSTRIAL TECHNOLOGY:  
A PERFECT BALANCE BETWEEN  
TRADITION AND INNOVATION  
TO CREATE DESIGN SEATING  
WITH STRONG VISUAL IMPACT,  
CRAFTED TO OFFER QUALITY  
AND COMFORT IN EVERY SETTING.



**L'ESPERIENZA INCONTRA L'AMBIZIONE**



*"La struttura metallica realizzata con sapienza artigianale diventa l'anima rassicurante di ogni forma. Vuoti costruttivi pronti ad accogliere ciò che ancora non esiste."*

*"The metal structure, crafted with artisanal skill, becomes the reassuring soul of every shape. Constructive voids ready to embrace what does not yet exist."*





**LA TECNOLOGIA  
DELLO SCHIUMATO  
DIVENTA EMOZIONE**



**LE FINITURE CONOSCONO SOLTANTO  
UNA DIREZIONE: LA PERFEZIONE**



"Il materiale liquido si espande e prende forma nello stampo, un processo dove precisione e creatività danzano in armonia."

"The liquid material expands and takes shape in the mold, a process where precision and creativity dance in harmony."

"Dalla cura delle lavorazioni si percepisce la qualità del prodotto e si ottiene la perfezione dell'insieme."

"The precision of the workmanship reveals the product's quality and achieves the perfection of the whole."





**CARATTERE INDIPENDENTE,  
STILE DISTINTIVO**

"La scelta tessile e l'opzione dei basamenti non sono solo un dettaglio, ma un'opportunità di creare sedute uniche."

"The choice of textiles and the option of bases are not just details, but an opportunity to create unique seating."



**LA PERFEZIONE DELLA FORMA —  
THE PERFECTION OF FORM**



—  
TRE LINEE,  
TRE STILI,  
TRE CARATTERI

—  
THREE LINES,  
THREE STYLES,  
THREE CHARACTERS

SKY COLLECTION  
UN ABBRACCIO ALTO  
E ACCOGLIENTE  
A HIGH,  
COMFORTING HUG

16



KIM  
Tecnico pg. 78

20



YOKO + YOKO<sup>LOW</sup> + YOKO<sup>SMALL</sup>  
Tecnico pg. 79

24



BETTY  
Tecnico pg. 82

28



GINGER  
Tecnico pg. 83

32



WENDY + WENDY<sup>SMALL</sup>  
Tecnico pg. 84

**HALO COLLECTION**

SOFISTICATA  
E AVVOLGENTE

SOPHISTICATED  
AND EMBRACING

38



**PINKO**

Tecnico pg. 86

**QUADRA COLLECTION**

MODERNA E  
GEOMETRICA

MODERN AND  
GEOMETRIC

60



**TECLA**

Tecnico pg. 93

42



**CLOUD + CLOUD SMALL**

Tecnico pg. 87

46



**AGAVE**

Tecnico pg. 89

64



**KORA + KORA LOW + KORA SMALL**

Tecnico pg. 94

68



**BEA**

Tecnico pg. 97

50



**ALLEN + ALLEN SMALL**

Tecnico pg. 90

54



**OLLY**

Tecnico pg. 92

72



**DENVER**

Tecnico pg. 98

**KIM  
YOKO  
BETTY  
GINGER  
WENDY**





Due poltrone bicolor con base Rain colore wengè. Two two-tone armchairs with Rain base in wenge color.  
Poggiapiedi Act con base Rain Small colore wengè. Act footstool with Rain Small base in wenge color.

KIM

Poltrona con base Soft finitura nero opaco. Armchair with Soft base in matte black finish.  
Cuscini decoro cm 40x40. Decorative cushions 40x40 cm.

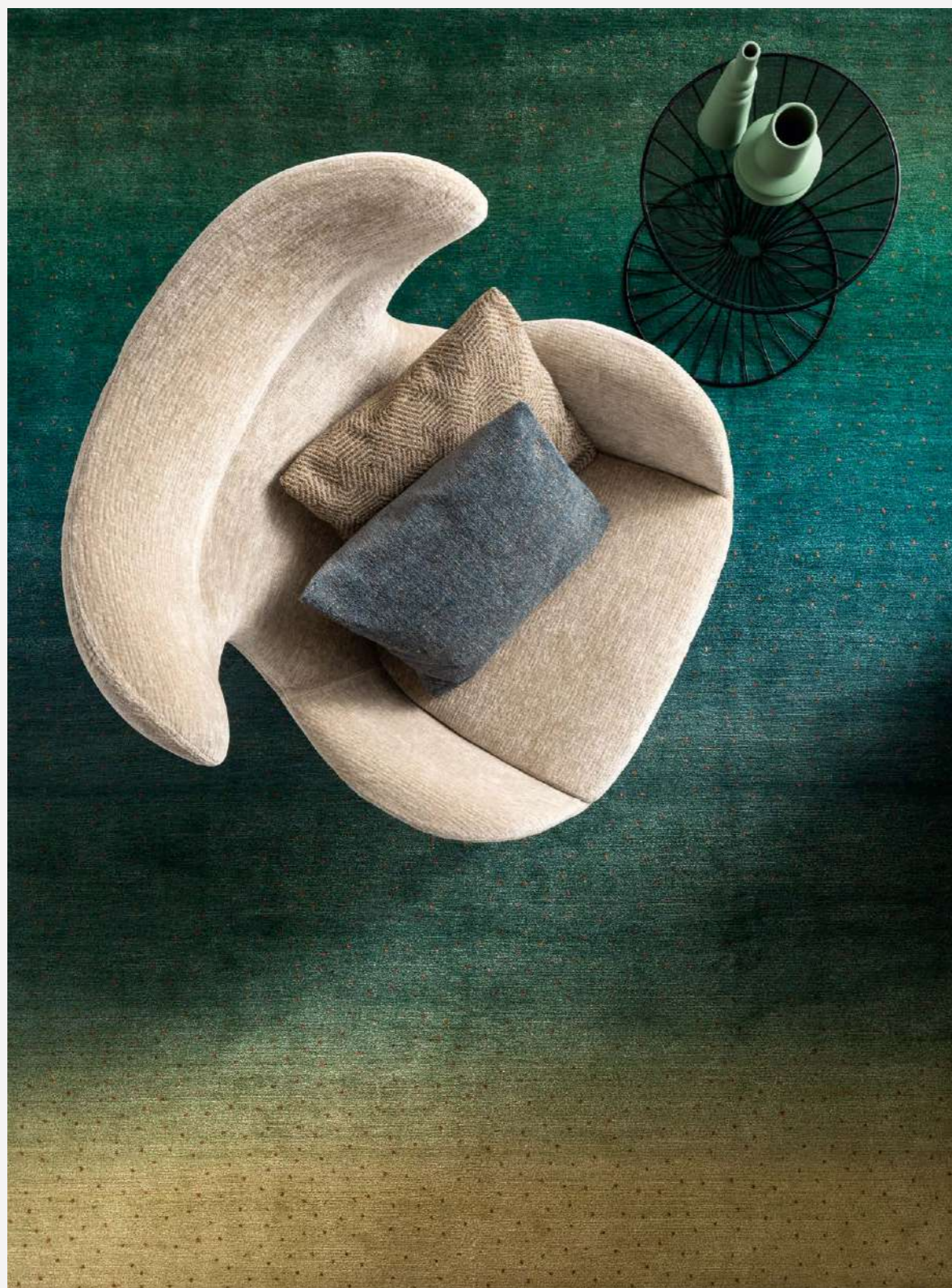



Poltrona Yoko con base Round finitura nero opaco. Yoko armchair with Round base in matte black finish.  
Poltrona Yoko Low con base Pop finitura nero opaco. Yoko Low armchair with Pop base in matte black finish.  
Poltrona Yoko Small con base Flip colore nero. Yoko Small armchair with Flip base in black color.  
Tavolino Air diametro cm 40. Air side table 40 cm diameter.

YOKO

Poltrona Yoko Low con base Blues colore naturale. Yoko Low armchair with Blues base in natural color.  
Accessorio Disk. Disk accessory.

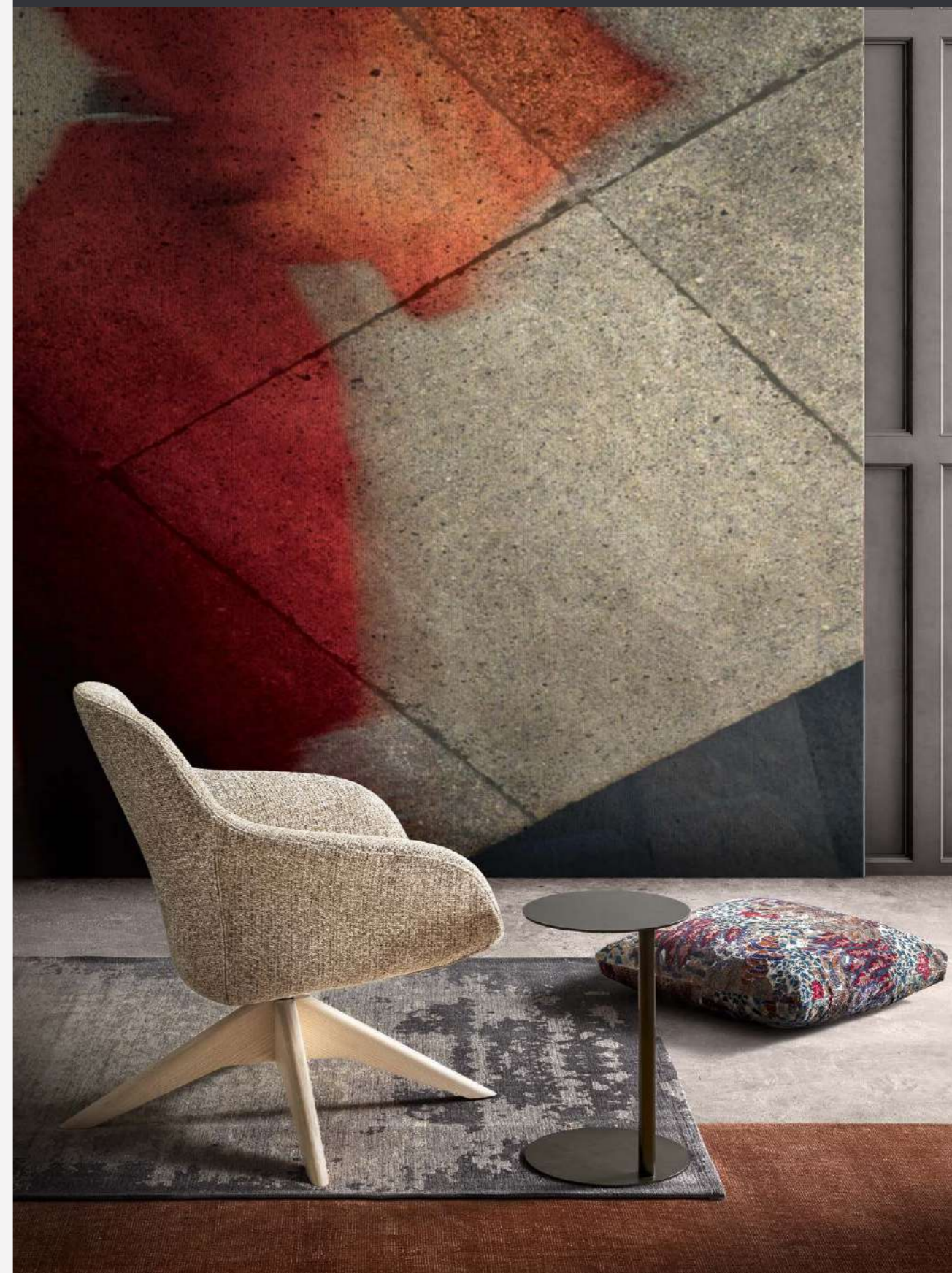

YOKO



Due poltrone (una bicolor) con base Rain colore wengè. Two armchairs (one two-tone) with Rain base in wenge color.  
Poggiapiedi Act con base Rain Small colore wengè. Act footstool with Rain Small base in wenge color.  
Pouff Big. Big pouf.  
Tavolino Air diametro cm 61. Air side table 61 cm diameter.

BETTY

Poltrona con base Round finitura manganese. Armchair with Round base in manganese finish.  
Cuscino decoro cm 50x50. Decorative cushion 50x50 cm.  
Tavolino Taki diametro cm 38. Taki side table 38 cm diameter.



BETTY



Due poltrone (una bicolor) con base Pop finitura nero opaco. Two armchairs (one two-tone) with Pop base in matte black finish.  
Poggiapiedi Act con base Pop Small finitura nero opaco. Act footstool with Pop Small base in matte black finish.  
Tavolino Air diametro cm 61. Air side table 61 cm diameter.

GINGER



Poltrona bicolor con base Blues colore wengè. Two-tone armchair with Blues base in wenge color.  
Cuscino decoro cm 40x40. Decorative cushion 40x40 cm.  
Pouff Big. Big pouf.

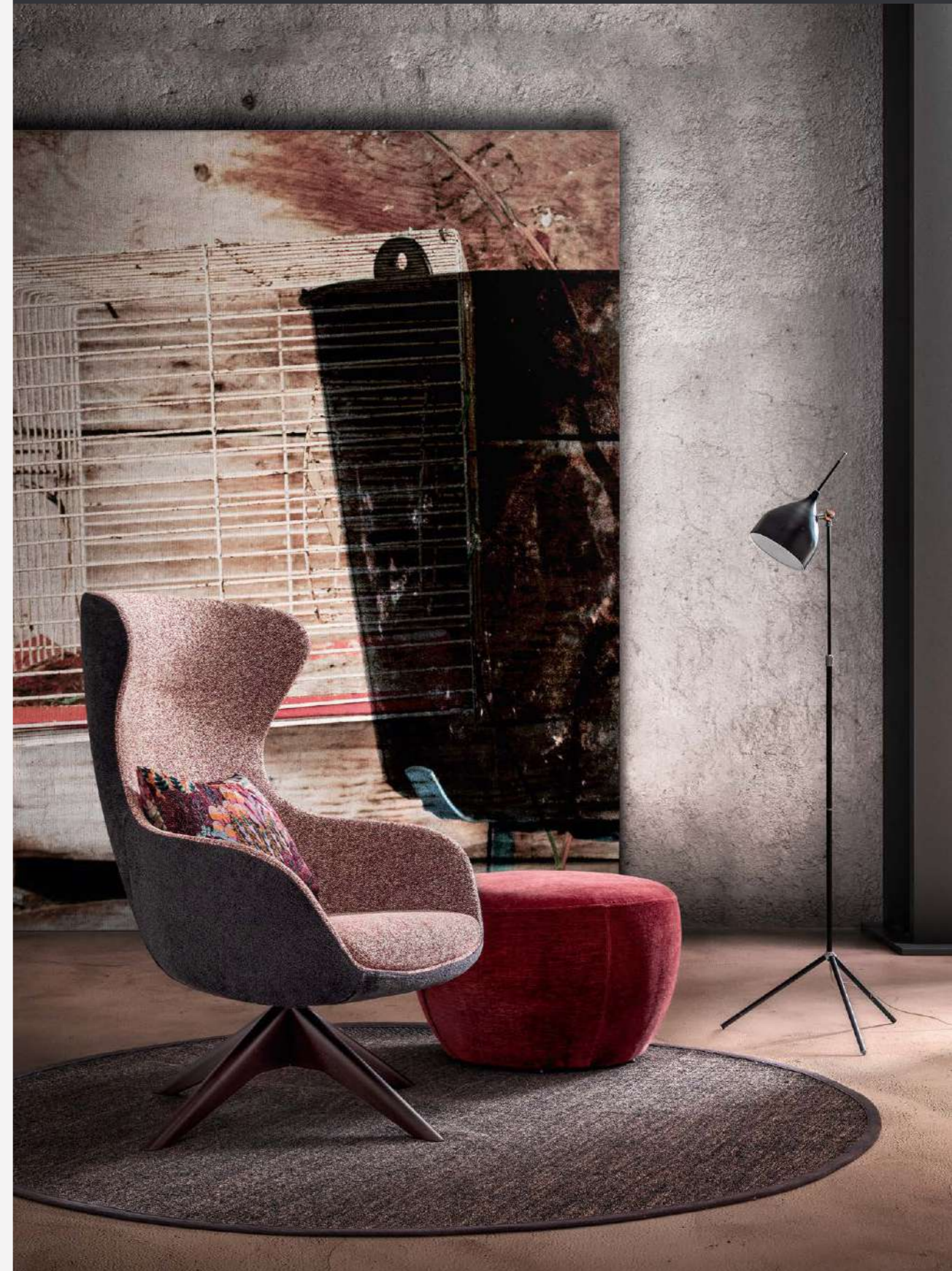

GINGER



Poltrona Wendy con base Blues colore wengè. Wendy armchair with Blues base in wenge color.  
Poltrona Wendy Small con base Jam Small finitura nero opaco. Wendy Small armchair with Jam Small base in matte black finish.  
Poltrona Wendy Small con base Twin colore wengè. Wendy Small armchair with Twin base in wenge color.  
Pouff Square. Square pouf.

WENDY

Poltrona con base Jam finitura nero opaco. Armchair with Jam base in matte black finish.  
Pouff Square. Square pouf.  
Tavolino Air diametro cm 40. Air side table 40 cm diameter.



WENDY

**PINKO  
CLOUD  
AGAVE  
ALLEN  
OLLY**





Tre poltrone (due con bordo a contrasto) con base Flo finitura nero opaco.  
Three armchairs (two with contrast trim) with Flo base in matte black finish.  
Cuscino rotondo diametro cm 40. Round cushion 40 cm diameter.  
Tavolino Air diametro cm 61. Air side table 61 cm diameter.

PINKO

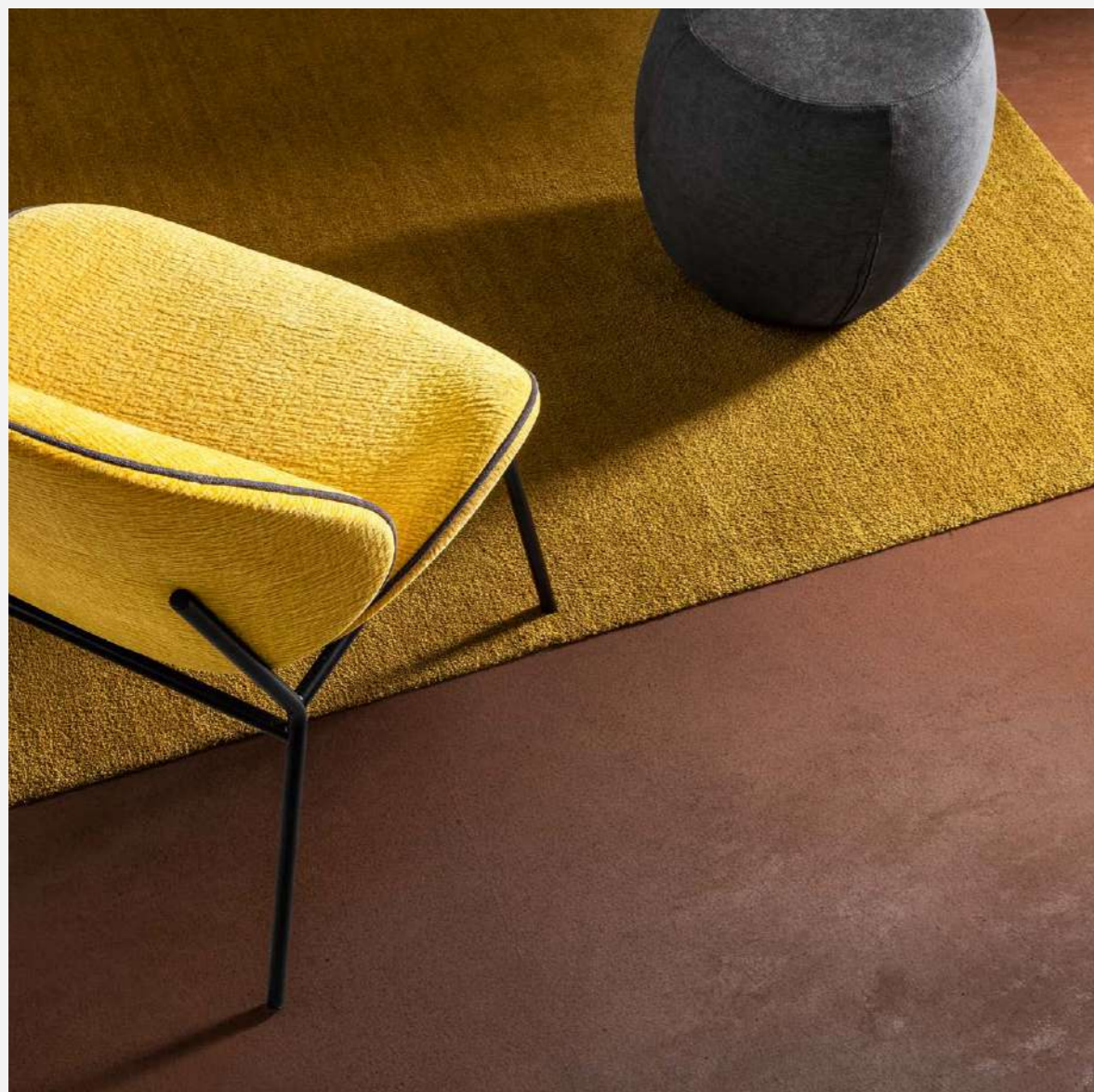

Poltrona con bordo a contrasto e con base Flo finitura nero opaco.  
Armchair with contrast trim and Flo base in matte black finish.  
Pouff Clove. Clove pouf.





Due poltrone Cloud (una bicolor) con base Hugo colore naturale. Two Cloud armchairs (one two-tone) with Hugo base in natural color.  
Poltrona Cloud Small con base Flip colore naturale. Cloud Small armchair with Flip base in natural color.  
Pouff Clove. Clove pouf.  
Tavolino Air diametro cm 40. Air side table 40 cm diameter.

CLOUD

Poltrona bicolor con base Round finitura nero opaco. Two-tone armchair with Round base in matte black finish.



CLOUD



Quattro poltrone (tre bicolore) con base Twin colore wengè. Four armchairs (three two-tone) with Twin base in wenge color.  
Cuscino rotondo diametro cm 40. Round cushion 40 cm diameter.

AGAVE



Poltrona con base Flip colore nero. Armchair with Flip base in black color.



AGAVE



Poltrona Allen con base End finitura nero opaco. Allen armchair with End base in matte black finish.  
Poltrona Allen Small con base End Small finitura nero opaco. Allen Small armchair with End Small base in matte black finish.  
Pouff Square. Square pouf.  
Tavolino Air diametro cm 61. Air side table 61 cm diameter.

ALLEN



Poltrona Allen bicolore con base End finitura nero opaco. Two-tone armchair with End base in matte black finish.  
Cuscino decoro cm 40x40. Decorative cushion 40x40 cm.



ALLEN



Tre poltrone con base Rain colore wengè. Three armchairs with Rain base in wenge color.  
Tavolino Air diametro cm 40. Air side table 40 cm diameter.

OLLY

Poltrona con base Pop finitura manganese. Armchair with Pop base in manganese finish.  
Cuscino decoro cm 40x40. Decorative cushion 40x40 cm.  
Pouff Square. Square pouf.  
Tavolino Level diametro cm 58 H cm 38. Level side table 58 cm diameter 38 cm height.

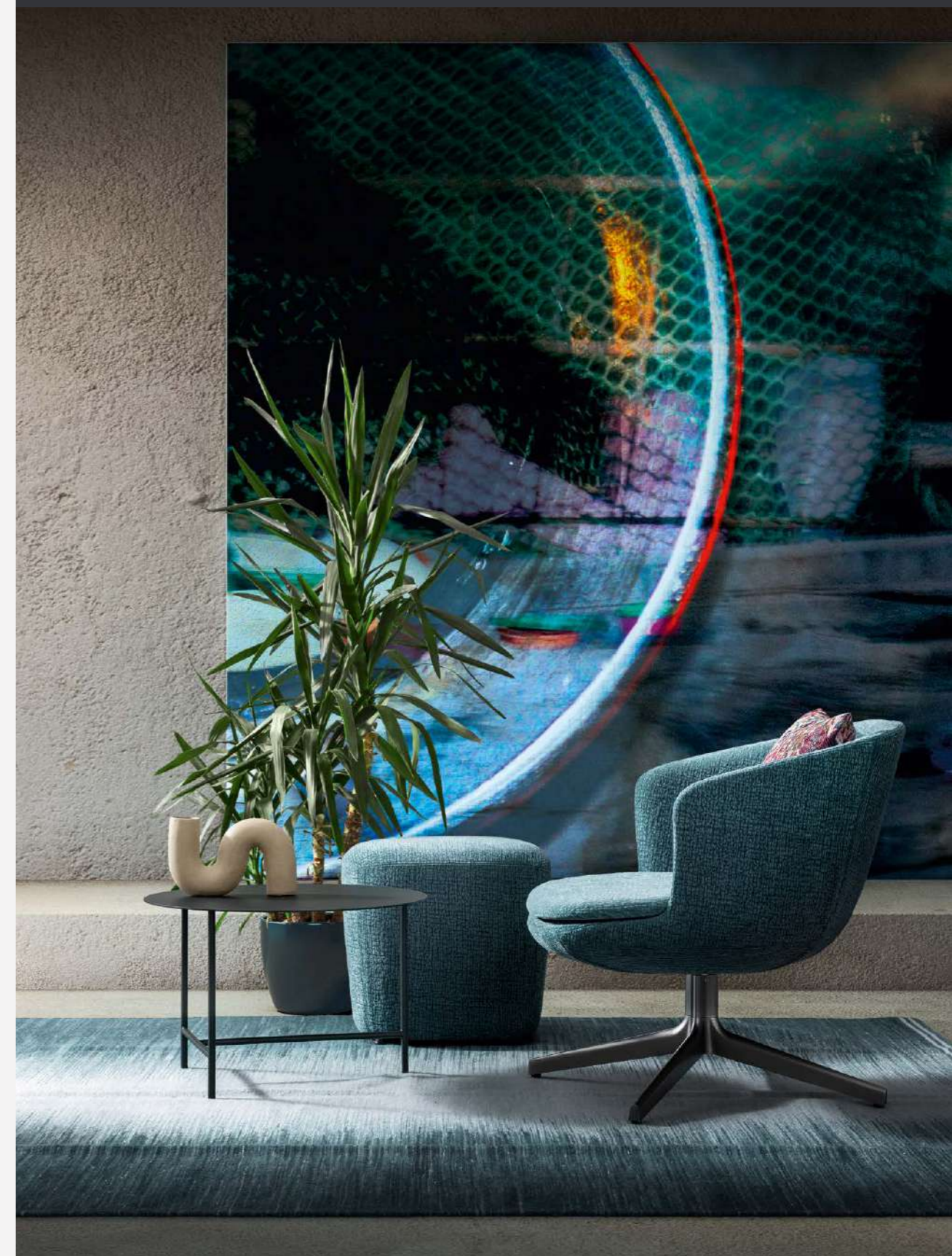

**TECLA  
KORA  
BEA  
DENVER**

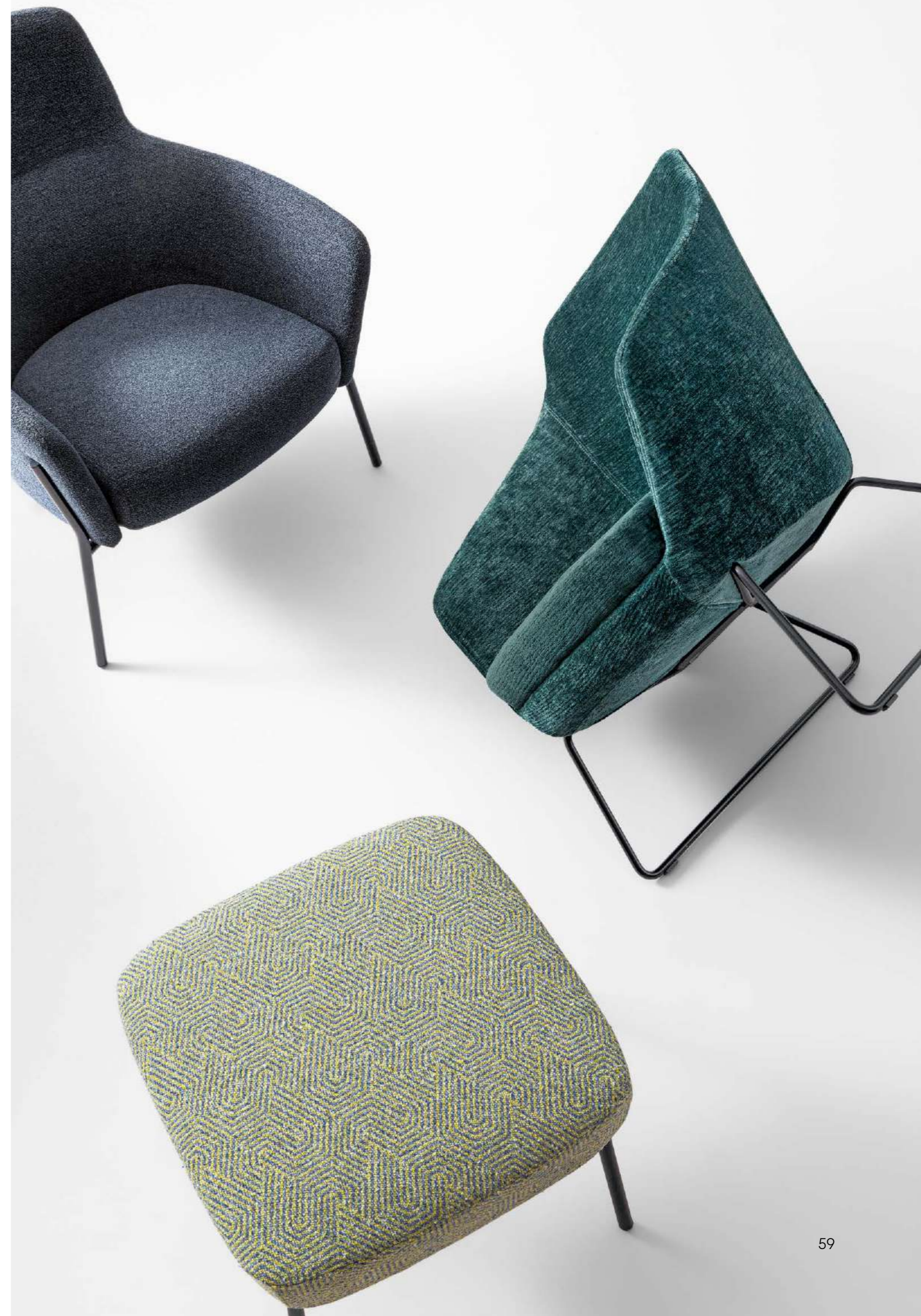



Due poltrone (una bicolor) con base Lot colore wengè. Two armchairs (one two-tone) with Lot base in wenge color.  
Pouff poggiapiedi End con base Lot Small colore wengè. End pouf footstool with Lot Small base in wenge color.

TECLA



Poltrona bicolor con base Soft finitura nero opaco. Two-tone armchair with Soft base in matte black finish.



TECLA



Poltrona Kora con base Round finitura nero opaco. Kora armchair with Round base in matte black finish.  
Poltrona Kora Low con base Zoe colore naturale. Kora Low armchair with Zoe base in natural color.  
Poltrona Kora Low con base Soft finitura nero opaco. Kora Low armchair with Soft base in matte black finish.  
Poltrona Kora Small con base Flip colore naturale. Kora Small armchair with Flip base in natural color.  
Cuscino decoro cm 40x40. Decorative cushion 40x40 cm.  
Pouff Big. Big pouf.

KORA

Poltrona Kora con base Zoe colore wengè. Kora armchair with Zoe base in wenge color.  
Cuscino decoro cm 50x50. Decorative cushion 50x50 cm.  
Tavolino Cross diametro cm 58 e cm 38. Cross side table diameters 58 cm and 38 cm.



KORA



Due poltrone con base Soft finitura nero opaco. Two armchairs with Soft base in matte black finish.  
Cuscino decoro cm 40x40. Decorative cushion 40x40 cm.  
Tavolino Air diametro cm 61. Air side table 61 cm diameter.

BEA

Poltrona con base Blues colore naturale. Armchair with Blues base in natural color.  
Pouff Square. Square pouf.  
Accessorio Disk. Disk accessory.



BEA



Tre poltrone con base Fresh finitura nero opaco. Three armchairs with Fresh base in matte black finish.  
Pouff poggiapiedi End con base Ice finitura nero opaco. End pouf footstool with Ice base in matte black finish.

DENVER

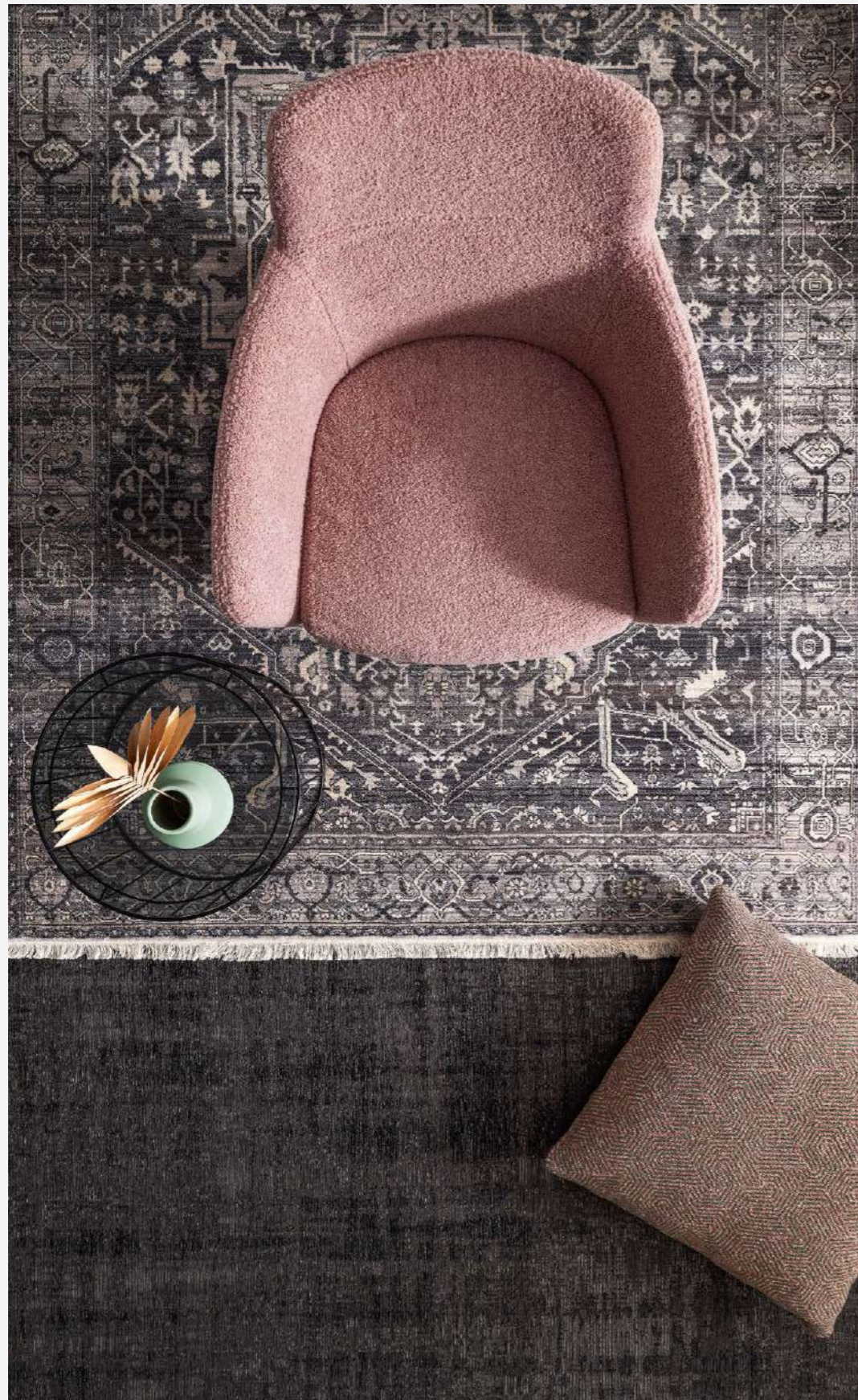

Poltrona con base Pop finitura manganese. Armchair with Pop base in manganese finish.  
Cuscino decoro cm 50x50. Decorative cushion 50x50 cm.  
Tavolino Air diametro cm 40. Air side table 40 cm diameter.



DENVER

—  
**TECNICO,  
DIMENSIONI  
& POSSIBILITA'**  
—

—  
TECHNICAL DETAILS,  
DIMENSIONS  
& POSSIBILITIES  
—



—  
LINEE ARMONIOSE,  
MATERIALI PREGIATI  
E DETTAGLI CURATI  
DEFINISCONO OGNI  
MODELLO,  
TRASFORMANDO  
OGNI SEDUTA  
IN UN'OASI  
DI COMFORT.  
SCEGLI IL  
PIACERE DI UN  
DESIGN CHE  
ACCOGLIE E ISPIRA.  
—

HARMONIOUS LINES,  
REFINED MATERIALS  
AND METICULOUS DETAILS  
DEFINE EVERY MODEL,  
TRANSFORMING  
EACH SEAT  
INTO AN OASIS  
OF COMFORT.  
EXPERIENCE DESIGN  
THAT WELCOMES  
AND INSPIRES.

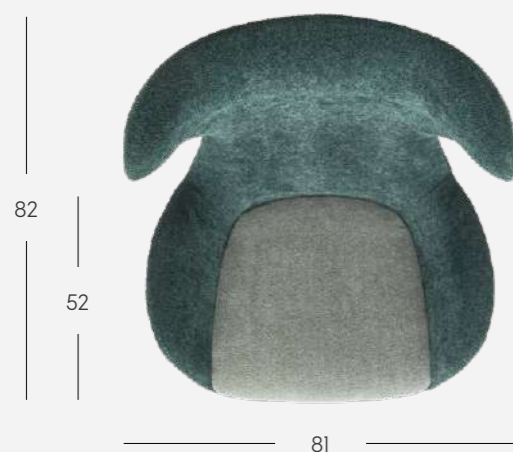

## KIM

**Struttura:** in metallo annegata in schiuma poliuretanic ignifuga densità media 60kg/mc, stampata a freddo; cuscino seduta in poliuretano espanso indeformabile densità media 60kg/mc.

Ignifuga secondo le seguenti normative:

- Classe IIM italiana: UNI9175/2010
- Classe francese: M4 (NFP 92-507:2004)
- California Technical Bulletin 117:2013, Section 3

**Rivestimento:** non sfoderabile in tessuto, ecopelle e pelle, possibilità bicolore.

**Base:**

- RAIN, di serie, in metallo con gambe coniche in legno colore wengè
- RAIN, optional, in metallo con gambe coniche in legno colore naturale
- SOFT, optional, in metallo finitura nero opaco
- BLUES girevole, optional, in metallo con gambe in legno colore wengè o naturale
- ROUND girevole, optional, in metallo finitura nero opaco o manganese.

**Structure:** Internal metal frame embedded in fire-retardant polyurethane foam, cold-moulded, with a medium density of 60 kg/m<sup>3</sup>. Seat cushion in non-deformable expanded polyurethane, medium density 60 kg/m<sup>3</sup>.

Fire-retardant according to the following standards:

- Italian Class IIM: UNI9175/2010
- French Class: M4 (NFP 92-507:2004)
- California Technical Bulletin 117:2013, Section 3

**Upholstery:** Non-removable cover, available in fabric, eco-leather, and leather; bicolour option available.

**Base:**

- RAIN, standard, metal with conical wooden legs in wenge wood colour
- RAIN, optional, metal with conical wooden legs in natural wood colour
- SOFT, optional, metal with matte black finish
- BLUES swivel, optional, metal with wooden legs in wenge or natural wood colour
- ROUND swivel, optional, metal with matte black or manganese finish.

**Base Base**

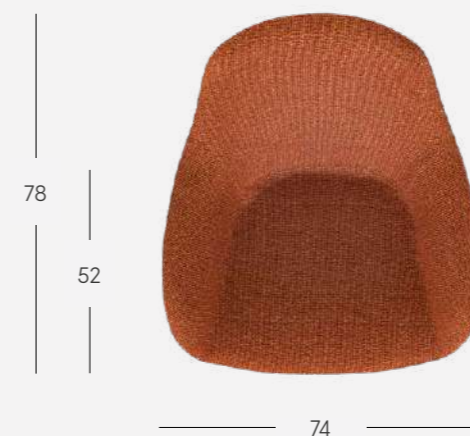
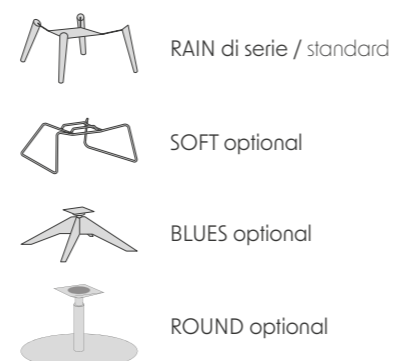

## YOKO

**Struttura:** in metallo annegata in schiuma poliuretanic ignifuga densità media 60kg/mc, stampata a freddo.

Ignifuga secondo le seguenti normative:

- Classe IIM italiana: UNI9175/2010
- Classe francese: M4 (NFP 92-507:2004)
- California Technical Bulletin 117:2013, Section 3

**Rivestimento:** non sfoderabile in tessuto, ecopelle e pelle, possibilità bicolore.

**Base:**

- BLUES girevole, di serie, in metallo con gambe in legno colore wengè
- BLUES girevole, optional, in metallo con gambe in legno colore naturale
- POP girevole, optional, in metallo finitura manganese, nero opaco o anodic bronze
- ROUND girevole, optional, in metallo finitura nero opaco o manganese.

**Structure:** Internal metal frame embedded in fire-retardant polyurethane foam, cold-moulded, with a medium density of 60 kg/m<sup>3</sup>.

Fire-retardant according to the following standards:

- Italian Class IIM: UNI9175/2010
- French Class: M4 (NFP 92-507:2004)
- California Technical Bulletin 117:2013, Section 3

**Upholstery:** Non-removable cover, available in fabric, eco-leather, and leather; bicolour option available.

**Base:**

- BLUES swivel, standard, metal with wooden legs in wenge wood colour
- BLUES swivel, optional, metal with wooden legs in natural wood colour
- POP swivel, optional, metal with manganese, matte black or anodic bronze finish
- ROUND swivel, optional, metal with matte black or manganese finish.

**Base Base**

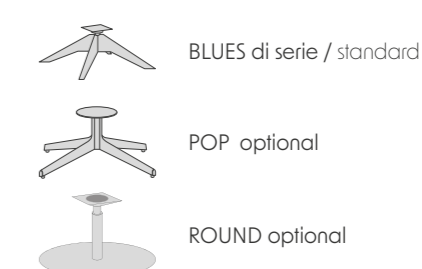



## YOKO LOW

**Struttura:** in metallo annegata in schiuma poliuretanic ignifuga densità media 60kg/mc, stampata a freddo.

Ignifuga secondo le seguenti normative:

- Classe IIM italiana: UNI9175/2010
- Classe francese: M4 (NFP 92-507:2004)
- California Technical Bulletin 117:2013, Section 3

**Rivestimento:** non sfoderabile in tessuto, ecopelle e pelle, possibilità bicolor.

**Base:**

- BLUES girevole, di serie, in metallo con gambe in legno colore wengè
- BLUES girevole, optional, in metallo con gambe in legno colore naturale
- POP girevole, optional, in metallo finitura manganese, nero opaco o anodic bronze
- ROUND girevole, optional, in metallo finitura nero opaco o manganese.

**Structure:** Internal metal frame embedded in fire-retardant polyurethane foam, cold-moulded, with a medium density of 60 kg/m<sup>3</sup>.

Fire-retardant according to the following standards:

- Italian Class IIM: UNI9175/2010
- French Class: M4 (NFP 92-507:2004)
- California Technical Bulletin 117:2013, Section 3

**Upholstery:** Non-removable cover, available in fabric, eco-leather, and leather; bicolour option available.

**Base:**

- BLUES swivel, standard, metal with wooden legs in wenge wood colour
- BLUES swivel, optional, metal with wooden legs in natural wood colour
- POP swivel, optional, metal with manganese, matte black or anodic bronze finish
- ROUND swivel, optional, metal with matte black or manganese finish.

**Base Base**



BLUES di serie / standard



POP optional



ROUND optional



## YOKO SMALL

**Struttura:** in schiuma poliuretanic ignifuga strutturale rigida, densità media 60kg/mc.

Ignifuga secondo le seguenti normative:

- Classe IIM italiana: UNI9175/2010
- Classe francese: M4 (NFP 92-507:2004)
- California Technical Bulletin 117:2013, Section 3

**Rivestimento:** non sfoderabile in tessuto, ecopelle e pelle, possibilità bicolor.

**Base:**

- FLIP, di serie, in metallo finitura nero opaco con gambe in legno colore nero
- FLIP, optional, in metallo finitura nero opaco con gambe in legno colore naturale.

**Structure:** In rigid structural fire-retardant polyurethane foam, medium density 60 kg/m<sup>3</sup>. Fire-retardant according to the following standards:

- Italian Class IIM: UNI9175/2010
- French Class: M4 (NFP 92-507:2004)
- California Technical Bulletin 117:2013, Section 3

**Upholstery:** Non-removable cover, available in fabric, eco-leather, and leather; bicolour option available.

**Base:**

- FLIP, standard, metal with matt black finish and black legs
- FLIP, optional, metal with matt black finish and natural wood legs.

**Base Base**



FLIP di serie / standard



## BETTY

**Struttura:** in metallo annegata in schiuma poliuretana ignifuga densità media 60kg/mc, stampata a freddo; cuscino seduta in poliuretano espanso indeformabile, densità media 60kg/mc.

Ignifuga secondo le seguenti normative:

- Classe IIM italiana: UNI9175/2010
- Classe francese: M4 (NFP 92-507:2004)
- California Technical Bulletin 117:2013, Section 3

**Rivestimento:** non sfoderabile in tessuto, ecopelle e pelle, possibilità bicolor.

**Base:**

- RAIN, di serie, in metallo con gambe coniche in legno colore wengè
- RAIN, optional, in metallo con gambe coniche in legno colore naturale
- ROUND girevole, optional, in metallo finitura nero opaco o manganese.

**Structure:** Internal metal frame embedded in fire-retardant polyurethane foam, cold-moulded, with a medium density of 60 kg/m<sup>3</sup>. Seat cushion in non-deformable expanded polyurethane, medium density 60 kg/m<sup>3</sup>.

Fire-retardant according to the following standards:

- Italian Class IIM: UNI9175/2010
- French Class: M4 (NFP 92-507:2004)
- California Technical Bulletin 117:2013, Section 3

**Upholstery:** Non-removable cover, available in fabric, eco-leather and leather; bicolour option available.

**Base:**

- RAIN, standard, metal with conical wooden legs in wenge colour
- RAIN, optional, metal with conical wooden legs in natural wood colour
- ROUND swivel, optional, metal with matte black or manganese finish.

**Base** Base



RAIN di serie / standard



ROUND optional

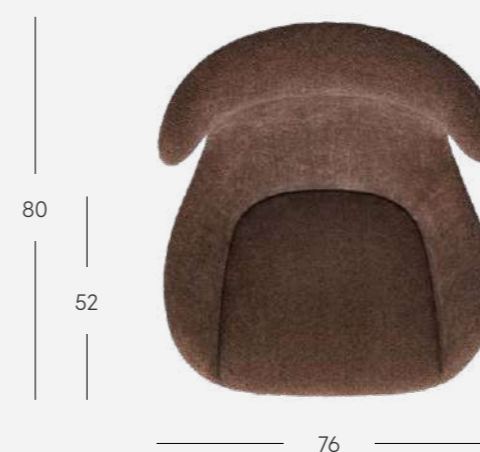

## GINGER

**Struttura:** in metallo annegata in schiuma poliuretana ignifuga densità media 60kg/mc, stampata a freddo; cuscino seduta in poliuretano espanso indeformabile, densità media 60kg/mc.

Ignifuga secondo le seguenti normative:

- Classe IIM italiana: UNI9175/2010
- Classe francese: M4 (NFP 92-507:2004)
- California Technical Bulletin 117:2013, Section 3

**Rivestimento:** non sfoderabile in tessuto, ecopelle e pelle, possibilità bicolor.

**Base:**

- RAIN, di serie, in metallo con gambe coniche in legno colore wengè
- RAIN, optional, in metallo con gambe coniche in legno colore naturale
- BLUES girevole, optional, in metallo con gambe in legno colore wengè o naturale
- POP girevole, optional, in metallo finitura nero opaco, manganese o anodic bronze.

**Structure:** Internal metal frame embedded in fire-retardant polyurethane foam, cold-moulded, with a medium density of 60 kg/m<sup>3</sup>. Seat cushion in non-deformable expanded polyurethane, medium density 60 kg/m<sup>3</sup>.

Fire-retardant according to the following standards:

- Italian Class IIM: UNI9175/2010
- French Class: M4 (NFP 92-507:2004)
- California Technical Bulletin 117:2013, Section 3

**Upholstery:** Non-removable cover, available in fabric, eco-leather and leather; bicolour option available.

**Base:**

- RAIN, standard, metal with conical wooden legs in wenge colour
- RAIN, optional, metal with conical wooden legs in natural wood colour
- BLUES swivel, optional, metal with wooden legs in wenge or natural wood colour
- POP swivel, optional, metal with matte black, manganese or anodic bronze finish.

**Base** Base



RAIN di serie / standard



BLUES optional



POP optional



## WENDY

**Struttura:** in metallo annegata in schiuma poliuretanic ignifuga densità media 60kg/mc, stampata a freddo; cuscino seduta in poliuretano schiumato stampato a freddo, con pacco molle ed inserto in legno.

Ignifuga secondo le seguenti normative:

- Classe IIM italiana: UNI9175/2010
- Classe francese: M4 (NFP 92-507:2004)
- California Technical Bulletin 117:2013, Section 3

**Rivestimento:** non sfoderabile in tessuto, ecopelle e pelle, possibilità bicolor.

**Base:**

- BLUES girevole, di serie, in metallo con gambe in legno colore wengè
- BLUES girevole, optional, in metallo con gambe in legno colore naturale
- WISH, optional, in legno colore wengè o naturale
- JAM, optional, in metallo finitura nero opaco.

**Structure:** Internal metal frame embedded in fire-retardant polyurethane foam, cold-moulded, with a medium density of 60 kg/m<sup>3</sup>.

Seat cushion in cold-molded polyurethane foam, with pocket spring unit and wooden insert.

Fire-retardant according to the following standards:

- Italian Class IIM: UNI9175/2010
- French Class: M4 (NFP 92-507:2004)
- California Technical Bulletin 117:2013, Section 3

**Upholstery:** Non-removable cover, available in fabric, eco-leather, and leather; bicolor option available.

**Base:**

- BLUES swivel, standard, metal with wooden legs in wenge
- BLUES swivel, optional, metal with wooden legs in natural wood colour
- WISH, optional, in wenge or natural-colored wood
- JAM, optional, metal with matte black finish.

**Base Base**

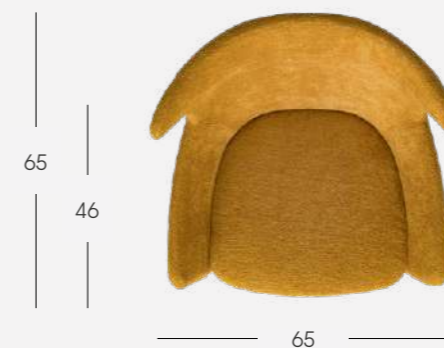

## WENDY SMALL

**Struttura:** in metallo annegata in schiuma poliuretanic ignifuga densità media 60kg/mc, stampata a freddo; cuscino seduta in poliuretano schiumato stampato a freddo.

Ignifuga secondo le seguenti normative:

- Classe IIM italiana: UNI9175/2010
- Classe francese: M4 (NFP 92-507:2004)
- California Technical Bulletin 117:2013, Section 3

**Rivestimento:** non sfoderabile in tessuto, ecopelle e pelle, possibilità bicolor.

**Base:**

- TWIN, di serie, in legno colore wengè
- TWIN, optional, in legno colore naturale
- JAM SMALL, optional, in metallo finitura nero opaco.

**Structure:** Internal metal frame embedded in fire-retardant polyurethane foam, cold-moulded, with a medium density of 60 kg/m<sup>3</sup>.

Cold-molded polyurethane foam seat cushion.

Fire-retardant according to the following standards:

- Italian Class IIM: UNI9175/2010
- French Class: M4 (NFP 92-507:2004)
- California Technical Bulletin 117:2013, Section 3

**Upholstery:** Non-removable cover, available in fabric, eco-leather, and leather; bicolor option available.

**Base:**

- TWIN, standard, in wenge-colored wood
- TWIN, optional, in natural-colored wood
- JAM SMALL, optional, metal with matte black finish

**Base Base**



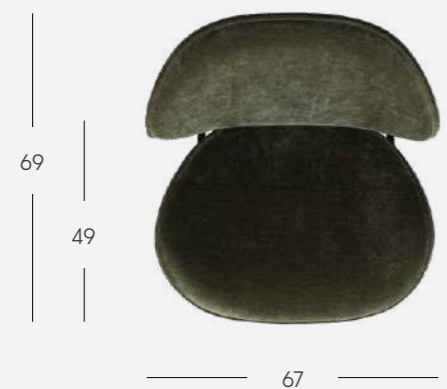

## PINKO

**Struttura:** in metallo annegata in schiuma poliuretanic ignifuga densità media 60kg/mc, stampata a freddo.

Ignifuga secondo le seguenti normative:

- Classe IIM italiana: UNI9175/2010
- Classe francese: M4 (NFP 92-507:2004)
- California Technical Bulletin 117:2013,Section 3

**Rivestimento:** non sfoderabile in tessuto e ecopelle, possibilità bicolor.

**Base:**

- FLO, di serie, in metallo finitura nero opaco.

**Structure:** Internal metal frame embedded in fire-retardant polyurethane foam, cold-moulded, with a medium density of 60 kg/m<sup>3</sup>.

Fire-retardant according to the following standards:

- Italian Class IIM: UNI9175/2010
- French Class: M4 (NFP 92-507:2004)- California Technical Bulletin 117:2013, Section 3

**Upholstery:** Non-removable cover, available in fabric and eco-leather; bicolour option available.

**Base:**

- FLO, standard, metal with matte black finish.

Base Base



FLO di serie



## CLOUD

**Struttura:** in metallo annegata in schiuma poliuretanic ignifuga densità media 60kg/mc, stampata a freddo; cuscino seduta in poliuretano espanso indeformabile densità media 60kg/mc.

Ignifuga secondo le seguenti normative:

- Classe IIM italiana: UNI9175/2010
- Classe francese: M4 (NFP 92-507:2004)
- California Technical Bulletin 117:2013,Section 3

**Rivestimento:** non sfoderabile in tessuto, ecopelle e pelle, possibilità bicolor.

**Base:**

- HUGO girevole, di serie, in metallo con gambe in legno colore wengè
- HUGO girevole, optional, in metallo con gambe in legno colore naturale
- POP girevole, optional, in metallo manganese, nero opaco o anodic bronze
- ROUND girevole, optional, in metallo finitura nero opaco o manganese

**Structure:** Internal metal frame embedded in fire-retardant polyurethane foam, cold-moulded, with a medium density of 60 kg/m<sup>3</sup>. Seat cushion in non-deformable expanded polyurethane, medium density 60 kg/m<sup>3</sup>.

Fire-retardant according to the following standards:

- Italian Class IIM: UNI9175/2010
- French Class: M4 (NFP 92-507:2004)
- California Technical Bulletin 117:2013, Section 3

**Upholstery:** Non-removable cover, available in fabric, eco-leather, and leather; bicolour option available.

**Base:**

- HUGO swivel, standard, metal with wooden legs in wenge wood colour
- HUGO swivel, optional, metal with wooden legs in natural wood colour
- POP swivel, optional, metal with manganese, matte black or anodic bronze finish
- ROUND swivel, optional, metal with matte black or manganese finish.

Base Base



HUGO di serie / standard



ROUND optional



POP optional

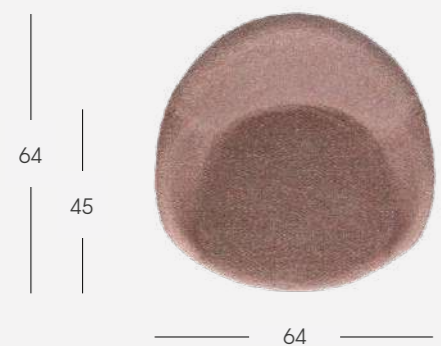

## CLOUD SMALL

**Struttura:** in metallo annegata in schiuma poliuretanic ignifuga densità media 60kg/mc, stampata a freddo.

Ignifuga secondo le seguenti normative:

- Classe IIM italiana: UNI9175/2010
- Classe francese: M4 (NFP 92-507:2004)
- California Technical Bulletin 117:2013, Section 3

**Rivestimento:** non sfoderabile in tessuto, ecopelle e pelle, possibilità bicolor.

**Base:**

- TWIN, di serie, in legno colore wengè
- TWIN, optional, in legno colore naturale
- FLIP, optional, in metallo finitura nero opaco con gambe in legno colore naturale o nero.

**Structure:** Internal metal frame embedded in fire-retardant polyurethane foam, cold-moulded, with a medium density of 60 kg/m<sup>3</sup>.

Fire-retardant according to the following standards:

- Italian Class IIM: UNI9175/2010
- French Class: M4 (NFP 92-507:2004)
- California Technical Bulletin 117:2013, Section 3

**Upholstery:** Non-removable cover, available in fabric, eco-leather, and leather; bicolour option available.

**Base:**

- TWIN, standard, in wenge-colored wood
- TWIN, optional, in natural-colored wood
- FLIP, optional, metal with matte black finish and natural or black colored wood legs.

**Base** Base



TWIN di serie / standard



FLIP optional

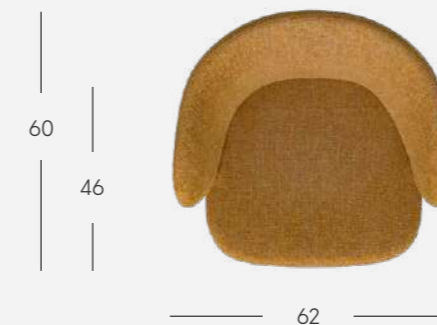

## AGAVE

**Struttura:** in metallo annegata in schiuma poliuretanic ignifuga densità media 60kg/mc, stampata a freddo.

Ignifuga secondo le seguenti normative:

- Classe IIM italiana: UNI9175/2010
- Classe francese: M4 (NFP 92-507:2004)
- California Technical Bulletin 117:2013, Section 3

**Rivestimento:** non sfoderabile in tessuto, ecopelle e pelle, possibilità bicolor.

**Base:**

- TWIN, di serie, in legno colore wengè
- TWIN, optional, in legno colore naturale
- FLIP, optional, in metallo finitura nero opaco con gambe in legno colore naturale o nero.

**Structure:** Internal metal frame embedded in fire-retardant polyurethane foam, cold-moulded, with a medium density of 60 kg/m<sup>3</sup>.

Fire-retardant according to the following standards:

- Italian Class IIM: UNI9175/2010
- French Class: M4 (NFP 92-507:2004)
- California Technical Bulletin 117:2013, Section 3

**Upholstery:** Non-removable cover, available in fabric, eco-leather, and leather; bicolour option available.

**Base:**

- TWIN, standard, in wenge-colored wood
- TWIN, optional, in natural-colored wood
- FLIP, optional, metal with matte black finish and natural or black colored wood legs.

**Base** Base



TWIN di serie / standard



FLIP optional

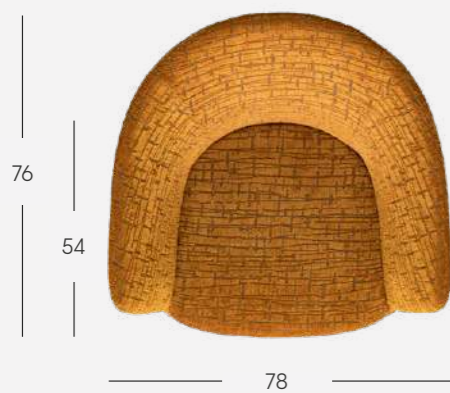

## ALLEN

**Struttura:** in metallo annegata in schiuma poliuretana ignifuga densità media 60kg/mc, stampata a freddo.

Ignifuga secondo le seguenti normative:

- Classe IIM italiana: UNI9175/2010
- Classe francese: M4 (NFP 92-507:2004)
- California Technical Bulletin 117:2013, Section 3

**Rivestimento:** non sfoderabile in tessuto, ecopelle e pelle, possibilità bicolor.

**Base:**

- END, di serie, in metallo finitura nero opaco

**Structure:** Internal metal frame embedded in fire-retardant polyurethane foam, cold-moulded, with a medium density of 60 kg/m<sup>3</sup>.

Fire-retardant according to the following standards:

- Italian Class IIM: UNI9175/2010
- French Class: M4 (NFP 92-507:2004)
- California Technical Bulletin 117:2013, Section 3

**Upholstery:** Non-removable cover, available in fabric, eco-leather and leather; bicolour option available.

**Base:**

- END, standard, metal with matte black finish.

**Base** Base



END di serie / standard



## ALLEN SMALL

**Struttura:** in schiuma poliuretana ignifuga densità media 60kg/mc, stampata a freddo.

Ignifuga secondo le seguenti normative:

- Classe IIM italiana: UNI9175/2010
- Classe francese: M4 (NFP 92-507:2004)
- California Technical Bulletin 117:2013, Section 3

**Rivestimento:** non sfoderabile in tessuto, ecopelle e pelle, possibilità bicolor.

**Base:**

- END SMALL, di serie, in metallo finitura nero opaco

**Structure:** in fire-retardant polyurethane foam, cold-moulded, with a medium density of 60 kg/m<sup>3</sup>.

Fire-retardant according to the following standards:

- Italian Class IIM: UNI9175/2010
- French Class: M4 (NFP 92-507:2004)
- California Technical Bulletin 117:2013, Section 3

**Upholstery:** Non-removable cover, available in fabric, eco-leather and leather; bicolour option available.

**Base:**

- END SMALL, standard, metal with matte black finish.

**Base** Base



END SMALL di serie / standard

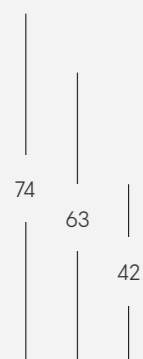

74

## OLLY

**Struttura:** in metallo annegata in schiuma poliuretana ignifuga densità media 60kg/mc, stampata a freddo; cuscino seduta in poliuretano espanso indeformabile densità media 60kg/mc.

Ignifuga secondo le seguenti normative:

- Classe IIM italiana: UNI9175/2010
- Classe francese: M4 (NFP 92-507:2004)
- California Technical Bulletin 117:2013, Section 3

**Rivestimento:** non sfoderabile in tessuto, ecopelle e pelle, possibilità bicolor.

**Base:**

- RAIN, di serie, in legno colore wengè
- RAIN, optional, in legno colore naturale
- BLUES girevole, optional, in metallo con gambe in legno colore wengè o naturale
- POP girevole, optional, in metallo finitura nero opaco, manganese o anodic bronze.

**Structure:** Internal metal frame embedded in fire-retardant polyurethane foam, cold-moulded, with a medium density of 60 kg/m<sup>3</sup>. Seat cushion in non-deformable expanded polyurethane, medium density 60 kg/m<sup>3</sup>.

Fire-retardant according to the following standards:

- Italian Class IIM: UNI9175/2010
- French Class: M4 (NFP 92-507:2004)
- California Technical Bulletin 117:2013, Section 3

**Upholstery:** Non-removable cover, available in fabric, eco-leather and leather; bicolour option available.

**Base:**

- RAIN, standard, in wenge-colored wood
- RAIN, optional, in natural-colored wood
- BLUES, swivel, optional, metal with wooden legs in wenge or natural wood colour
- POP swivel, optional, metal with matte black, manganese or anodic bronze finish.

**Base Base**



RAIN di serie / standard



BLUES optional



POP optional

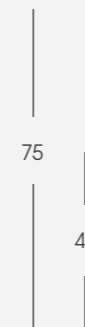

80

## TECLA

**Struttura:** in metallo annegata in schiuma poliuretana ignifuga densità media 60kg/mc, stampata a freddo; cuscino seduta e schienale in poliuretano indeformabile densità media 60kg/mc, stampati a freddo.

Ignifuga secondo le seguenti normative:

- Classe IIM italiana: UNI9175/2010
- Classe francese: M4 (NFP 92-507:2004)
- California Technical Bulletin 117:2013, Section 3

**Rivestimento:** non sfoderabile in tessuto, ecopelle e pelle, possibilità bicolor.

**Base:**

- LOT, di serie, piedi in legno colore wengè
- LOT, optional, piedi in legno colore naturale
- SOFT, optional, in metallo finitura nero opaco
- POP girevole, optional, in metallo finitura nero opaco, manganese o anodic bronze.

**Structure:** Internal metal frame embedded in fire-retardant polyurethane foam, cold-moulded, with a medium density of 60 kg/m<sup>3</sup>. Seat cushion and back cushion in non-deformable expanded polyurethane, medium density 60 kg/m<sup>3</sup>.

Fire-retardant according to the following standards:

- Italian Class IIM: UNI9175/2010
- French Class: M4 (NFP 92-507:2004)
- California Technical Bulletin 117:2013, Section 3

**Upholstery:** Non-removable cover, available in fabric, eco-leather and leather; bicolour option available.

**Base:**

- LOT, standard, in wenge-colored wood
- LOT, optional, in natural-colored wood
- SOFT, optional, metal with matte black finish
- POP, swivel, optional, metal with matte black, manganese or anodic bronze finish.

**Base Base**



LOT di serie / standard



SOFT optional



POP optional

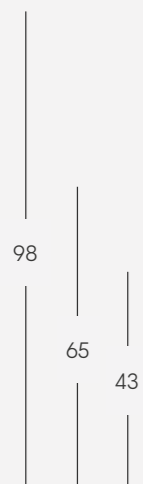

## KORA

**Struttura:** in metallo annegata in schiuma poliuretana ignifuga densità media 60kg/mc, stampata a freddo; cuscino seduta in poliuretano espanso indeformabile densità media 60kg/mc.

Ignifuga secondo le seguenti normative:

- Classe IIM italiana: UNI9175/2010
- Classe francese: M4 (NFP 92-507:2004)
- California Technical Bulletin 117:2013, Section 3

**Rivestimento:** non sfoderabile in tessuto, ecopelle e pelle, possibilità bicolor.

**Base:**

- SOFT, di serie, in metallo finitura nero opaco
- ZOE, optional, in metallo con gambe in legno colore wengè o naturale
- POP girevole, optional, in metallo finitura nero opaco, manganese o anodic bronze
- ROUND girevole, optional, in metallo finitura nero opaco o manganese.

**Structure:** Internal metal frame embedded in fire-retardant polyurethane foam, cold-moulded, with a medium density of 60 kg/m<sup>3</sup>. Seat cushion in non-deformable expanded polyurethane, medium density 60 kg/m<sup>3</sup>.

Fire-retardant according to the following standards:

- Italian Class IIM: UNI9175/2010
- French Class: M4 (NFP 92-507:2004)
- California Technical Bulletin 117:2013, Section 3

**Upholstery:** Non-removable cover, available in fabric, eco-leather, and leather; bicolour option available.

**Base:**

- SOFT, standard, metal with matte black finish
- ZOE, optional, metal with wooden legs in wenge or natural wood color
- POP swivel, optional, metal with matte black, manganese or anodic bronze finish
- ROUND swivel, optional, metal with matte black or manganese finish.

**Base Base**

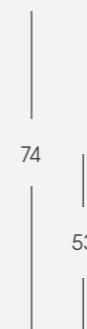
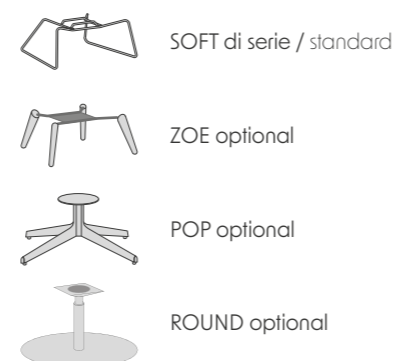

## KORA LOW

**Struttura:** in metallo annegata in schiuma poliuretana ignifuga densità media 60kg/mc, stampata a freddo; cuscino seduta in poliuretano espanso indeformabile densità media 60kg/mc.

Ignifuga secondo le seguenti normative:

- Classe IIM italiana: UNI9175/2010
- Classe francese: M4 (NFP 92-507:2004)
- California Technical Bulletin 117:2013, Section 3

**Rivestimento:** non sfoderabile in tessuto, ecopelle e pelle, possibilità bicolor.

**Base:**

- SOFT, di serie, in metallo finitura nero opaco
- ZOE, optional, in metallo con gambe in legno colore wengè o naturale
- POP girevole, optional, in metallo finitura nero opaco, manganese o anodic bronze
- ROUND girevole, optional, in metallo finitura nero opaco o manganese.

**Structure:** Internal metal frame embedded in fire-retardant polyurethane foam, cold-moulded, with a medium density of 60 kg/m<sup>3</sup>. Seat cushion in non-deformable expanded polyurethane, medium density 60 kg/m<sup>3</sup>.

Fire-retardant according to the following standards:

- Italian Class IIM: UNI9175/2010
- French Class: M4 (NFP 92-507:2004)
- California Technical Bulletin 117:2013, Section 3

**Upholstery:** Non-removable cover, available in fabric, eco-leather, and leather; bicolour option available.

**Base:**

- SOFT, standard, metal with matte black finish
- ZOE, optional, metal with wooden legs in wenge or natural wood color
- POP swivel, optional, metal with matte black, manganese or anodic bronze finish
- ROUND swivel, optional, metal with matte black or manganese finish.

**Base Base**

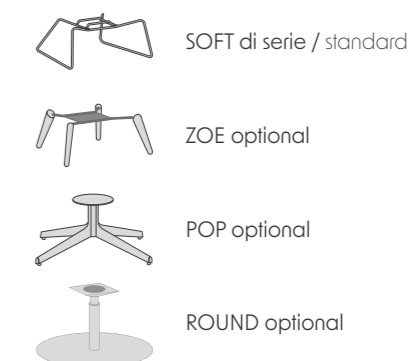

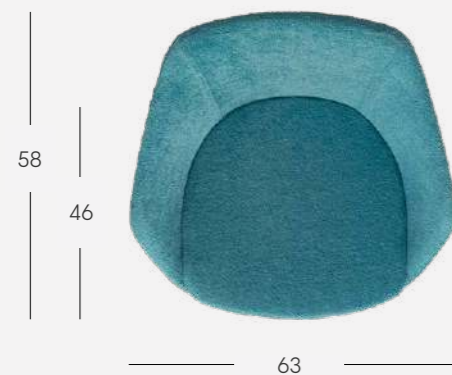

## KORA SMALL

**Struttura:** in metallo annegata in schiuma poliuretanic ignifuga densità media 60kg/mc, stampata a freddo; cuscino seduta in poliuretano espanso indeformabile densità 60kg/mc.

Ignifuga secondo le seguenti normative:

- Classe IIM italiana: UNI9175/2010
- Classe francese: M4 (NFP 92-507:2004)
- California Technical Bulletin 117:2013, Section 3

**Rivestimento:** non sfoderabile in tessuto, ecopelle e pelle, possibilità bicolor.

**Base:**

- STRIP, di serie, in legno colore wengè
- STRIP, optional, in legno colore naturale
- FLIP, optional, in metallo finitura nero opaco con gambe colore naturale o nero.

**Structure:** Internal metal frame embedded in fire-retardant polyurethane foam, cold-moulded, with a medium density of 60 kg/m<sup>3</sup>. Seat cushion in non-deformable expanded polyurethane, medium density 60 kg/m<sup>3</sup>.

Fire-retardant according to the following standards:

- Italian Class IIM: UNI9175/2010
- French Class: M4 (NFP 92-507:2004)
- California Technical Bulletin 117:2013, Section 3

**Upholstery:** Non-removable cover, available in fabric, eco-leather and leather; bicolour option available.

**Base:**

- STRIP, standard, in wenge-colored wood
- STRIP, optional, in natural-colored wood
- FLIP, optional, metal with matte black finish and natural wood or black legs.

**Base Base**



STRIP di serie / standard



FLIP optional



## BEA

**Struttura:** in metallo annegata in schiuma poliuretanic ignifuga densità media 60kg/mc, stampata a freddo.

Ignifuga secondo le seguenti normative:

- Classe IIM italiana: UNI9175/2010
- Classe francese: M4 (NFP 92-507:2004)
- California Technical Bulletin 117:2013, Section 3

**Rivestimento:** non sfoderabile in tessuto, ecopelle e pelle, possibilità bicolor.

**Base:**

- SOFT, di serie, in metallo finitura nero opaco
- BLUES girevole, optional, in metallo con gambe in legno colore wengè o naturale.

**Structure:** Internal metal frame embedded in fire-retardant polyurethane foam, cold-moulded, with a medium density of 60 kg/m<sup>3</sup>.

Fire-retardant according to the following standards:

- Italian Class IIM: UNI9175/2010
- French Class: M4 (NFP 92-507:2004)
- California Technical Bulletin 117:2013, Section 3

**Upholstery:** Non-removable cover, available in fabric, eco-leather, and leather; bicolour option available.

**Base:**

- SOFT, standard, metal with matte black finish
- BLUES swivel, optional, metal with wooden legs in wenge or natural wood colour.

**Base Base**



SOFT di serie / standard



BLUES optional

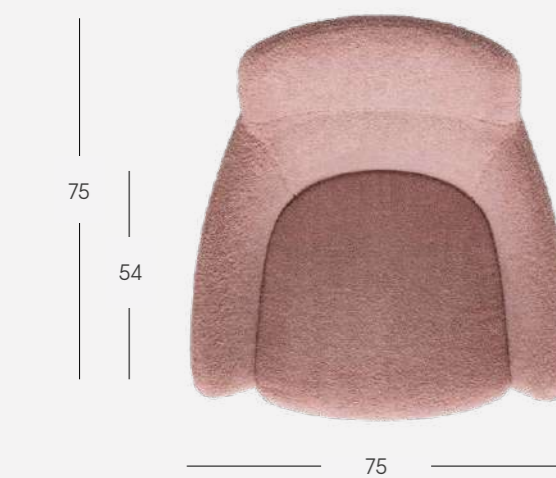

## DENVER

**Struttura:** in metallo annegata in schiuma poliuretana ignifuga densità media 60kg/mc, stampata a freddo; cuscino seduta in poliuretano schiumato stampato a freddo, con pacco molle e inserto in legno.

Ignifuga secondo le seguenti normative:

- Classe IIM italiana: UNI9175/2010
- Classe francese: M4 (NFP 92-507:2004)
- California Technical Bulletin 117:2013, Section 3

**Rivestimento:** non sfoderabile in tessuto, ecopelle e pelle, possibilità bicolor.

**Base:**

- BLUES girevole, di serie, in metallo con gambe in legno colore wengè
- BLUES girevole, optional, in metallo con gambe in legno colore naturale
- FRESH, optional, in metallo finitura nero opaco
- POP girevole, optional, in metallo finitura nero opaco, manganese o anodico bronze.

**Structure:** Internal metal frame embedded in fire-retardant polyurethane foam, cold-moulded, with a medium density of 60 kg/m<sup>3</sup>. Seat cushion in cold-molded polyurethane foam, with pocket spring unit and wooden insert.

Fire-retardant according to the following standards:

- Italian Class IIM: UNI9175/2010
- French Class: M4 (NFP 92-507:2004)
- California Technical Bulletin 117:2013, Section 3

**Upholstery:** Non-removable cover, available in fabric, eco-leather, and leather; bicolour option available.

**Base:**

- BLUES swivel, standard, metal with wooden legs in wenge wood colour
- BLUES swivel, optional, metal with wooden legs in natural wood colour
- FRESH, optional, metal with matte black finish
- POP swivel, optional, metal with matte black, manganese or anodico bronze finish.

**Base Base**



**Base Base**

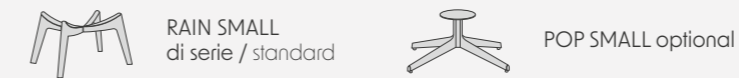

**Base Base**

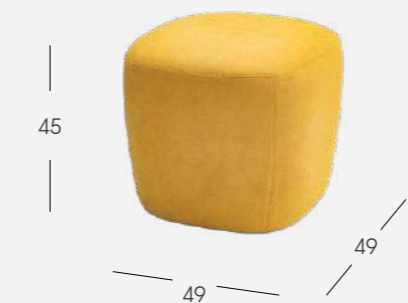

## ACT POGGIPIEDI

**Struttura:** in metallo annegata in schiuma poliuretana ignifuga densità media 60kg/mc, stampata a freddo.

**Rivestimento:** non sfoderabile in tessuto, ecopelle e pelle.

**Base:**

- RAIN SMALL, di serie, piedi in legno colore wengè; optional, piedi in legno colore naturale
- POP SMALL girevole, optional, in metallo finitura nero opaco, manganese o anodico bronze.

**Structure:** Internal metal frame embedded in fire-retardant polyurethane foam, cold-moulded, with a medium density of 60 kg/m<sup>3</sup>.

**Upholstery:** Non-removable cover, available in fabric, eco-leather, and leather.

**Base:**

- RAIN SMALL, standard, in wenge-colored wood; optional, in natural-colored wood
- POP SMALL swivel, optional, metal with matte black, manganese or anodico bronze finish.

## END POGGIPIEDI

**Struttura:** schiuma poliuretana ignifuga densità media 60kg/mc, stampata a freddo con inserto in legno.

**Rivestimento:** non sfoderabile in tessuto, ecopelle e pelle.

**Base:**

- ICE, di serie, in metallo finitura nero opaco
- LOT SMALL, optional, piedi in legno colore wengè o naturale
- POP SMALL girevole, optional, in metallo finitura nero opaco, manganese o anodico bronze.

**Structure:** Internal metal frame embedded in fire-retardant polyurethane foam, cold-moulded, with a medium density of 60 kg/m<sup>3</sup>.

**Upholstery:** Non-removable cover, available in fabric, eco-leather and leather.

**Base:**

- ICE, standard, metal with matte black
- LOT SMALL optional, in wenge-colored wood
- POP SMALL swivel, optional, metal with matte black, manganese or anodico bronze finish.

## SQUARE POUFF

**Struttura:** in metallo annegata in schiuma poliuretana ignifuga densità media 60kg/mc, stampata a freddo.

**Rivestimento:** non sfoderabile in tessuto, ecopelle e pelle.

**Piedi:** Abs.

**Structure:** Internal metal frame embedded in fire-retardant polyurethane foam, cold-moulded, with a medium density of 60 kg/m<sup>3</sup>.

**Upholstery:** Non-removable cover, available in fabric, eco-leather and leather.

**Foot:** Abs.

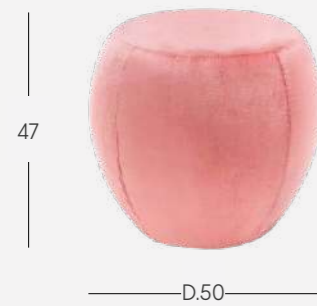

## CLOVE POUFF

**Struttura:** in metallo annegata in schiuma poliuretanic ignifuga densità media 60kg/mc, stampata a freddo.

**Rivestimento:** non sfoderabile in tessuto, ecopelle e pelle.

**Piedi:** Abs.

**Structure:** Internal metal frame embedded in fire-retardant polyurethane foam, cold-moulded, with a medium density of 60 kg/m<sup>3</sup>.

**Upholstery:** Non-removable cover, available in fabric, eco-leather and leather.

**Foot:** Abs.

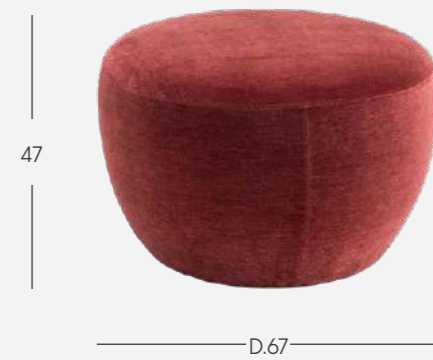

## BIG POUFF

**Struttura:** in metallo annegata in schiuma poliuretanic ignifuga densità media 60kg/mc, stampata a freddo.

**Rivestimento:** non sfoderabile in tessuto, ecopelle e pelle.

**Piedi:** Abs.

**Structure:** Internal metal frame embedded in fire-retardant polyurethane foam, cold-moulded, with a medium density of 60 kg/m<sup>3</sup>.

**Upholstery:** Non-removable cover, available in fabric, eco-leather and leather.

**Foot:** Abs.

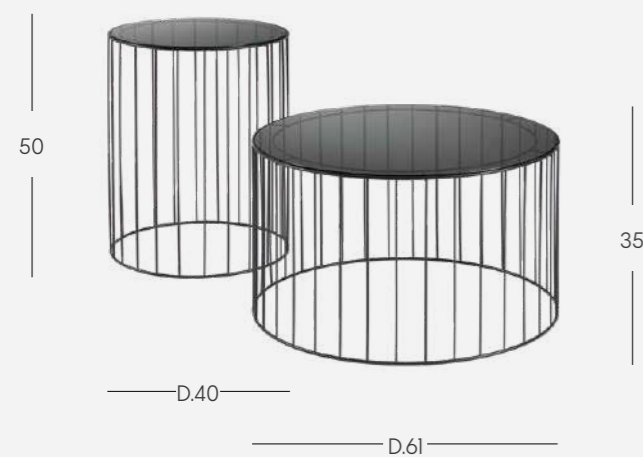

## AIR TAVOLINO

**Struttura:** in tondino di ferro finitura nero opaco con piano in vetro temperato colore grigio fumè.

**Structure:** round iron rod in matte black finish, topped with tempered painted glass in smoked grey.



## STICK TAVOLINO

**Struttura:** in tondino di ferro e ripiano finitura nero opaco.

**Structure:** round iron rod with top in matte black finish.

## CROSS TAVOLINO

**Struttura:** in metallo verniciato finitura nero opaco o manganese.

**Structure:** painted metal in matte black or manganese finish.

## TRAY TAVOLINO

**Struttura:** in metallo verniciato finitura nero opaco o manganese.

**Structure:** painted metal in matte black or manganese finish.

CREDITS:

Design  
Centro stile Samoa, Treviso

Photo, 3D, styling & graphic design  
[www.linkfoto.it](http://www.linkfoto.it)

Print  
Grafiche Antiga



stampato  
con il sole

Le opere visive sullo sfondo sono tratte  
dal progetto "Tales of Mutation" di  
Alice Brazziti e René Harari Masri.

The visual works in the background are  
from the project "Tales of Mutation" by  
Alice Brazziti and René Harari Masri.

**SAMOA**<sup>®</sup>  
DIVANI E IMBOTTITI

**SAMOA SRL**

31014 Colle Umberto (TV) - ITALY  
Via 1° Maggio, 9/11 (Z.I.)

Tel. +39 0438 388179

[www.samoativani.com](http://www.samoativani.com)  
[info@samoativani.com](mailto:info@samoativani.com)



SAMOA produce con energia pulita.  
SAMOA produces with clean energy.



SAMOA produce esclusivamente in Italia.  
SAMOA produces exclusively in Italy.



SAMOA<sup>®</sup>  
DIVANI E IMBOTTITI