

experience.

FORME CHE DISEGNANO EMOZIONI

**Inconfondibile proposta di modelli
estremamente personalizzabili ideati per
realizzare esclusivi progetti abitativi.**

UNMISTAKABLE OFFER OF EXTREMELY
CUSTOMIZABLE MODELS, CREATED IN ORDER
TO REALIZE UNIQUE LIVING PROJECTS.

index.



ginny. 06
INFO TECNICHE PG 142



sassy. 20
INFO TECNICHE PG 156



isla. 32
INFO TECNICHE PG 144



blank.minimal/open 46
INFO TECNICHE PG 138



dafne. 66
INFO TECNICHE PG 140



ares. 74
INFO TECNICHE PG 136



jack.tidy/top 86
INFO TECNICHE PG 146



madison. 98
INFO TECNICHE PG 152



nixon. 108
INFO TECNICHE PG 154



living. bright/chic/minimal 116
INFO TECNICHE PG 148





**Benessere e relax,
le condizioni primarie
del design.**

/ Wellness and relax,
design's priority.





**Per vivere il comfort
intensamente.**

Divano laterale cm 180
sx e panchetta dx con
schiena Comfort.

/ Living the comfort
to the fullest.

Lateral sofa cm 180 lh
and bench rh with
Comforts backrest.





**Accostamenti cromatici
che regalano emozioni
da ogni prospettiva.**

/ Chromatic combinations
that bring out emotions
from any perspective.





sassy.

Due centrali cm 83x103, centrale cm 83x166, pouff cm 83x63 e due braccioli H cm 75
/ Two central elements cm 83x103, central element cm 83x166, pouf cm 83x63 and two armrests H cm 75
Cuscini Soft cm 50x50, cm 65x45 e cm 40x40 / Soft cushions cm 50x50, cm 65x45 and cm 40x40
Tavolino contenitore / Storage coffee table

20 / 21





**Scelta esclusiva
per una nuova
interpretazione
del relax.**
/ A unique choice
for a new relax
interpretation.







**Dinamicità e versatilità
compositiva per
soluzioni inaspettate.**

/ Dynamicity and
compositional
versatility for
unexpected solutions.





**Sistema modulare a
componibilità libera.**
/ Free modularity system.



Struttura cm 180 con pacchetto schiena cm 70 e pacchetto bracciolo alto,
struttura cm 180 con due pacchetti schiena cm 70, struttura Esa con pacchetto schiena cm 70
/ Structure cm 180 with backrest pack cm 70 and high armrest pack, structure cm 180
with two backrest packs cm 70, Esa structure with backrest pack cm 70
Piede Stem finitura manganese / Stem foot in manganese finish





Gioco di trame e colori per progetti esclusivi.
/ Textures and colours games for unique projects.



Struttura cm 200 con due pacchetti schiena cm 90 e un pacchetto bracciolo alto, struttura cm 130 con pacchetto schiena cm 80 e pacchetto bracciolo alto
/ Structure cm 200 with two backrest packs cm 90 and one high armrest pack, structure cm 130 with backrest pack cm 80 and high armrest pack
Piede Spill finitura nero opaco / Spill foot in matte black finish
Cuscino poggiatesta e cuscini decoro cm 60x30 / Headrest cushion and decorative cushions cm 60x30
Tavolino Bridge cm 120x60 / Bridge coffee table cm 120x60



Struttura cm 200 con due pacchetti schiena cm 90 e un pacchetto bracciolo alto,
struttura Esa con due pacchetti schiena cm 70 e uno cm 80, struttura Penta sx
/ Structure cm 200 with two backrest packs cm 90 and one high armrest pack,
Esa structure with two backrest packs cm 70 and one cm 80, Penta structure lh.
Cuscini decoro cm 55x45 / Decorative cushions cm 55x45
Tavolino contenitore / Storage coffee table





Struttura cm 200 con due pacchetti
schiena cm 90 e struttura Penta sx
con pacchetto bracciolo alto.
Cuscino decoro cm 55x45
Tavolino contenitore

/ Structure cm 200 with two backrest
packs cm 90 and Penta structure lh
with high armrest pack
Decorative cushion cm 55x45
Storage coffee table

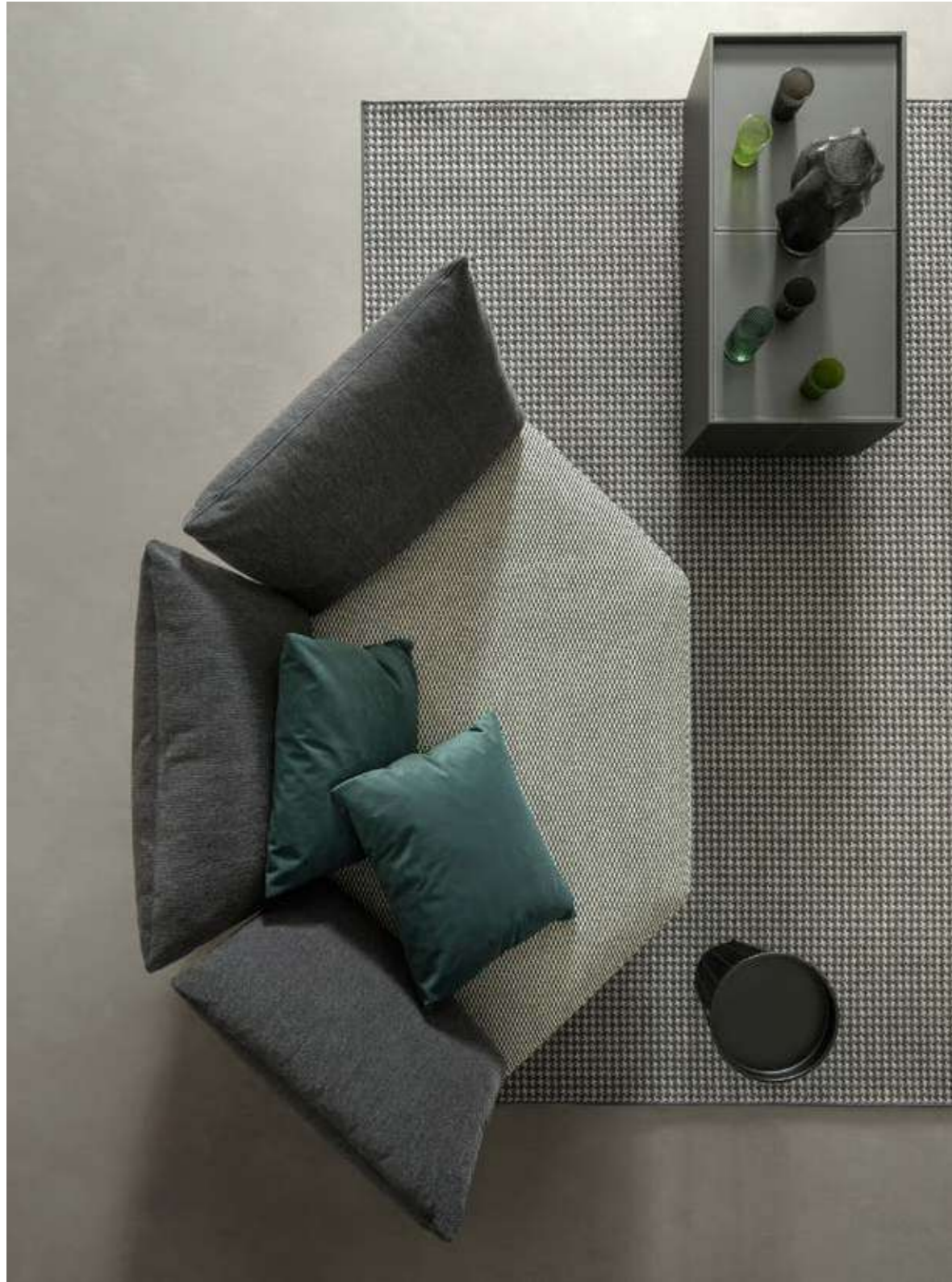

**Estrema flessibilità
compositiva.**

Struttura Esa con due
pacchetti schiena cm 70
e uno cm 80
Cuscini decoro cm 55x45
Tavolino contenitore
/ Extreme compositional
flexibility.
Esa structure with two
backrest packs cm 70
and one cm 80
Decorative cushions
cm 55x45
Storage coffee table







Piede Blank,
dettaglio inconfondibile
proposto in tre finiture:
manganese, anodic
bronze e nero opaco.
/ Blank foot,
a unique detail offered
in three finishes:
manganese, anodic
bronze and matte black.



Componibile panchetta reversibile cm 260 / Composable with reversible bench cm 260
Piede finitura nero opaco / Foot in matte black finish
Cuscini Soft cm 60x35 / Soft cushions cm 60x35
Tavolino Bridge cm 120x60 / Bridge coffee table cm 120x60





Componibile con pouff e panchetta
cm 260 sx / Composable with pouf
and bench cm 260 lh
Piede finitura nero opaco
/ Foot in matte black finish
Cuscini Soft cm 60x35
/ Soft cushions cm 60x35
Tavolino Bridge cm 120x60
/ Bridge coffee table cm 120x60



**Finiture e contrasti
di colori che
esaltano la forma.**
/ Finishes and colour
contrasts that
valorise the shape.



Divano laterale cm 182 sx con trapunta Band e pouff goccia dx con schiena Move con trapunta Band
/ Lateral sofa cm 182 lh with Band quilting and drop-shaped pouf rh with Move backrest with Band quilting
Piede finitura anodico bronzo / Foot in anodic bronze finish
Cuscini Soft cm 60x35 / Soft cushions cm 60x35
Tavolino contenitore / Storage coffee table





**Abbinamenti inconsueti
di forme e finiture per
valorizzare la zona living.**

/ Unusual shapes
and finishes pairing to
valorise the living zone.







**Scelta anticonformista:
un solo carattere,
tante possibilità.**

*/ A nonconformist choice:
just one character,
infinite possibilities.*

dafne.

Divano cm 230 / Sofa cm 230
Piede Odd finitura nero opaco / Odd foot in matte black finish
Cuscini Soft cm 60x35 / Soft cushions cm 60x35

66 / 67







**Configurazioni
estremamente
interessanti.**
/ Extremely
interesting
configurations.









Finiture distintive.
/ Distinctive finishes.

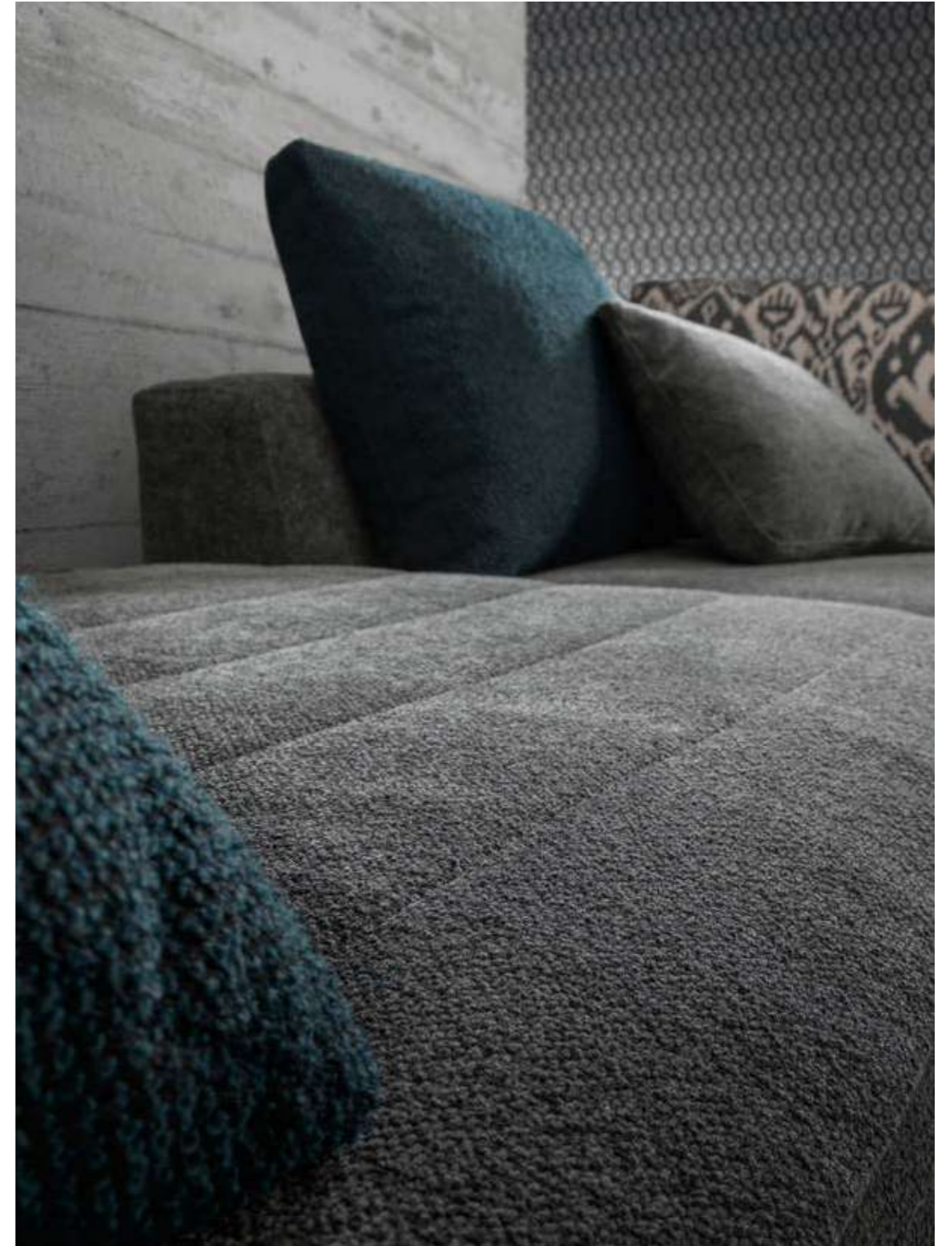

Penisola angolare cm 185 sx con trapunta Band, centrale con pouff cm 115 dx con trapunta Band e panchetta dx
/ Corner chaise longue cm 185 lh with Band quilting, central element with pouf cm 115 rh with Band quilting and bench rh
Piede Spill finitura nero opaco / Spill foot in matte black finish
Cuscini bracciolo cm 40x40 e 60x35 / Armrest cushions cm 40x40 and 60x35
Accessorio Cloak e tavolino contenitore / Cloak accessory and storage coffee table









Accessori integrati nella forma per soddisfare esigenze di praticità. Disponibili in tre finiture nera, beige e bianca.
/ Accessories integrated in the shape, in order to satisfy practicality needs. Available in three finishes: black, beige or white.

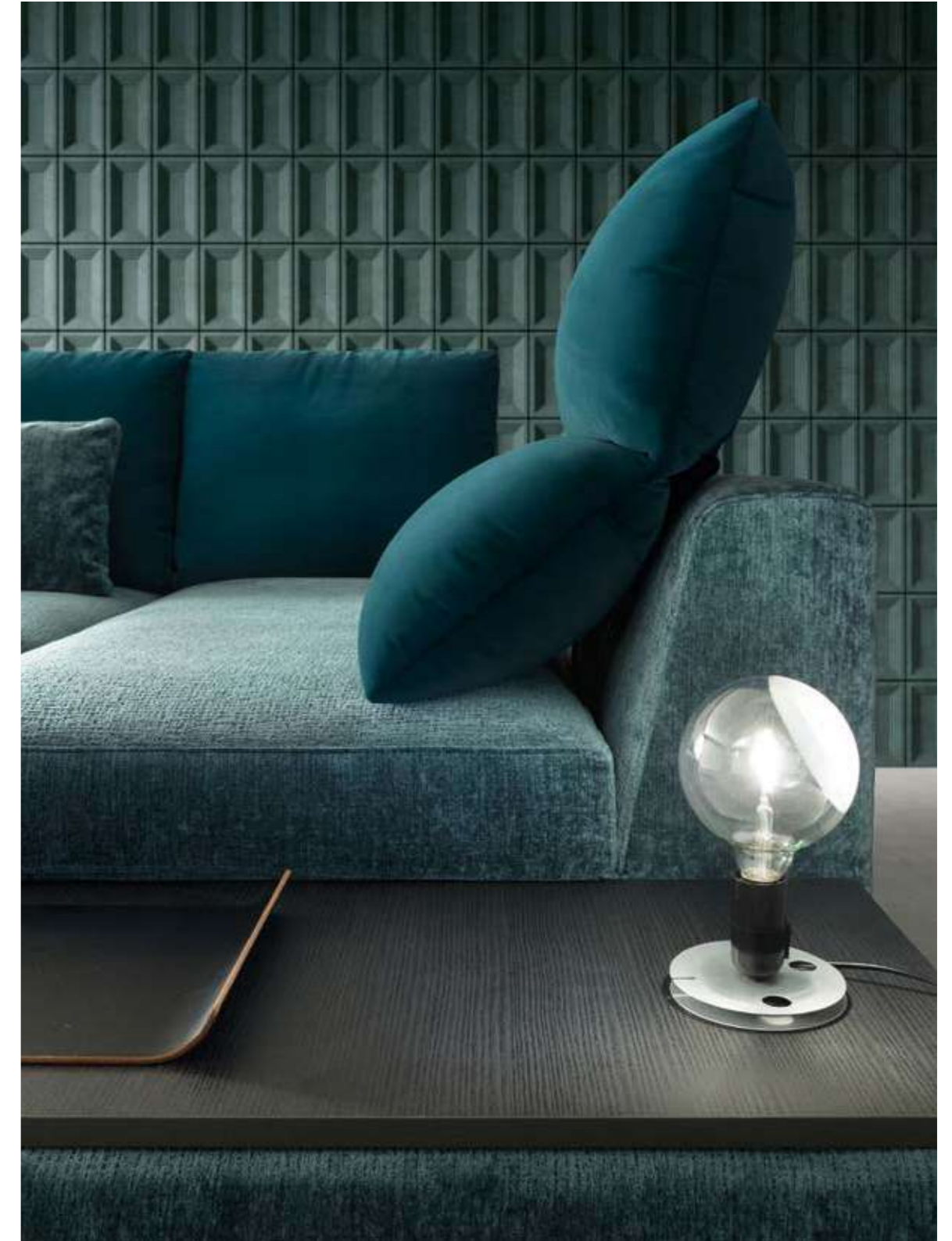







**Oltre la convenzione
di spazio predefinito.**
/ Beyond the standard
idea of space.





Variazione di profondità
della seduta e sistema
Feet per un comfort ai
massimi livelli.
/ Change of seating
depth and Feet system
for maximum levels of
of comfort.



madison.

Divano laterale cm 191 sx con un sistema Feet e panchetta maxi dx / Lateral sofa cm 191 lh with Feet system and maxi bench rh
Piedi finitura anodic bronze / Feet in anodic bronze finish
Cuscini bracciolo cm 60x35 e poggiatesta cm 85 / Armrest cushions cm 60x35 and headrest cm 85
Tavolino Bridge cm 120x60 / Bridge coffee table cm 120x60

98 / 99





**Connubio perfetto
tra design e relax.**

Sistema Feet con
regolazione elettrica
azionato tramite
telecomando.

/ Perfect combination
between design and
relax.

Feet system with
automatic regulation,
operated by
remote control.



Divano laterale cm 191 dx, angolo Penta sx e poltrona laterale cm 106 sx / Lateral sofa cm 191 rh,
Penta corner lh and lateral armchair cm 106 lh
Piede finitura nero opaco / Foot in matte black finish
Cuscini decoro cm 55x45 / Decorative cushions cm 55x45
Tavolino Level diametro cm 78 / Level coffee table cm 78





Divano laterale cm 191 dx,
angolo Penta sx e pouff cm 90x65
/ Lateral sofa cm 191 rh,
Penta corner lh and pouf cm 90x65
Cuscini decoro 55x45
/ Decorative cushions cm 55x45
Tavolino Level diametro cm 78
/ Level coffee table diameter cm 78



Divano laterale cm 200 dx e angolo penisola con accessorio Jolie cm 227 sx
/ Lateral sofa cm 200 rh and corner chaise longue with Jolie accessory cm 227 lh
Piede Spill finitura manganese / Spill foot in manganese finish
Tavolino Bridge cm 120x60 / Bridge coffee table cm 120x60





**Versatilità sorprendente
per vivere il quotidiano
senza schemi e convenzioni.**
/ Surprising versatility to enjoy
the everyday life without
any scheme or principle.











**Leggerezza strutturale
e lavorazioni di pregio.**
/ Structural lightness and
valuable works.







**Pouff ad angolo
per una composizione
di carattere.**

/ Corner pouf for
a composition with
personality.









Elegante senza rinunciare al comfort.
/ Elegant, without giving up on the comfort.

Divano laterale cm 195 sx e penisola angolare con pouff dx
/ Lateral sofa cm 195 lh and corner chaise longue with pouf rh
Piede Peak finitura cromo
/ Peak foot in chrome finish
Cuscini decoro cm 55x45 e cm 40x40
/ Decorative cushions cm 55x45 and cm 40x40



ares.

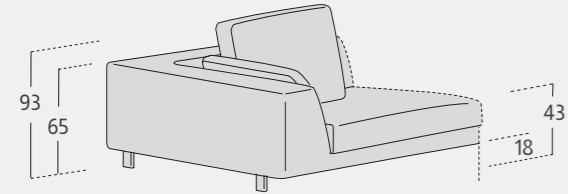

POSSIBILITÀ / POSSIBILITY



Trapunta Band su cuscino seduta / Band quilting on seating cushion

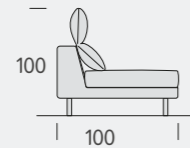

Schiena Comfort / Comfort backrest



Per posizionare la schiena Comfort inserire la parte in metallo tra seduta e scocca. To place the Comfort backrest insert the metal part in between the structure and the seating.

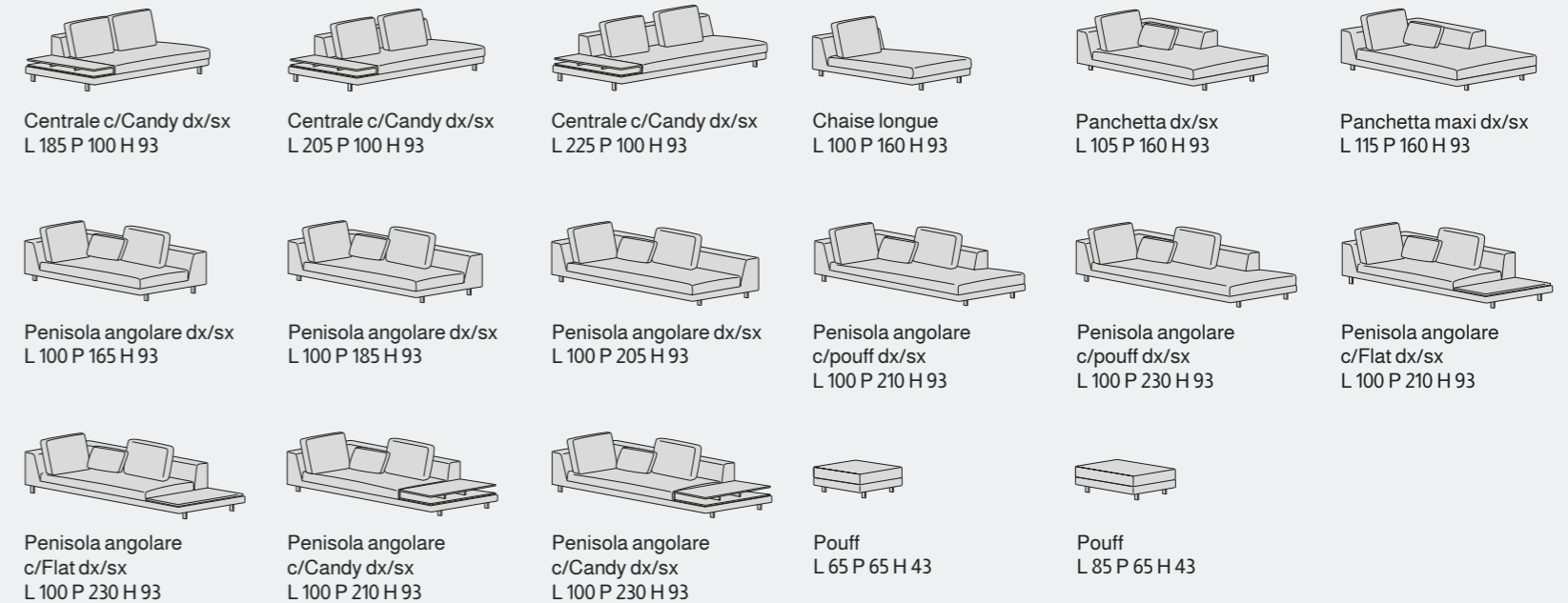
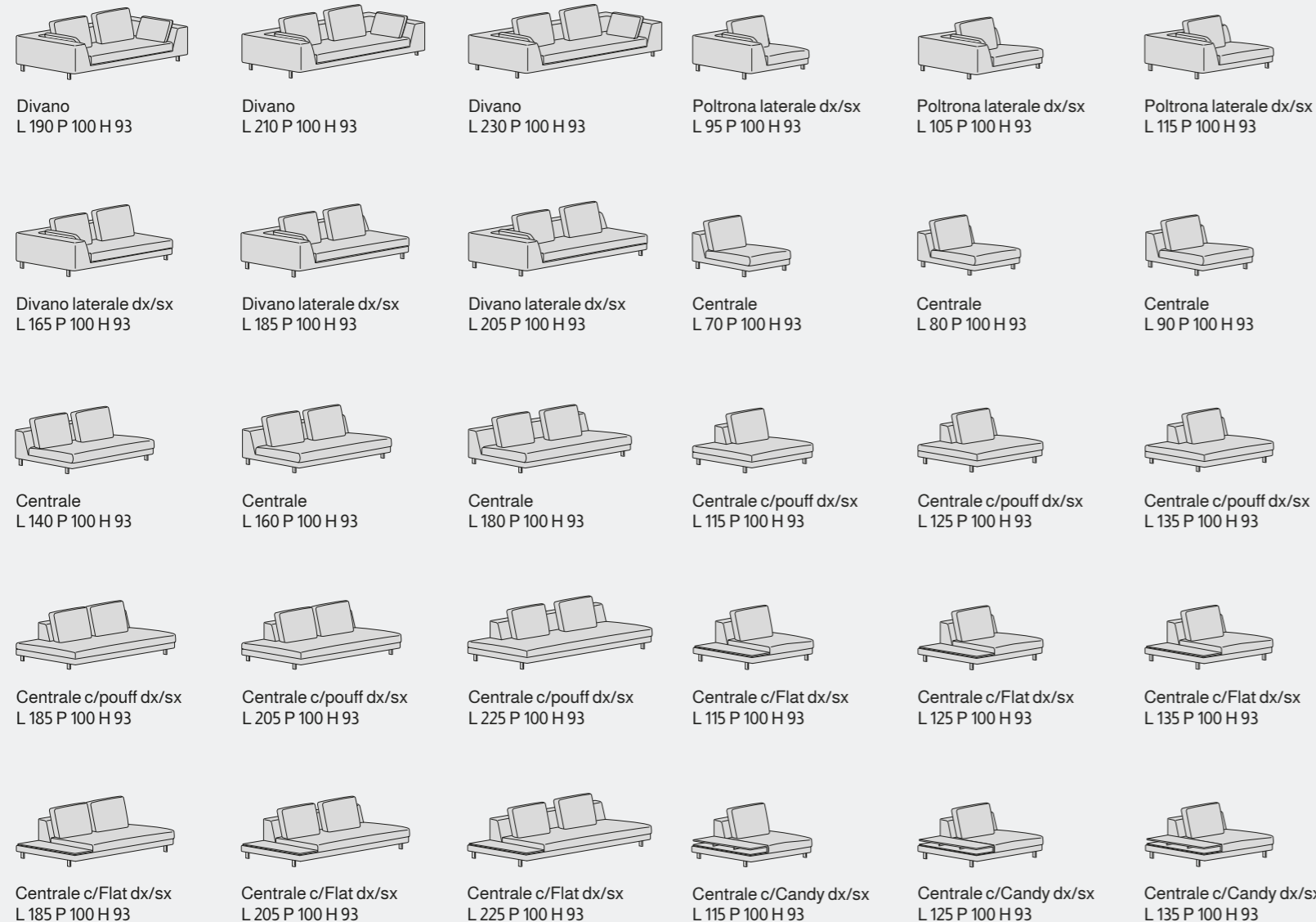

TIPOLOGIA PIEDI / FEET TYPE



Piede Tag in metallo finitura manganese di serie, anodic bronze o nero opaco optional Standard manganese finish metal Tag foot, anodic bronze or matte black finish optional



Piede Nip in metallo finitura cromo o manganese optional Optional chrome or manganese finish metal Nip foot



Piede Spill in metallo finitura anodic bronze, manganese o nero opaco optional Optional anodic bronze, manganese or matte black finish metal Spill foot



Piede Stive in metallo finitura anodic bronze, manganese o nero opaco optional Optional anodic bronze, manganese or matte black finish metal Stive foot

FINITURE ACCESSORI FLAT E CANDY / FLAT AND CANDY ACCESSORIES' FINISHES

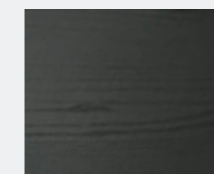

Finitura nera di serie Standars black finish

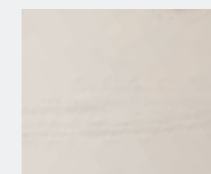

Finitura beige optional Optional beige finish

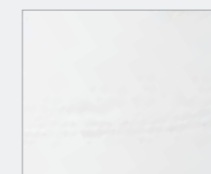

Finitura bianca optional Optional white finish

INFORMAZIONI TECNICHE / TECHNICAL INFORMATION

Struttura: legno stagionato e agglomerato con imbottitura in poliuretano espanso indeformabile D40, completamente rivestito in ovatta di poliestere gr 300.

Molleggio seduta: nastri elastici in fibra polipropilenica e lattice da mm 80, tesi meccanicamente.

Cuscini seduta: in poliuretano espanso indeformabile D32, rivestiti in ovatta di poliestere gr 400.

Cuscini schienale: in piuma d'oca sterilizzata e fibra di poliestere suddivisi in comparti.

Schiena Comfort: in piuma d'oca sterilizzata e fibra di poliestere suddivise in comparti con supporto in metallo nero opaco.

Rivestimenti: completamente sfoderabile in tessuto, parzialmente sfoderabile in ecopelle. Non prevista la versione in pelle.

Structure: seasoned and bonded wood with padding in D 40 non-deformable polyurethane foam, fully wrapped in 300 gr. polyester batting.

Seat springing: elastic bands in polypropylene fiber and 80 mm latex, mechanically stretched.

Seat cushions: in D 32 non-deformable polyurethane foam, wrapped in 400 gr. polyester batting.

Back cushions: in sterilized goose down and polyester fiber, divided into compartments.

Comfort backrests: in sterilized goose down and polyester fiber, divided into compartments with matte black metal support.

Upholstery: fully removable in fabric, partially removable in eco-leather. Leather version is not available.

blank.minimal

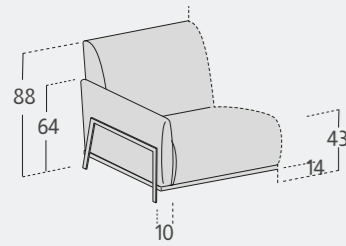

blank.open

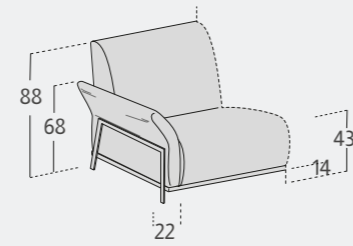

POSSIBILITÀ / POSSIBILITY

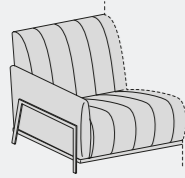

Trapunta Band su cuscini seduta e schienale
/ Band quilting on seating and backrest cushions

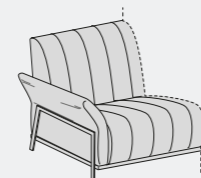

Trapunta Band su cuscini seduta e schienale
/ Band quilting on seating and backrest cushions

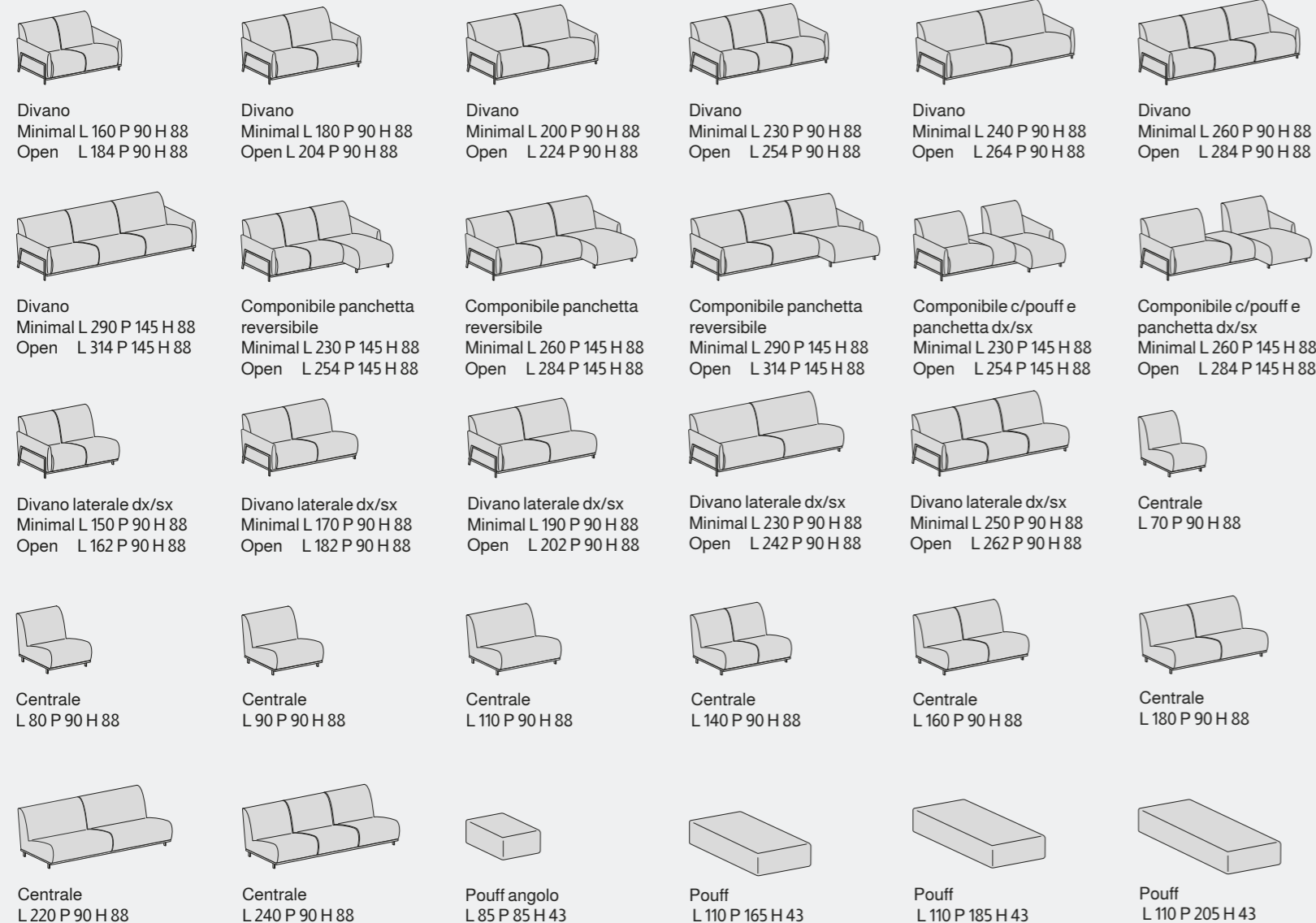

PACCHETTI SCHIENA / BACKREST PACKS

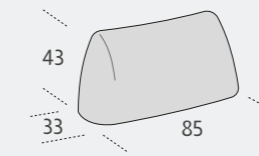

Schiena Move (disponibile anche con trapunta Band)
/ Move backrest (available also with Band quilting)

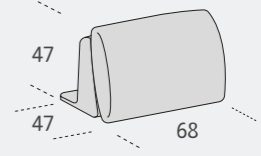

Pacchetto schiena Matrix
/ Matrix backrest pack

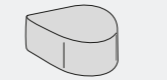

Pouff goccia dx/sx
L 140 P 140 H 43

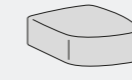

Pouff inclinato dx/sx
L 125 P 125 H 43

TIPOLOGIA PIEDE/ FOOT TYPE



Piede Blank in metallo finitura manganese di serie, anodic bronze o nero opaco optional
Standard manganese finish metal Blank foot, anodic bronze or matte black finish optional

FINITURE PIEDE/ FOOT FINISHES

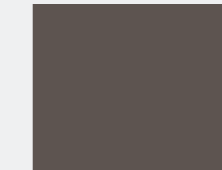

Finitura manganese di serie
Standard manganese finish

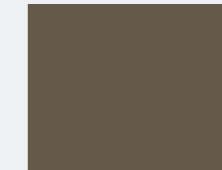

Finitura anodic bronze optional
Optional anodic bronze finish

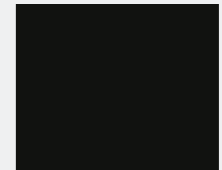

Finitura nero opaco optional
Optional matte black finish

INFORMAZIONI TECNICHE / TECHNICAL INFORMATION

Base: pannello in multistrato di legno con imbottitura in poliuretano espanso indeformabile e vellutino accoppiato.

Base: multilayer wood panel with padding in non-deformable polyurethane foam with velveteen coupled.

Struttura: legno stagionato e agglomerato con imbottitura in poliuretano espanso indeformabile.

Frame: seasoned and bonded wood with padding in non-deformable polyurethane foam.

Molleggio seduta: nastri elastici in fibra polipropilenica e lattice da mm 80, tesi meccanicamente.

Seat springing: elastic bands in polypropylene fiber and 80 mm latex, mechanically stretched.

Cuscini seduta e schienale: integrate nella struttura in poliuretano espanso indeformabile a quote differenziate D35/30 rivestite in ovatta di poliestere gr 300.

Seat and back cushion: included in the structure, in non-deformable polyurethane foam at different heights D 35/30, covered in 300 gr. polyester batting.

Bracciolo: in poliuretano espanso indeformabile rivestito in vellutino accoppiato gr 400 con inserto in legno e agglomerato.

Armrest: in non-deformable polyurethane foam covered in 400 gr. velveteen coupled, with wooden and bonded insert.

Schiena Move: base in multistrato con inserto in metallo e poliuretano espanso indeformabile super soft D25 rivestito in vellutino accoppiato gr 300.

Move backrest: base in multilayer with metal insert and D 25 super soft non-deformable polyurethane foam, covered in 300 gr. velveteen coupled.

Pacchetto schiena Matrix: composto da reggischiena in multistrato e nastri elastici in fibra polipropilenica e lattice da 60 mm rivestito in vellutino accoppiato gr 300, e cuscino integrato in piuma d'oca sterilizzata e fibra di poliestere suddiviso in comparti.

Matrix backrest pack: composed of backrest support in multilayer and elastic bands in polypropylene fiber and 60 mm latex, covered in 300 gr. velveteen coupled, and included cushion in sterilized goose down and polyester fiber, divided into compartments.

Rivestimenti: completamente sfoderabile in tessuto, non sfoderabile in ecopelle. Non prevista la versione in pelle. Tessuto o ecopelle accoppiato a materiale tecnico in fibra di poliestere.

Upholstery: fully removable in fabric, partially removable in eco-leather. Leather version is not available. Fabric or eco-leather are coupled with a technical material in polyester fiber.



I centrali si possono montare a piacere attraverso i perni posti sotto la seduta e i fori predisposti sul pianale.
Central elements can be assembled as desired through the pins placed underneath the seating and the holes prepped on the platform.

dafne.

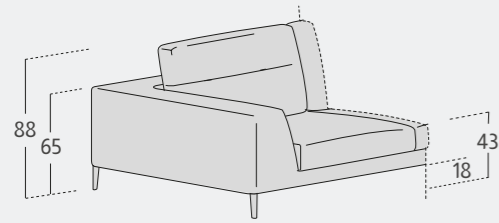

POSSIBILITÀ / POSSIBILITY

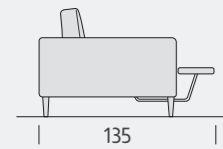
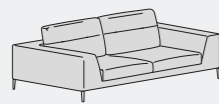
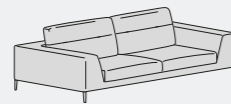
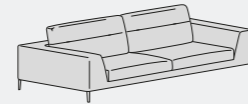
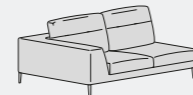
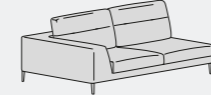
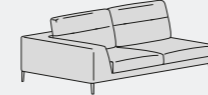
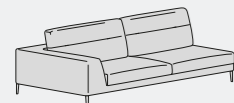
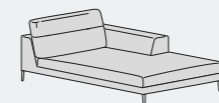
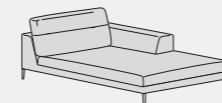
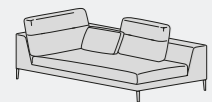
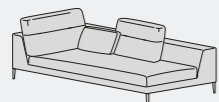
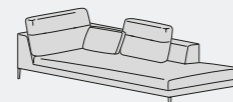
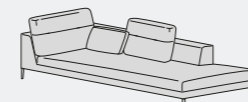
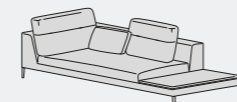
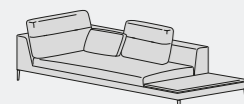
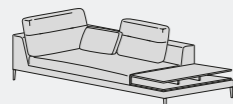
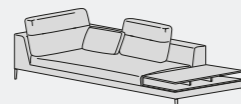
Sistema Feet
/ Feet systemDivano
L 170 P 100 H 88
- Sistema FeetDivano
L 190 P 100 H 88
- Sistema FeetDivano
L 210 P 100 H 88
- Sistema FeetDivano
L 230 P 100 H 88
- Sistema FeetPoltrona laterale dx/sx
L 95 P 100 H 88
- Sistema FeetPoltrona laterale dx/sx
L 105 P 100 H 88
- Sistema FeetPoltrona laterale dx/sx
L 115 P 100 H 88
- Sistema FeetDivano laterale dx/sx
L 145 P 100 H 88
- Sistema FeetDivano laterale dx/sx
L 165 P 100 H 88
- Sistema FeetDivano laterale dx/sx
L 185 P 100 H 88
- Sistema FeetDivano laterale dx/sx
L 205 P 100 H 88
- Sistema FeetCentrale
L 70 P 100 H 88
- Sistema FeetCentrale
L 80 P 100 H 88
- Sistema FeetCentrale
L 90 P 100 H 88
- Sistema FeetPanchetta dx/sx
L 105 P 160 H 88Panchetta maxi dx/sx
L 115 P 160 H 88Penisola angolare dx/sx
L 100 P 165 H 88Penisola angolare dx/sx
L 100 P 185 H 88Penisola angolare dx/sx
L 100 P 205 H 88Penisola angolare
c/pouff dx/sx
L 100 P 210 H 88Penisola angolare
c/pouff dx/sx
L 100 P 230 H 88Penisola angolare
c/Flat dx/sx
L 100 P 210 H 88Penisola angolare
c/Flat dx/sx
L 100 P 230 H 88Penisola angolare
c/Candy dx/sx
L 100 P 210 H 88Penisola angolare
c/Candy dx/sx
L 100 P 230 H 88Pouff
L 65 P 65 H 43Pouff
L 85 P 65 H 43

TIPOLOGIA PIEDI / FEET TYPE

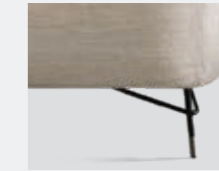
**Piede Link** in metallo
finitura nichel nero
di serie, finitura cromo
optional
Standard black nickel
finish metal Link foot,
chrome finish optional**Piede Log** in legno
colore naturale, noce o
wengè optional
Optional natural,
walnut or wengè colour
wooden Log foot**Piede Odd** in metallo
finitura anodic bronze,
manganese o nero opaco
optional
Optional anodic bronze,
manganese or matte
black finish metal Odd
foot**Piede Spill** in metallo
finitura anodic bronze,
manganese o nero opaco
optional
Optional anodic bronze,
manganese or matte
black finish metal Spill
foot**Piede Yin** in metallo
finitura nichel nero/grigio
optional
Optional nickel black/grey
finish metal Yin foot

FINITURE ACCESSORI FLAT E CANDY / FLAT AND CANDY ACCESSORIES' FINISHES

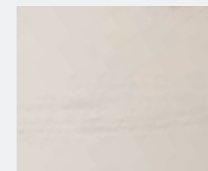
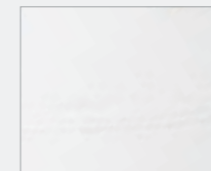
Finitura nera di serie
Standard black finishFinitura beige optional
Optional beige finishFinitura bianca optional
Optional white finish

INFORMAZIONI TECNICHE / TECHNICAL INFORMATION

Struttura: legno stagionato e agglomerato con imbottitura in poliuretano espanso indeformabile D40, completamente rivestito in ovatta di poliestere gr 300.

Molleggio seduta: nastri elastici in fibra polipropilenica e lattice da mm 80, tesi meccanicamente.

Cuscini seduta: in poliuretano espanso indeformabile D32, rivestiti in ovatta di poliestere gr 400.

Cuscini schienale: in piuma d'oca sterilizzata e fibra di poliestere suddivisi in comparti.

Rivestimenti: completamente sfoderabile in tessuto, parzialmente sfoderabile in ecopelle. Non prevista la versione in pelle. Tessuto o ecopelle accoppiato a materiale tecnico in fibra di poliestere nella cuscineria.

Sistema Feet: meccanismo elettrico in metallo, completamente sfoderabile in tessuto, non sfoderabile in ecopelle.

Structure: seasoned and bonded wood with padding in D 40 non-deformable polyurethane foam, fully wrapped in 300 gr. polyester batting.

Seat springing: elastic bands in polypropylene fiber and 80 mm latex, mechanically stretched.

Seat cushions: in D 32 non-deformable polyurethane foam, covered in 400 gr. polyester batting.

Back cushions: in sterilized goose down and polyester fiber, divided into compartments.

Upholstery: fully removable in fabric, partially removable in eco-leather. Leather version is not available.

Fabric and eco-leather are coupled with a technical material in polyester fiber in the cushions.

Feet system: electric mechanism in metal, upholstery is fully removable in fabric, not removable in eco-leather.

ginny.

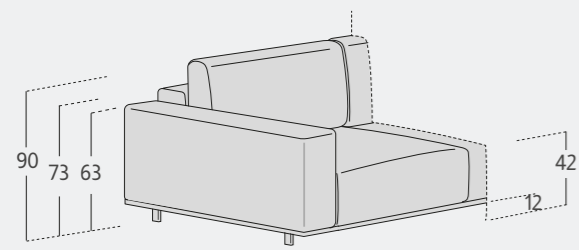

POSSIBILITÀ / POSSIBILITY

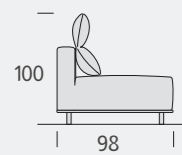
Schiena Comfort
/ Comfort backrest

Per posizionare la schiena Comfort inserire la parte in metallo tra seduta e scocca.
To place the Comfort backrest insert the metal part in between the structure and the seating.

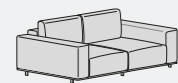
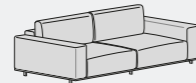
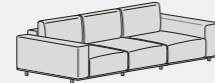
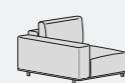
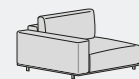
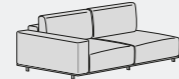
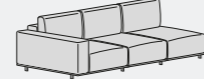
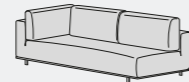
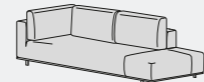
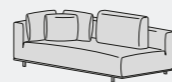
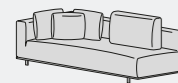
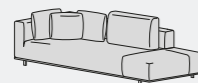
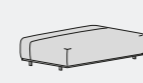
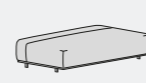
Divano
L 180 P 98 H 90Divano
L 200 P 98 H 90Divano
L 220 P 98 H 90Divano
L 250 P 98 H 90Poltrona laterale dx/sx
L 90 P 98 H 90Poltrona laterale dx/sx
L 100 P 98 H 90Poltrona laterale dx/sx
L 110 P 98 H 90Divano laterale dx/sx
L 160 P 98 H 90Divano laterale dx/sx
L 180 P 98 H 90Divano laterale dx/sx
L 200 P 98 H 90Divano laterale dx/sx
L 230 P 98 H 90Centrale
L 70 P 98 H 90Centrale
L 80 P 98 H 90Centrale
L 90 P 98 H 90Centrale
L 140 P 98 H 90Centrale
L 160 P 98 H 90Centrale
L 180 P 98 H 90Panchetta dx/sx
L 100 P 158 H 90Panchetta maxi dx/sx
L 110 P 158 H 90Angolo retto dx/sx
L 98 P 123 H 90Angolo penisola dx/sx
L 98 P 173 H 90
(disponibile con
1 schiena Comfort)Angolo penisola dx/sx
L 98 P 193 H 90
(disponibile con
1 schiena Comfort)Angolo penisola
c/pouff dx/sx
L 98 P 223 H 90
(disponibile con
1 schiena Comfort)Penisola angolare
c/3 cuscini dx/sx
L 98 P 173 H 90Penisola angolare
c/3 cuscini dx/sx
L 98 P 193 H 90Penisola angolare
c/pouff e 3 cuscini dx/sx
L 98 P 223 H 90Pouff
L 50 P 98 H 42Pouff
L 98 P 98 H 42Pouff
L 158 P 98 H 42Pouff
L 178 P 98 H 42Pouff
L 198 P 98 H 42Pouff mono
L 70 P 60 H 42Pouff mono
L 80 P 60 H 42Pouff mono
L 90 P 60 H 42

PACCHETTI SCHIENA / BACKREST PACKS

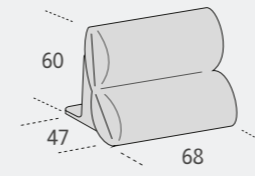
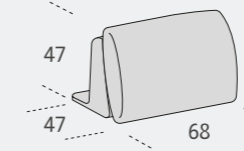
Pacchetto schiena Relax
/ Relax backrest packPacchetto schiena Matrix
/ Matrix backrest pack

TIPOLOGIA PIEDE / FOOT TYPE



Piede Tag in metallo
finitura manganese di serie,
anodic bronze o nero opaco
optional
Standard manganese finish
metal Tag foot, anodic bronze
or matte black optional

INFORMAZIONI TECNICHE / TECHNICAL INFORMATION

Struttura: legno stagionato e agglomerato con imbottitura in poliuretano espanso indeformabile.

Molleggio seduta: nastri elastici in fibra polipropilenica e lattice da mm 80, tesi meccanicamente.

Cuscini seduta: integrati nella struttura in poliuretano espanso indeformabile a quote differenziate D35/30 rivestite in ovatta di poliestere gr 300.

Cuscini schienale: in piuma d'oca sterilizzata e fibra di poliestere suddivisi in compartimenti.

Schiena Comfort: in piuma d'oca sterilizzata e fibra di poliestere suddivise in compartimenti con supporto in metallo nero opaco.

Pacchetto schiena Relax e Pacchetto schiena Matrix: composti da reggischienale in multistrato e nastri elastici in fibra polipropilenica e lattice da 60 mm rivestito in vellutino accoppiato gr 300, e cuscino integrato in piuma d'oca sterilizzata e fibra di poliestere suddiviso in compartimenti.

Rivestimenti: completamente sfoderabile in tessuto, parzialmente in ecopelle. Non prevista la versione in pelle.
Tessuto o ecopelle accoppiato a materiale tecnico in fibra di poliestere.

Structure: seasoned and bonded wood with non-deformable polyurethane foam.

Seat springing: elastic bands in polypropylene fiber and 80 mm latex, mechanically stretched.

Seat cushions: included in the structure, in non-deformable polyurethane foam at different heights D 35/30, covered in 300 gr. polyester batting.

Back cushions: in sterilized goose down and polyester fiber, divided into compartments.

Comfort backrest: in sterilized goose down and polyester fiber, divided into compartments with matte black metal support.

Relax backrest pack and Matrix backrest pack: composed of backrest support in multilayer and elastic bands in polypropylene fiber and 60 mm latex, covered in 300 gr. velveteen coupled, and included cushion in sterilized goose down and polyester fiber, divided into compartments.

Upholstery: fully removable in fabric, partially removable in eco-leather. Leather version is not available.

Fabric or eco-leather are coupled with a technical material in polyester fiber.

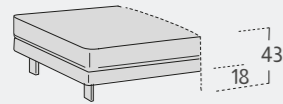

POSSIBILITÀ / POSSIBILITY



Pacchetto schiena spostabile / Movable backrest pack
L 60/70/80/90/100/110/130 P 28 (20+8)

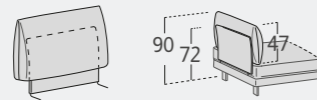

Pacchetto bracciolo alto spostabile / High movable armrest pack
L 80 P 28 (20+8)

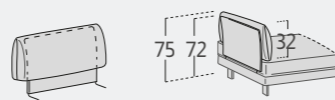

Pacchetto bracciolo basso spostabile / Low movable armrest pack
L 70 P 28 (20+8)

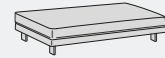

Struttura L 160 P 80 H 43

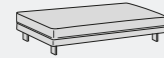

Struttura L 180 P 80 H 43

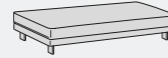

Struttura L 200 P 80 H 43



Struttura L 220 P 80 H 43



Struttura per panchetta L 160 P 100 H 43



Struttura L 130 P 130 H 43



Struttura Penta dx/sx L 108 P 115 H 43

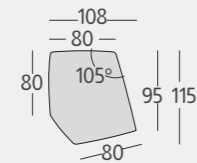

Struttura Esa L 190 P 115 H 43

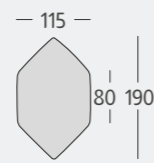

Cuscino poggiatesta L 60 x 25

Esempio per lo sviluppo del divano con schienali chiuse con struttura da L 160 P 80 H 43 / Example for sofa configuration with closed backrests and structure W.160 D.80 H.43

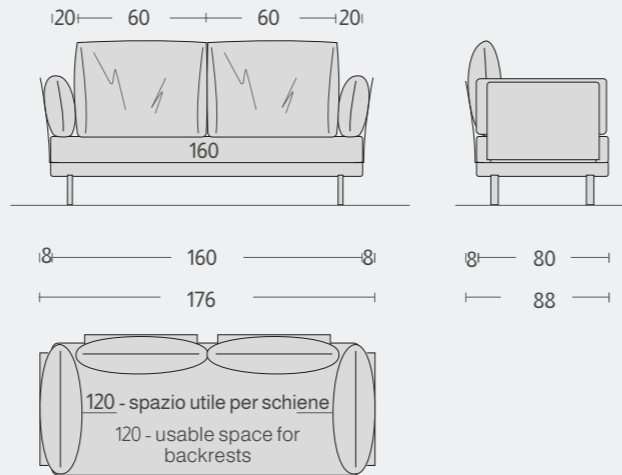
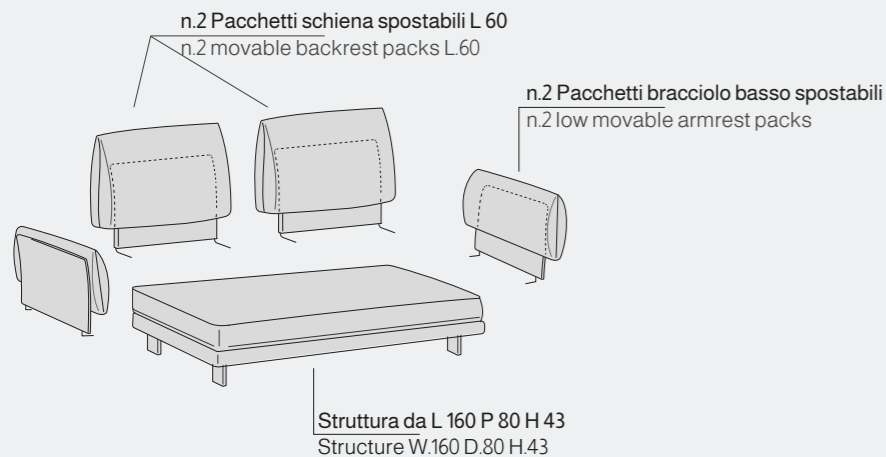

Nel calcolo dell' opzione divano, con schienali chiuse, considerare l'ingombro interno (cm 20) del pacchetto bracciolo (alto o basso) / In the calculation for sofa's options, with closed backrest, consider the internal dimensions (cm 20) of the armrest pack (high or low)

PANCHETTA SX
con struttura per panchetta da L 160 P 100 H 43
- n.1 pacchetto schiena da L 80 cm
- n.1 pacchetto bracciolo alto/basso / BENCH LH
with structure for bench W.160 D.100 H.43
-n.1 backrest pack W. cm 80
-n.1 high/low armrest pack

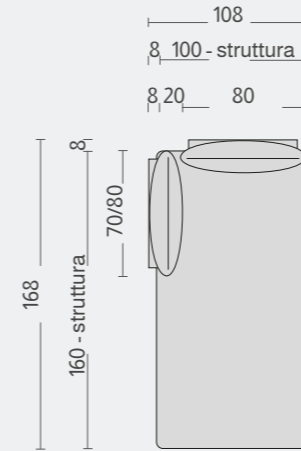

STRUTTURA PENTA DX
per composizione con schienali chiuse utilizzare:
- n.2 schienali da L 80 cm / PENTA STRUCTURE RH
for composition with closed backrest use:
-n.2 backrests W.80

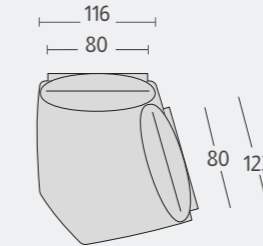

STRUTTURA ESA
per composizione con schienali chiuse utilizzare:
- n. 1 schiena da L 80 cm
- n.2 schienali da L 70 cm / ESA STRUCTURE
for composition with closed backrests use:
-n.1 backrest W.80
-n.2 backrests W.70

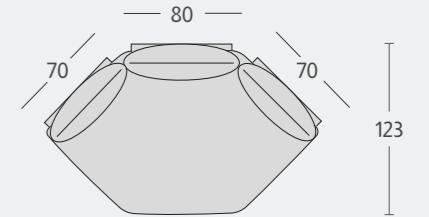

TIPOLOGIA PIEDI / FEET TYPE



Piede Tag in metallo finitura manganese di serie, anodic bronze o nero opaco optional
Standard manganese finish metal Tag foot, anodic bronze or matte black optional



Piede Log in legno colore naturale, noce o wengè optional
Optional natural, walnut or wengè colour wooden Log foot



Piede Spill in metallo finitura anodic bronze, manganese o nero opaco optional
Optional anodic bronze, manganese or matte black finish metal Spill foot



Piede Stem in metallo finitura manganese optional
Optional manganese finish metal Stem foot

INFORMAZIONI TECNICHE / TECHNICAL INFORMATION

Struttura: legno stagionato e multistrato completamente rivestito in fibra di poliestere.

Cuscino seduta: in poliuretano espanso indeformabile D32 rivestito in ovatta di poliestere gr 300.

Reggischienale: struttura in metallo, molleggio in nastri elastici in fibra polipropilenica e lattice da mm 30, imbottitura in poliuretano espanso indeformabile, rivestito in fibra di poliestere.

Cuscino schienale/bracciolo: in piuma d' oca sterilizzata e fibra di poliestere suddiviso in comparti.

Rivestimenti: completamente sfoderabile in tessuto, parzialmente sfoderabile in pelle ed ecopelle. Nella versione con il rivestimento in pelle ci potranno essere delle cuciture aggiuntive.

Structure: multilayer seasoned wood, fully covered in polyester fiber.

Seat cushion: in D 32 non-deformable polyurethane foam, covered in 300 gr. polyester batting.

Backrest support: frame in metal, springing in elastic bands in polypropylene fiber and 30 mm latex, padding in non-deformable polyurethane foam, covered in polyester fiber.

Back cushions /armrest: in sterilized goose down and polyester fiber, divided into compartments.

Upholstery: fully removable in fabric, partially removable in leather or in eco-leather. In the leather version there could be additional sewings.



Strutture predisposte per posizionare con facilità i pacchetti schienale / bracciolo lungo il perimetro. Structures prepared to easily place backrest/armrest packs along the perimeter.

jack.tidy

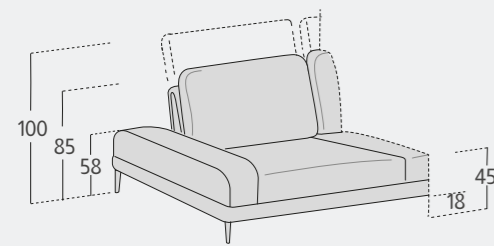

POSSIBILITÀ / POSSIBILITY

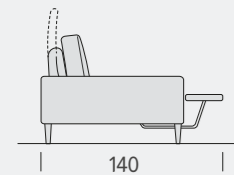

Sistema Feet
/ Feet system



Poltrona
L 115 P 105 H 85/100
- Sistema Feet

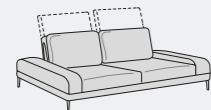

Divano
L 180 P 105 H 85/100
- Sistema Feet

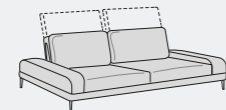

Divano
L 200 P 105 H 85/100
- Sistema Feet

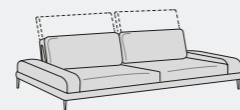

Divano
L 220 P 105 H 85/100
- Sistema Feet

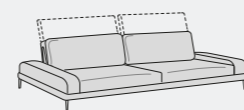

Divano
L 240 P 105 H 85/100
- Sistema Feet



Poltrona lat dx/sx
L 100 P 105 H 85/100
- Sistema Feet

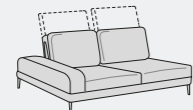

Divano lat dx/sx
L 155 P 105 H 85/100
- Sistema Feet

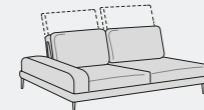

Divano lat dx/sx
L 175 P 105 H 85/100
- Sistema Feet

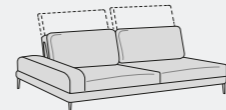

Divano lat dx/sx
L 195 P 105 H 85/100
- Sistema Feet

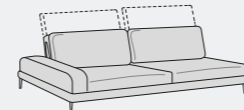

Divano lat dx/sx
L 215 P 105 H 85/100
- Sistema Feet

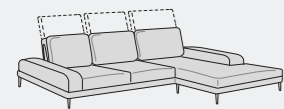

Componibile
c/panchetta dx/sx
L 245 P 162 H 85/100

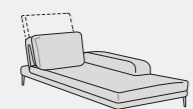

Panchetta dx/sx
L 100 P 162 H 85/100

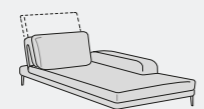

Panchetta maxi dx/sx
L 110 P 162 H 85/100

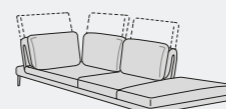

Penisola angolare
c/pouff dx/sx
L 105 P 225 H 85/100

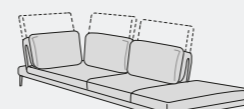

Penisola angolare
c/pouff dx/sx
L 105 P 235 H 85/100

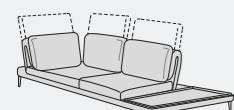

Penisola angolare
c/Even dx/sx
L 105 P 225 H 85/100

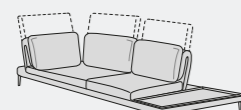

Penisola angolare
c/Even dx/sx
L 105 P 235 H 85/100

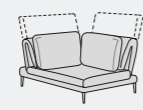

Angolo retto
L 105 P 105 H 85/100



Pouff
L 80 P 60 H 45

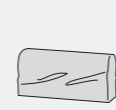

Cover per schiene Relax

jack.top

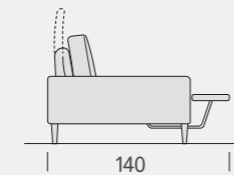
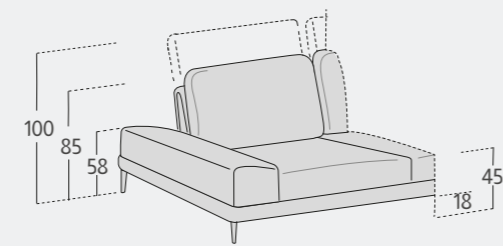

Sistema Feet
/ Feet system

TIPOLOGIA PIEDI / FEET TYPE

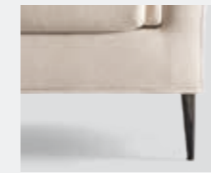

Piede Link in metallo
finitura nichel nero di
serie, finitura cromo
optional
Standard black nickel
finish metal Link foot,
chrome finish optional



Piede Hop in metallo
finitura manganese
optional
Optional manganese
finish metal Hop foot



Piede Log in legno
colore naturale, noce o
wengè optional
Optional natural, walnut
or wengè colour wooden
Log foot



Piede Spill in metallo
finitura anodic bronze,
manganese o nero opaco
optional
Optional anodic bronze,
manganese or matte
black finish metal Spill
foot



Piede Stem in metallo
finitura manganese
optional
Optional manganese
finish metal Stem foot

FINITURE ACCESSORIO EVEN / EVEN ACCESSORY FINISHES



Finitura nera di serie
Standars Black finish

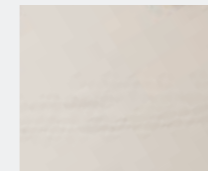

Finitura beige optional
Optional beige finish

INFORMAZIONI TECNICHE / TECHNICAL INFORMATION

Struttura: legno stagionato e agglomerato completamente rivestita in vellutino accoppiato.

Struttura schiena: in metallo con nastri elastici in fibra polipropilenica e lattice da mm 60, rivestita in poliuretano espanso indeformabile D40 e vellutino accoppiato a fibra di poliestere gr 300.

Cuscini seduta: in poliuretano espanso indeformabile D35 rivestito in ovatta di poliestere termolegata gr 500.

Cuscini schienale: in piuma d'oca sterilizzata e fibra di poliestere suddivisi in comparti.

Bracciolo: in poliuretano espanso indeformabile D35 rivestito in vellutino accoppiato e fibra di poliestere gr 300.

Rivestimenti: completamente sfoderabile in tessuto, parzialmente sfoderabile in pelle ed ecopelle. Nella versione con rivestimento in pelle ci potranno essere delle cuciture aggiuntive.

Sistema Feet: meccanismo elettrico in metallo, completamente sfoderabile in tessuto, non sfoderabile in pelle ed ecopelle.

Structure: seasoned and bonded wood, fully covered in velveteen coupled.

Backrest's frame: in metal with elastic bands in polypropylene fiber and 60 mm latex, covered in D 40 non-deformable polyurethane foam and velveteen coupled with 300 gr. polyester fiber.

Seat cushions: in D 35 non-deformable polyurethane foam, covered in 500 gr. heat-bonded polyester batting.

Back cushions: in sterilized goose down and polyester fiber, divided into compartments.

Armrest: in D 35 non-deformable polyurethane foam, covered in velveteen coupled and 300 gr. polyester fiber.

Upholstery: fully removable in fabric, partially removable in leather or in eco-leather. In the leather version there could be additional sewings.

Feet system: electric mechanism in metal, upholstery is fully removable in fabric, not removable in leather or in eco-leather.

living.bright

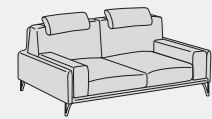
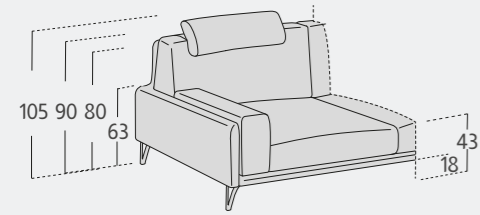

Divano
L 183 P 98 H 105



Divano
L 203 P 98 H 105



Divano
L 223 P 98 H 105

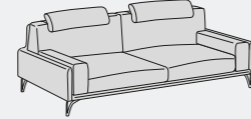

Divano
L 243 P 98 H 105

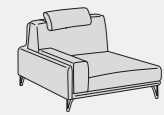

Poltrona laterale dx/sx
L 105 P 98 H 105



Divano laterale dx/sx
L 155 P 98 H 105

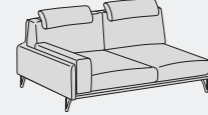

Divano laterale dx/sx
L 175 P 98 H 105

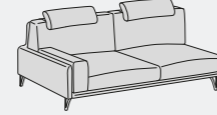

Divano laterale dx/sx
L 195 P 98 H 105

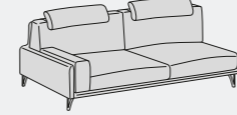

Divano laterale dx/sx
L 215 P 98 H 105

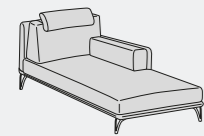

Panchetta dx/sx
L 113 P 163 H 105



Panchetta maxi dx/sx
L 123 P 163 H 105

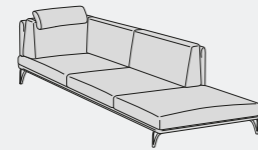

Penisola angolare
c/pouff dx/sx
L 98 P 235 H 105



Angolo retto
L 98 P 98 H 90



Pouff
L 75 P 65 H 43



Pouff
L 95 P 95 H 43



Pouff monoscocca
L 75 P 65 H 43



Pouff monoscocca
L 95 P 95 H 43

TIPOLOGIA PIEDI / FEET TYPE



Piede Peak in metallo
finitura grigio di serie, finitura
cromo o manganese optional
Standard grey finish
metal Peak foot,
chrome or manganese finish
optional



Piede Glam in metallo
finitura grigio, cromo o
manganese optional
Optional grey, chrome
or manganese finish
metal Glam foot



Piede Hop in metallo
finitura manganese optional
Optional manganese finish
metal Hop foot

living.chic

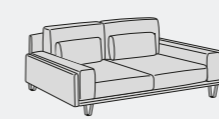
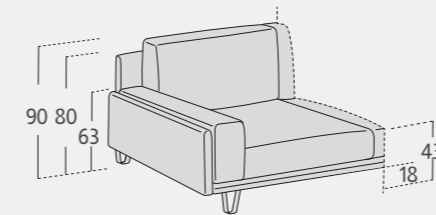

Divano
L 203 P 98 H 90

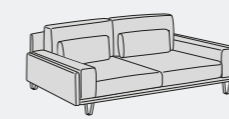

Divano
L 223 P 98 H 90

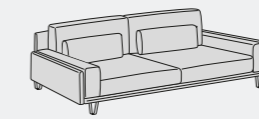

Divano
L 243 P 98 H 90

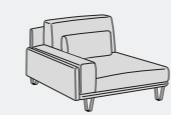

Poltrona laterale dx/sx
L 105 P 98 H 90

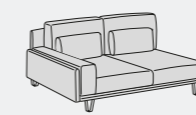

Divano laterale dx/sx
L 155 P 98 H 90

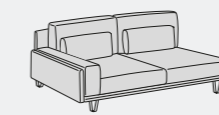

Divano laterale dx/sx
L 175 P 98 H 90

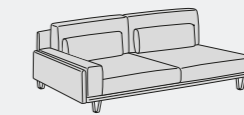

Divano laterale dx/sx
L 195 P 98 H 90

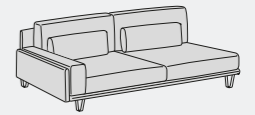

Divano laterale dx/sx
L 215 P 98 H 90

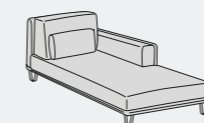

Panchetta dx/sx
L 113 P 163 H 90

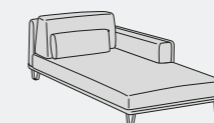

Panchetta maxi dx/sx
L 123 P 163 H 90

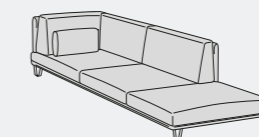

Penisola angolare
c/pouff dx/sx
L 98 P 235 H 90



Angolo retto
L 98 P 98 H 90



Pouff
L 75 P 65 H 43



Pouff
L 95 P 95 H 43



Pouff monoscocca
L 75 P 65 H 43

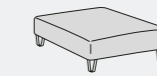

Pouff monoscocca
L 95 P 95 H 43

TIPOLOGIA PIEDI / FEET TYPE



Piede Glam in metallo
finitura grigio di serie,
finitura cromo o
manganese optional
Standard grey finish
metal Glam foot,
chrome or manganese
finish optional



Piede Hop in metallo
finitura manganese
optional
Optional manganese
finish metal Hop foot



Piede Peak in metallo
finitura grigio, cromo o
manganese optional
Optional grey, chrome
or manganese finish
metal Peak foot

living.minimal

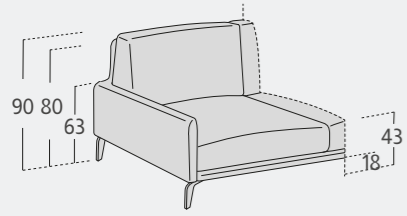

Poltrona
L 93 P 98 H 90



Divano
L 163 P 98 H 90



Divano
L 183 P 98 H 90



Divano
L 203 P 98 H 90

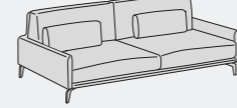

Divano
L 243 P 98 H 90



Poltrona laterale dx/sx
L 85 P 98 H 90



Divano laterale dx/sx
L 155 P 98 H 90



Divano laterale dx/sx
L 175 P 98 H 90



Divano laterale dx/sx
L 195 P 98 H 90



Panchetta dx/sx
L 93 P 163 H 90



Panchetta maxi dx/sx
L 103 P 163 H 90

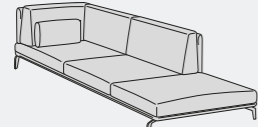

Penisola angolare
c/pouff dx/sx
L 98 P 235 H 90



Angolo retto
L 98 P 98 H 90



Pouff
L 75 P 65 H 43



Pouff
L 95 P 95 H 43



Pouff monoscocca
L 75 P 65 H 43



Pouff monoscocca
L 95 P 95 H 43

INFORMAZIONI TECNICHE / TECHNICAL INFORMATION

Struttura pianale: legno lamellare e agglomerato completamente rivestita in vellutino accoppiato a fibra di poliestere gr 300, fissato a telaio in metallo verniciato.

Molleggio seduta: nastri elastici in fibra polipropilenica e lattice da mm 80, tesi meccanicamente.

Cuscini seduta: in poliuretano espanso indeformabile D 32, con fodera in piuma d'oca sterilizzata e fibra di poliestere suddivisa in comparti.

Cuscini schienale: in piuma d'oca sterilizzata e fibra di poliestere suddivisa in comparti, con inserto in poliuretano espanso indeformabile D 18 morbido.

Cuscino bracciolo per Living Bright e Chic: in piuma d'oca sterilizzata e fibra di poliestere suddivisa in comparti, con inserto in poliuretano espanso indeformabile D 28 morbido.

Rivestimenti: completamente sfoderabile in tessuto, parzialmente sfoderabile in pelle ed ecopelle. Nella versione con rivestimento in pelle ci potranno essere delle cuciture aggiuntive.

Structure: laminated and bonded wood, fully covered in velveteen coupled with 300 gr. polyester fiber, fixed on a chassis in painted metal.

Seat springing: elastic bands in polypropylene fiber and 80 mm latex, mechanically stretched.

Seat cushions: in D 32 non-deformable polyurethane foam, with cover in sterilized goose down and polyester fiber, divided into compartments.

Back cushions: in sterilized goose down and polyester fiber, divided into compartments, with insert in soft D 18 non-deformable polyurethane foam.

Armrest cushion for Living Bright and Chic: in sterilized goose down and polyester fiber, divided into compartments, with insert in soft D 28 non-deformable polyurethane foam.

Upholstery: fully removable in fabric, partially removable in leather or in eco-leather. In the leather version there could be additional sewings.

TIPOLOGIA PIEDI / FOOT TYPE



Piede Hop in metallo
finitura manganese di serie
Standard manganese finish
metal Hop foot



Piede Glam in metallo
finitura grigio, cromo o
manganese optional
Optional grey, chrome
or manganese
finish metal Glam foot



Piede Peak in metallo
finitura grigio, cromo o
manganese optional
Optional grey, chrome
or manganese finish
metal Peak foot

madison.

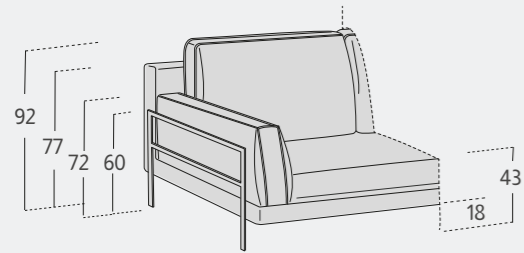

POSSIBILITÀ / POSSIBILITY

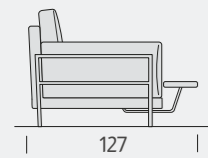

Sistema Feet
/ Feet system

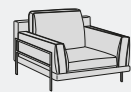

Poltrona
L 107 P 92 H 92
- Sistema Feet

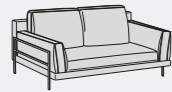

Divano
L 172 P 92 H 92
- Sistema Feet

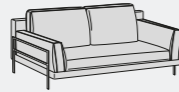

Divano
L 192 P 92 H 92
- Sistema Feet

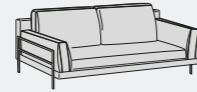

Divano
L 212 P 92 H 92
- Sistema Feet

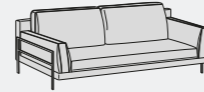

Divano
L 232 P 92 H 92
- Sistema Feet

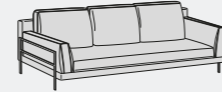

Divano
L 267 P 92 H 92
- Sistema Feet

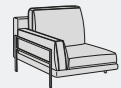

Poltrona laterale dx/sx
L 96 P 92 H 92
- Sistema Feet



Poltrona laterale dx/sx
L 106 P 92 H 92
- Sistema Feet



Poltrona laterale dx/sx
L 116 P 92 H 92
- Sistema Feet



Divano laterale dx/sx
L 151 P 92 H 92
- Sistema Feet

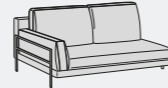

Divano laterale dx/sx
L 171 P 92 H 92
- Sistema Feet

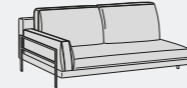

Divano laterale dx/sx
L 191 P 92 H 92
- Sistema Feet

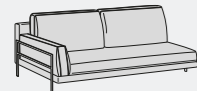

Divano laterale dx/sx
L 211 P 92 H 92
- Sistema Feet

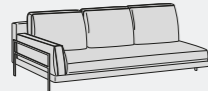

Divano laterale dx/sx
L 246 P 92 H 92
- Sistema Feet

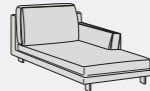

Panchetta dx/sx
L 96 P 162 H 92



Panchetta maxi dx/sx
L 106 P 162 H 92

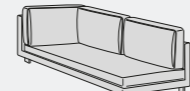

Angolo penisola dx/sx
L 92 P 207 H 92

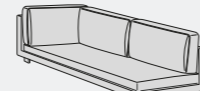

Angolo penisola dx/sx
L 92 P 227 H 92

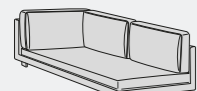

Angolo penisola maxi
dx/sx
L 112 P 207 H 92

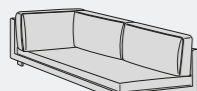

Angolo penisola maxi
dx/sx
L 112 P 227 H 92

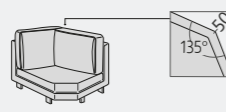

Angolo aperto
L 125 P 125 H 92

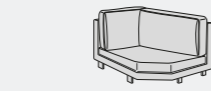

Angolo Penta dx/sx
L 118 P 128 H 92

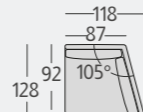

Pouff
L 130 P 130 H 43



Pouff
L 75 P 65 H 43



Pouff
L 90 P 65 H 43



Pouff Giappo
L 75 P 65 H 27

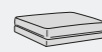

Pouff Giappo
L 90 P 65 H 27



Poggiatesta
L 65x14x14
L 75x14x14
L 85x14x14
L 95x14x14

PACCHETTO SCHIENA / BACKREST PACK

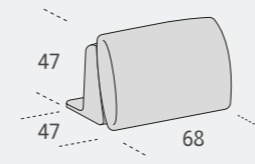

Pacchetto schiena Matrix
/ Matrix backrest pack

TIPOLOGIA PIEDE / FOOT TYPE



Piede Madison in metallo
finitura manganese di serie,
finitura anodic bronze
o nero opaco optional
Standard manganese
finish metal Madison foot,
anodic bronze or matte
black finish optional

FINITURE PIEDE / FOOT FINISHES

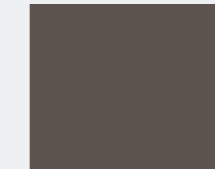

Finitura manganese
di serie
Standard manganese
finish

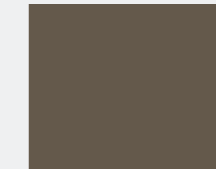

Finitura anodic bronze
optional
Optional anodic bronze
finish

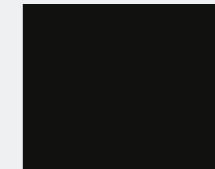

Finitura nero opaco
optional
Optional matte black
finish

INFORMAZIONI TECNICHE / TECHNICAL INFORMATION

Struttura: legno stagionato e agglomerato completamente rivestito in poliuretano espanso indeformabile e vellutino accoppiato.

Cuscini seduta: in poliuretano espanso indeformabile D 32, rivestiti in ovatta di poliestere gr 300.

Cuscini schienale: in piuma d'oca sterilizzata e fibra di poliestere suddivisi in compartimenti.

Cuscino bracciolo: in piuma d'oca sterilizzata e fibra di poliestere suddiviso in compartimenti.

Pacchetto schiena Matrix: composto da reggischienale in multistrato e nastri elastici in fibra polipropilenica e lattice da 60 mm rivestito in vellutino accoppiato gr 300, e cuscino integrato in piuma d'oca sterilizzata e fibra di poliestere suddiviso in compartimenti.

Rivestimenti: completamente sfoderabile in tessuto, parzialmente sfoderabile in pelle ed ecopelle. Nella versione con rivestimento in pelle ci potranno essere delle cuciture aggiuntive.

Sistema Feet: meccanismo elettrico in metallo, completamente sfoderabile in tessuto, non sfoderabile in pelle ed ecopelle.

Structure: seasoned and bonded wood, completely covered in non-deformable polyurethane foam and velveteen coupled.

Seat cushions: in D 32 non-deformable polyurethane foam, covered in 300 gr. polyester batting.

Back cushions: in sterilized goose down and polyester fiber, divided into compartments.

Armrest cushion: in sterilized goose down and polyester fiber, divided into compartments.

Matrix backrest pack: composed of backrest support in multilayer and elastic bands in polypropylene fiber and 60 mm latex, covered in 300 gr. velveteen coupled, and included cushion in sterilized goose down and polyester fiber, divided into compartments.

Upholstery: fully removable in fabric, partially removable in leather or in eco-leather. In the leather version there could be additional sewings.

Feet system: electric mechanism in metal, upholstery is fully removable in fabric, not removable in leather or in eco-leather.

nixon.

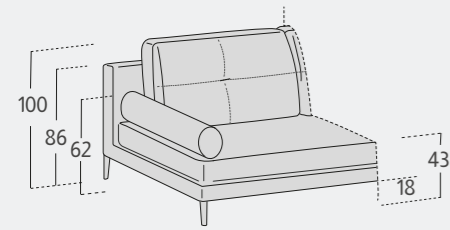

POSSIBILITÀ / POSSIBILITY

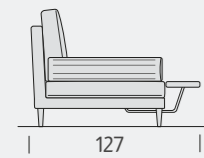

Sistema Feet / Feet system

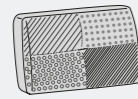

Finitura Patch / Patch finish

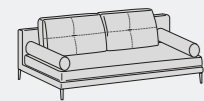

Divano L 210 P 92 H 100 - Sistema Feet

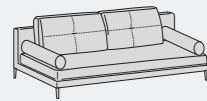

Divano L 230 P 92 H 100 - Sistema Feet

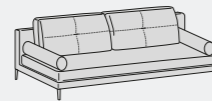

Divano L 250 P 92 H 100 - Sistema Feet

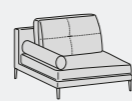

Poltrona laterale dx/sx L 105 P 92 H 100 - Sistema Feet



Poltrona laterale dx/sx L 115 P 92 H 100 - Sistema Feet



Poltrona laterale dx/sx L 125 P 92 H 100 - Sistema Feet

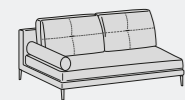

Divano laterale dx/sx L 180 P 92 H 100 - Sistema Feet

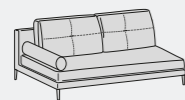

Divano laterale dx/sx L 200 P 92 H 100 - Sistema Feet

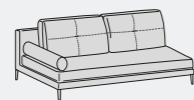

Divano laterale dx/sx L 220 P 92 H 100 - Sistema Feet



Centrale L 85 P 92 H 100 - Sistema Feet



Centrale L 130 P 92 H 100 - Sistema Feet

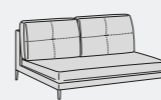

Centrale L 150 P 92 H 100 - Sistema Feet

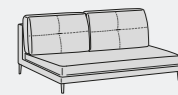

Centrale L 170 P 92 H 100 - Sistema Feet

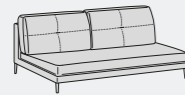

Centrale L 190 P 92 H 100 - Sistema Feet

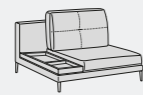

Centrale c/Jolie dx/sx L 125 P 92 H 100 - Sistema Feet

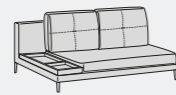

Centrale c/Jolie dx/sx L 170 P 92 H 100 - Sistema Feet



Centrale c/Jolie dx/sx L 190 P 92 H 100 - Sistema Feet

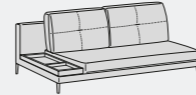

Centrale c/Jolie dx/sx L 210 P 92 H 100 - Sistema Feet

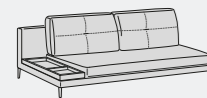

Centrale c/Jolie dx/sx L 230 P 92 H 100 - Sistema Feet

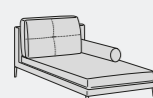

Panchetta dx/sx L 105 P 162 H 100

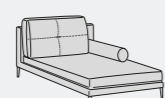

Panchetta maxi dx/sx L 115 P 162 H 100

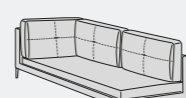

Angolo penisola dx/sx L 92 P 207 H 100

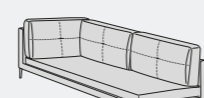

Angolo penisola dx/sx L 92 P 227 H 100

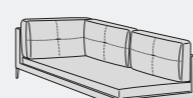

Angolo penisola maxi dx/sx L 112 P 207 H 100

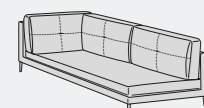

Angolo penisola maxi dx/sx L 112 P 227 H 100

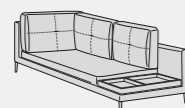

Angolo penisola c/Jolie dx/sx L 92 P 207 H 100

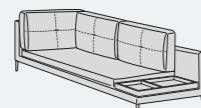

Angolo penisola c/Jolie dx/sx L 92 P 227 H 100

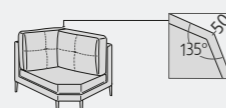

Angolo aperto L 125 P 125 H 100



Angolo Penta dx/sx L 118 P 128 H 100

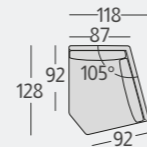

Pouff L 130 P 130 H 43



Pouff L 75 P 65 H 43



Pouff L 90 P 65 H 43



Pouff Giappo L 75 P 65 H 27

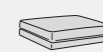

Pouff Giappo L 90 P 65 H 27



Poggiatesta L 65x14x14 L 75x14x14 L 85x14x14 L 95x14x14

PACCHETTO SCHIENA / BACKREST PACK

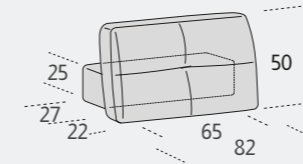

Pacchetto schiena Nixon / Nixon backrest pack

TIPOLOGIA PIEDI / FEET TYPE

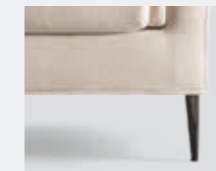

Piede Link in metallo finitura nichel nero di serie, finitura cromo optional Standard black nickel finish metal Link foot, chrome finish optional



Piede Hop in metallo finitura manganese optional Optional manganese finish metal Hop foot

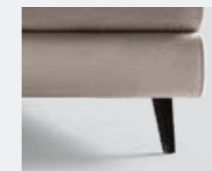

Piede Log in legno colore naturale, noce o wengè optional Optional natural, walnut or wengè colour wooden Log foot



Piede Spill in metallo finitura anodic bronze, manganese o nero opaco optional Optional anodic bronze, manganese or matte black finish metal Spill foot

FINITURA ACCESSORIO JOLIE / JOLIE ACCESSORY'S FINISH

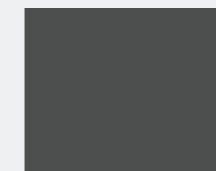

Finitura lavagna opaco Matt chalkboard finish

INFORMAZIONI TECNICHE / TECHNICAL INFORMATION

Struttura: legno stagionato e agglomerato completamente rivestita in poliuretano espanso indeformabile e vellutino accoppiato.

Cuscini seduta: in poliuretano espanso indeformabile D 32, rivestito in ovatta di poliestere gr 300.

Cuscini schienale: in piuma d'oca sterilizzata e fibra di poliestere suddivisi in compartimenti.

Cuscino bracciolo: in poliuretano espanso indeformabile D30 con barra in metallo all'interno.

Rivestimenti: completamente sfoderabile in tessuto, parzialmente sfoderabile in pelle ed ecopelle. Nella versione con rivestimento in pelle ci potranno essere delle cuciture aggiuntive.

Pacchetto schiena Nixon: reggischienale in poliuretano espanso indeformabile con inserto in metallo, cuscino schienale in piuma d'oca sterilizzata e fibra di poliestere suddiviso in compartimenti.

Structure: seasoned and bonded wood, completely covered in non-deformable polyurethane foam and velveteen coupled.

Seat cushions: in D 32 non-deformable polyurethane foam, covered in 300 gr. polyester batting.

Back cushions: in sterilized goose down and polyester fiber, divided into compartments.

Armrest cushion: in D30 non-deformable polyurethane foam with an internal metal bar.

Upholstery: fully removable in fabric, partially removable in leather or in eco-leather. In the leather version there could be additional sewings.

Nixon backrest pack: backrest support in non-deformable polyurethane foam with metal insert; backrest cushion in sterilized goose down and polyester fiber, divided into compartments.

sassy.

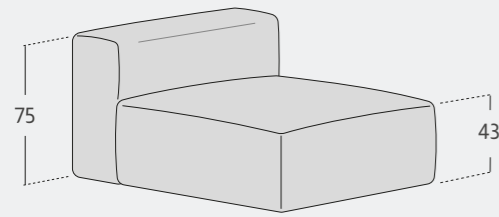

POSSIBILITÀ / POSSIBILITY

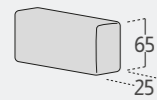
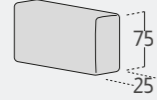
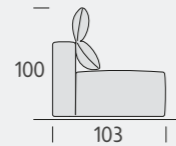
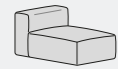
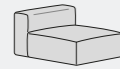
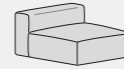
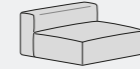
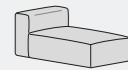
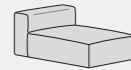
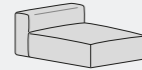
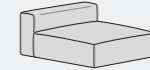
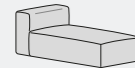
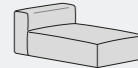
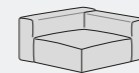
Bracciolo / Armrest
L 25 P 103 H 65Bracciolo / Armrest
L 25 P 103 H 75Schiena Comfort
/ Comfort backrestCentrale
L 73 P 103 H 75
- Schiena comfortCentrale
L 83 P 103 H 75
- Schiena comfortCentrale
L 93 P 103 H 75
- Schiena comfortCentrale
L 103 P 103 H 75
- Schiena comfortCentrale
L 73 P 146 H 75
- Schiena comfortCentrale
L 83 P 146 H 75
- Schiena comfortCentrale
L 93 P 146 H 75
- Schiena comfortCentrale
L 103 P 146 H 75
- Schiena comfortCentrale
L 73 P 166 H 75
- Schiena comfortCentrale
L 83 P 166 H 75
- Schiena comfortCentrale
L 93 P 166 H 75
- Schiena comfortCentrale
L 103 P 166 H 75
- Schiena comfortPouff
L 73 P 103 H 43Pouff
L 83 P 103 H 43Pouff
L 93 P 103 H 43Pouff
L 103 P 103 H 43Angolo retto
L 103 P 103 H 75Pouff
L 73 P 63 H 43Pouff
L 83 P 63 H 43Pouff
L 93 P 63 H 43Pouff
L 103 P 63 H 43Pouff
L 123 P 63 H 43

TIPOLOGIA PIEDE/ FOOT TYPE

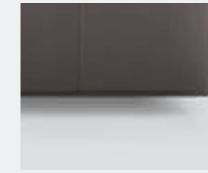

Piede in Abs con antiscivolo, effetto sospeso di serie
Standard ABS foot suspended effect, with anti-slip.

INFORMAZIONI TECNICHE / TECHNICAL INFORMATION

Struttura: legno stagionato e agglomerato con imbottitura in poliuretano espanso indeformabile.

Molleggio seduta: nastri elastici in fibra polipropilenica e lattice da mm 80, tesi meccanicamente.

Cuscini seduta e schienale: integrati nella struttura in poliuretano espanso indeformabile a quote differenziate D 35/30 rivestiti in ovatta di poliestere gr 300.

Schiena Comfort: in piuma d'oca sterilizzata e fibra di poliestere suddivisi in comparti con supporto in metallo nero opaco.

Rivestimenti: completamente sfoderabile in tessuto, non sfoderabile in ecopelle. Non previsto in pelle.
Tessuto o ecopelle accoppiato a materiale tecnico in fibra di poliestere.

NOTE IMPORTANTI

I vari elementi non prevedono ganci di giunzione in quanto i piedi antiscivolo ne garantiscono la stabilità.

Structure: seasoned and bonded wood with padding in non-deformable polyurethane foam.

Seat springing: elastic bands in polypropylene fiber and 80 mm latex, mechanically stretched.

Seating and back cushions: included in the structure, in non-deformable polyurethane foam at different heights D 35/30, covered in 300 gr. polyester batting.

Comfort backrest: in sterilized goose down and polyester fiber, divided into compartments with matte black metal support.

Upholstery: fully removable in fabric, not removable in eco-leather. Leather version is not available.
Fabric or eco-leather are coupled with a technical material in polyester fiber.

IMPORTANT NOTES:

The various elements do not provide joint hooks, since the feet with anti-slip guarantee the stability.



Per posizionare la schiena Comfort inserire la parte in metallo tra seduta e scocca.
To place the Comfort backrest insert the metal part in between the structure and the seating.

SAMOA[®]
DIVANI E IMBOTTITI

SAMOA SRL

31014 Colle Umberto (TV) - ITALY
Via 1° Maggio, 9/11 (Z.I.)

Tel. +39 0438 388179
Fax +39 0438 430482

www.samoativani.com
www.bsideletti.it
info@samoativani.com



SAMOA produce con energia pulita.
SAMOA produces with clean energy.



SAMOA produce esclusivamente in Italia.
SAMOA produces exclusively in Italy.

CREDITS:

Design
Centro stile Samoa, Treviso

Photo, 3D, styling & graphic design
www.linkfoto.it

Print
Grafiche Antiga



stampato
con il sole

SAMOA[®]
DIVANI E IMBOTTITI